



Working to Perfect the Flow of Energy

PJM Manual 12:
Balancing Operations

Revision: 254

Effective Date: [April 3, 2012](#)

[Endorsed by RPSTF 7/31/12](#)

Prepared by Adam Keech
Dispatching

© PJM 20124



PJM Manual 12: Balancing Operations

Table of Contents

Table of Contents	ii
Table of Exhibits	v
Approval	1
Current Revision	1
Introduction	2
ABOUT PJM MANUALS.....	2
ABOUT THIS MANUAL.....	2
<i>Intended Audiences</i>	2
<i>References</i>	3
USING THIS MANUAL	3
<i>What You Will Find In This Manual</i>	3
Section 1: Overview	4
1.1 SCOPE AND PURPOSE OF DISPATCHING.....	4
1.2 PJM RESPONSIBILITIES	6
1.2.1 <i>PJM Communications</i>	7
1.3 PJM MEMBER RESPONSIBILITIES	7
1.3.1 <i>Market Buyers</i>	7
1.3.2 <i>Market Sellers</i>	7
1.3.3 <i>Load Serving Entities</i>	8
Section 2: Dispatching Tools	9
2.1 CONTROL CENTER TOOLS.....	9
2.1.1 <i>EMS Applications</i>	9
2.1.2 <i>PC Applications</i>	10
2.1.3 <i>Ancillary Tools</i>	11
Section 3: System Control	12
3.1 ADJUSTING PJM BALANCING AREA-SCHEDULED RESOURCES	12
3.1.1 <i>PJM Area Control Error</i>	12
3.1.2 <i>PJM Control Implementation</i>	16
3.1.3 <i>PJM Member Control Implementation</i>	19
3.2 TIME ERROR.....	21
3.2.1 <i>Time Error Correction Notification</i>	21
3.3 EXTERNAL TRANSACTIONS SCHEDULING.....	22
3.3.1 <i>Overview of External Transaction Scheduling</i>	22
3.4 EXTERNAL TRANSACTION SCHEDULING BUSINESS RULES.....	23
3.4.1 <i>PJM Contact Information</i>	23
3.4.2 <i>External Transaction Timing Requirements</i>	23
3.4.3 <i>General Information</i>	25
3.4.4 <i>Data Requirements</i>	25
3.4.5 <i>Ramp Limits</i>	25
3.4.6 <i>OASIS Business Rules</i>	26
3.4.7 <i>Entering Ramp Reservations</i>	29
3.4.8 <i>Entering Schedules</i>	29



3.4.9 Entering Real-Time with Price Schedules	30
3.4.10 Entering Two-Settlement Schedules	30
3.4.11 Transaction Validations, Verification and Checkout	30
3.5 INADVERTENT INTERCHANGE	32
3.5.1 Correcting for Accumulation of Inadvertent Interchange	33
3.5.2 Measurements and Compliance	34
Section 4: Providing Ancillary Services	35
4.1 RESERVES	35
4.1.1 Monitoring Reserves	35
4.1.2 Loading Reserves	36
4.2 SHARED RESERVES	38
4.2.1 Payback	39
4.2.2 Restoring Reserves	39
4.3 VACAR RESERVE SHARING	40
4.4 REGULATION	40
4.4.1 PJM RTO Regulation Market Obligations	41
4.4.2 Regulation Signals	43
4.4.3 Determining Regulation Assignment	44
4.4.4 Dispatching Regulation	45
4.5 QUALIFYING REGULATING RESOURCES	48
4.5.1 Regulation Test	48
4.5.2 Certifying Regulating Resource	51
4.5.3 Certifying Multiple Combustion Turbines or Hydro Units at a Single Site	53
4.5.4 Increasing Regulation Capability on a Resource	53
4.5.5 Continued Verification of Regulation Resources	54
4.6 BLACK START SERVICE	58
4.6.1 Additional PJM Requirements	59
4.6.2 Restoration Assumptions	60
4.6.3 Jurisdiction	60
4.6.4 Definitions	60
4.6.5 Objectives of Determining Black Start Criticality	60
4.6.6 Assumptions	61
4.6.7 Minimum Critical Unit Requirements	61
4.6.8 Critical Unit Restrictions for Eligible Compensation under the PJM Black Start Service	61
4.6.9 Exceptions	61
4.6.10 Product Description	62
4.6.11 Generator Owner's Commitment	62
4.6.12 Performance Standards	63
4.6.13 PJM Obligations	64
4.6.14 Testing	64
4.6.15 Testing and Training Standards and Records	64
4.6.16 Non-performance	65
Section 5: Transmission Facility Control	67
5.1 CORRECTIVE CONTROL STRATEGIES	67
5.2 REACTIVE LIMITATION CONTROL	69
5.3 VOLTAGE CONTROL	70
5.3.1 Action in a Low-Voltage Situation	71
5.3.2 500 kV System Voltage Below 500 kV	71
5.3.3 Action in a High-Voltage Situation	72
5.4 THERMAL OVERLOADED TRANSMISSION	72
5.4.1 Transaction Curtailment	73
5.4.2 Generation Redispatch	73
5.4.3 Operating Mode Change Procedure	73



5.4.4 Generation Redispatch (Non-Market Facilities).....	74
Attachment A: PJM Instantaneous Reserve Check (IRC).....	75
IRC - DEFINITIONS OF TERMS / CALCULATIONS	75
Attachment B: Transmission Constraint Control Guidelines.....	78
B.1 NON-COST MEASURES	78
B.2 GENERATION REDISPATCH	78
B.3 ANALYZING AND CONTROLLING NON-MARKET BES FACILITIES	79
B.3.1 Outage Approval Process for BES facilities:	80
B.3.2 Outage Approval Process for non-market BES Facilities:.....	80
B.3.3 Resolving Modeling Differences:	80
B.3.4 Real-time Controlling Actions:	81
B.3.5 Real-time Controlling Actions:	81
B.3.6 Maintaining System Reliability:.....	82
Attachment C: PJM Black Start Test Report Form.....	84
Attachment D: Disturbance Control Performance/Standard	85
Attachment E: PJM REPORTING OF NERC BAL Standard	87
PJM Manual 12 Revision History.....	98



Table of Exhibits

EXHIBIT 1: DISPATCHING TIMELINE 5
EXHIBIT 2: CALCULATION OF PJM ACE 13
EXHIBIT 3: PJM REGULATION SIGNALS 17
EXHIBIT 4: CALCULATION OF DISPATCH PRICE AND MW SIGNALS 18
EXHIBIT 5: RESOURCE DISPATCHING 19
EXHIBIT 6: PJM MEMBER INTERFACE 20
EXHIBIT 7: EXAMPLE RAMP CALCULATION 26
EXHIBIT 8: ON-PEAK TRANSMISSION SERVICE OVER 16 HOUR PERIOD EXAMPLE 27
EXHIBIT 9: ON-PEAK TRANSMISSION SERVICE OVER 18 HOUR PERIOD EXAMPLE 28
EXHIBIT 10: OFF-PEAK MONDAY-FRIDAY TRANSMISSION SERVICE EXAMPLE 28
EXHIBIT 11: OFF-PEAK SATURDAY-SUNDAY TRANSMISSION SERVICE EXAMPLE 28
EXHIBIT 12: LIMIT RELATIONSHIP FOR REGULATION 42
EXHIBIT 13: AREA REGULATION ASSIGNMENT 46
EXHIBIT 14: REGULATION TEST PATTERN 49
EXHIBIT 15: CORRECTIVE CONTROL STRATEGIES 68
EXHIBIT 16: POWER SYSTEM LIMITS 69
EXHIBIT 17: PJM INSTANTANEOUS RESERVE CHECK TERMS & RELATIONSHIPS 75
EXHIBIT 18: DEFINITIONS OF PJM INSTANTANEOUS RESERVE CHECK TERMS 76
EXHIBIT 19: SAMPLE PJM INSTANTANEOUS RESERVE CHECK FORM 77



Approval

Approval Date: ~~04/03/2012~~
Effective Date: ~~04/03/2012~~

Adam Keech, Manager Dispatch

Current Revision

Revision 25 (MM/dd/yyyy)b

Revision 24 (04/03/2012):

- ~~Attachment B: Updated language regarding PJM issuing PCLLRWs for non-market facilities. Added language regarding post-contingency low-voltage PCLLRWs.~~



Introduction

Welcome to the **PJM Manual for Balancing Operations**. In this Introduction, you will find information about PJM manuals in general, an overview of this PJM manual in particular and information on how to use this manual.

About PJM Manuals

The PJM manuals are the instructions, rules, procedures, and guidelines established by PJM for the operation, planning, and accounting requirements of the PJM RTO and the PJM Energy Market. The manuals are grouped under the following categories:

- Transmission
- PJM Energy Market
- Generation and transmission interconnection
- Reserve
- Accounting and billing
- PJM administrative services

For a complete list of all PJM manuals, go to www.pjm.com and select “Manuals” under the “Documents” pull-down menu.

About This Manual

The PJM Manual for **Balancing Operations** is one of a series of manuals within the PJM Energy Market manuals. This manual focuses on the activities that occur in the real-time operation of the PJM Energy Market. The manual describes how PJM dispatches and controls Capacity Resources and how PJM monitors transmission facilities. It also describes how PJM provides Ancillary Services.

PJM Manual for Balancing Operations consists of five sections and six attachments. Both the sections and the attachments are listed in the table of contents beginning on page ii.

Intended Audiences

The intended audiences for **PJM Manual for Balancing Operations** are:

- *PJM Members* – Any participant requesting to purchase or sell energy to or from PJM Energy Market and any participant that schedules bilateral sales or purchases.
- *PJM operations staff* – PJM operations staff monitors the performance of the Capacity Resource.
- *PJM dispatchers* – PJM dispatchers are responsible for reliable operation of the PJM RTO and posting information in the OASIS. “PJM dispatchers” refers to PJM dispatchers located in all PJM control centers.
- *Transmission Owners/Generation Owners* – The Transmission Owners/Generation Owners system operators/ dispatchers direct operation of the



local facilities and communicate with PJM dispatcher to coordinate operation of the Bulk Power Electric Supply system facilities.

References

The references to other documents that provide background or additional detail directly related to the ***PJM Manual for Balancing Operations*** are:

- NERC Operating Manual
- PJM Manual for [Pre-Scheduling Operations \(M-10\)](#)
- PJM Manual for [Scheduling Operations \(M-11\)](#)
- PJM Manual for [Operating Agreement Accounting \(M-28\)](#)
- PJM Manual for [Emergency Operations \(M-13\)](#)

Using This Manual

We believe that explaining concepts is just as important as presenting the procedures. This philosophy is reflected in the way we organize the material in this PJM manual. We start each section with an overview. Then, we present details and procedures or references to procedures found in other PJM manuals. The following provides an orientation to the manual's structure.

What You Will Find In This Manual

- A table of contents that lists two levels of subheadings within each of the sections and attachments
- An approval page that lists the required approvals and a brief outline of the current revision
- Sections containing the specific guidelines, requirements, or procedures including PJM actions and PJM Member actions
- Attachments that include additional supporting documents, forms, or tables
- A section at the end detailing all previous revisions of this PJM manual.



Section 1: Overview

Welcome to the *Overview* section of the ***PJM Manual for Balancing Operations***. In this section, you will find the following information:

- A description of the scope and purpose of dispatching (see “Scope and Purpose of Dispatching”).
- A list of PJM dispatching responsibilities (see “PJM Responsibilities”).
- A list of the PJM Member’s dispatching responsibilities (see “PJM Member Responsibilities”).

1.1 Scope and Purpose of Dispatching

Operation of the PJM RTO involves many activities that are performed by different operating and technical personnel. These activities occur in parallel on a continuous basis, 24 hours a day and can be grouped into three overlapping time frames:

- pre-scheduling operations
- scheduling operations
- dispatching operations

In the ***PJM Manual for Balancing Operations*** we focus mainly on the activities that take place in the current hour of the Operating Day. The following exhibit presents the dispatching activities in the form of a timeline. The reference point for the timeline is the “Operating Day,” recognizing that every new day becomes an Operating Day. This timeline-type of description is used throughout this PJM Manual.

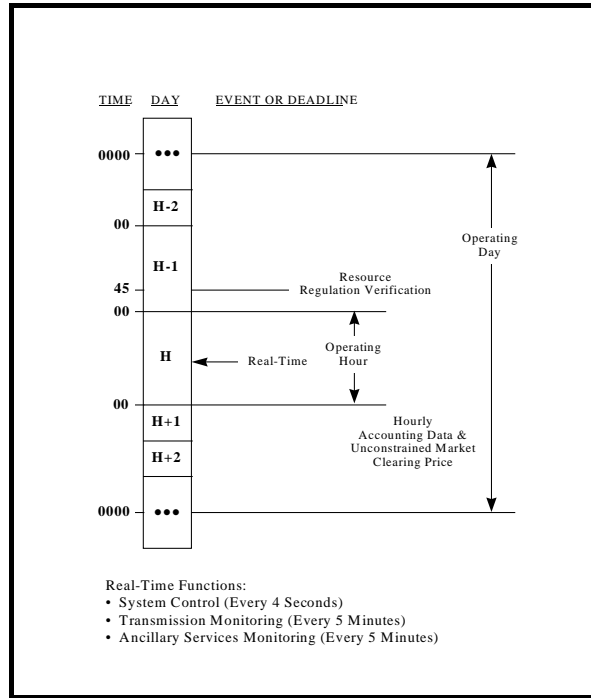

Exhibit 1: Dispatching Timeline



Dispatching includes system control, Ancillary Service monitoring, and transmission system monitoring and control. During the dispatching process, PJM implements and adjusts the Current Operating Plan, which is developed during the scheduling process, to maintain reliability and minimize the cost of supplying the energy, reserves, and other services that are required by the PJM Members and the operation of the PJM RTO. The Current Operating Plan is developed within the guidelines and rules of the Two Pass System.

In this manual we make no special distinction between the terms “price” and “cost”. PJM Members submit their bids accordingly to either actual cost or offer price as designated by PJM for each generation resource. For specific information as to the use of price and cost, refer to the Markets Database section in the ***PJM Manual for Pre-Scheduling Operations***.

1.2 PJM Responsibilities

PJM monitors and controls the PJM RTO such that the least-cost means of satisfying the projected hourly energy, Operating Reserves, and other Ancillary Services requirements of the Market Buyers, including the reliability requirements of the PJM Balancing Area, are met. Specifically, PJM's responsibilities to support dispatching activities include:

- Directing PJM Members to adjust the output of any PJM RTO-Scheduled Resource; commit unscheduled PJM RTO resources; cancel selection of PJM Balancing Area-Scheduled Resources
- Operating the PJM RTO transmission system in accordance with NERC and regional reliability council standards and procedures.
- Committing the most cost efficient Regulation and Synchronized Reserve resources available
- Implementing the PJM/MISO Congestion Management procedure for congested transmission facilities external to PJM RTO.
- Implementing the NERC Transmission Loading Relief (TLR) procedure as necessary to provide relief to external or internal transmission facilities.
- Verifying the accuracy of LMP data during constrained/unconstrained operations.
- Implementation of Emergency Procedures in accordance with PJM Manual M-13, Emergency Operations.

Note: Synchronized Reserve: Section 1.3.33B.01 of the PJM Operating Agreement (OA) defines Synchronized Reserves as the reserve capability of generation resources that can be converted fully into energy or Demand Resources whose demand can be reduced within ten minutes from the request of the Office of the Interconnection dispatcher, and is provided by equipment that is electrically synchronized to the Transmission System. Synchronized Reserves are supplied from 10 minute synchronized generating resources (i.e., **Synchronous** Reserves) and 10-minute demand side response resources.



1.2.1 PJM Communications

PJM dispatching operations are conducted from two control centers. The dispatchers in both control centers work together as a single team. The Shift Supervisor provides real time leadership over dispatchers in both control centers. Communications between the control centers is facilitated through the use of closed circuit TV through which dispatchers can communicate visually and orally in real time with their counterparts and supervision. System monitoring and control responsibilities are shared between the control centers.

1.3 PJM Member Responsibilities

Only Market Buyers and Market Sellers are eligible to submit offers and purchase energy or related services in the PJM Energy Market. The PJM Members include the Market Buyers and the Market Sellers.

1.3.1 Market Buyers

There are two general types of Market Buyers:

1. Internal Market Buyer - An Internal Market Buyer is a buyer that is purchasing energy from the PJM Energy Market for consumption by end-users that are located inside the PJM RTO. An Internal Market Buyer may be further classified as a Generating Market Buyer. A Generating Market Buyer is an Internal Market Buyer that owns or has contractual rights to the output of generation resources which are capable of serving the Market Buyer's load in the PJM RTO or selling energy-related services in the PJM Energy Market or elsewhere.
2. External Market Buyer - An External Market Buyer is a Market Buyer that is making purchases of energy from the PJM Energy Market for consumption by end-users that are located outside the PJM RTO.

The Internal Market Buyers' dispatching responsibilities include:

- satisfying its Regulation obligation from its own resources, by contractual arrangement with another PJM Member, or by purchases from the PJM Energy Market

1.3.2 Market Sellers

A Market Seller is a PJM Member that demonstrates to PJM that it meets the standards for the issuance of an order mandating the provision of transmission service under Section 211 of the Federal Power Act, submits an application to PJM, and is approved. By definition, all Market Buyers become Market Sellers upon approval of their applications.

Market Sellers dispatching responsibilities include:

- ensuring each Capacity Resource complies with energy dispatching signals and instructions that are issued by PJM
- complying with Regulation signals and instructions that are issued by PJM



1.3.3 Load Serving Entities

A Load Serving Entity (LSE) is any entity that has been granted authority or has an obligation pursuant to state or local law, regulation, or franchise to sell electric energy to end-users that are located within the PJM RTO. An LSE may be a Market Buyer or a Market Seller.



Section 2: Dispatching Tools

Welcome to the *Dispatching Tools* section of the **PJM Manual for Balancing Operations**. In this section you will find the following information:

- A description of PJM Control Center tools used for dispatching and operations (see “*Control Center Tools*”).
- A description of the information that is passed on to market accounting (see “*Accounting Information*”).

2.1 Control Center Tools

The tools that are currently used by PJM operations staff are described according to three categories: EMS computer applications, PC applications, and ancillary tools. EMS is further described in PJM Manual 1, Section 1, “PJM Systems.”

2.1.1 EMS Applications

- Automatic Generation Control (AGC) — This program runs every two seconds, calculating Area Control Error (ACE), Area Regulation (AR), and economic dispatch.
- Security Analysis (SA) – This program runs approximately every 1-2 minutes and calculates the simulated post-contingency flows on a large number of monitored facilities on the PJM system for the loss of selected contingencies. An EMS Alarms is generated for any SA post-contingency value that goes beyond, or falls back under, 100% of the monitored facility’s Normal Limit (NL) of 80% of the monitored facility’s Long Term Limit (LT). Any facility with an SA value that is greater than 100% of the NL, or 80% of the monitored facility’s LT, will be monitored in the SA Themals display of PJM’s RTNA package.
- State Estimator (SE) – This program runs approximately every minute and provides simulated flows for the PJM system based on current topology and the availability of telemetered data. SE is used to provide the input to the market systems. An EMS Alarm is generated for any SE value that goes beyond, or falls back under 92% of the monitored facility’s NL. Any facility with an SE value that is greater than 92% of the NL will be monitored in the Actual Thermal Overload display, as well as the SA Themals display, of PJM’s RTNA Package.
- Transfer Limit Calculator (TLC) – This program runs approximately every 4 – 5 minutes and establishes transfer limits for selected interfaces on the PJM system. The process that the application uses is to establish the voltage collapse point for these interfaces and applying a suitable margin from the collapse point as the safe operating limit. TLC facilities are monitored continuously on PJM’s RTO Critical Information display. In addition, an EMS Alarm is generated whenever the SE MW flow for a transfer interface exceeds the Recommended Limit as calculated by TLC.



2.1.2 PC Applications

- Markets Database —This database is used by the Two-Settlement and Market-Based Regulation Systems. Market Participants update the MDB continuously via XML and Web-based interfaces.
- Dispatch Management Tool (DMT) — The DMT enables PJM Dispatchers to manage resource information, transmission constraint information and administer the Regulation Market. The DMT automatically logs resource status changes and provides an electronic source of logging information for Market Settlements.
- Real-Time Security Constrained Economic Dispatch (RT-SCED) — This application calculates Security Constrained Economic Dispatch solutions for presentation to the dispatchers. The dispatchers then select the best solution that utilizes least-cost dispatch while simultaneously controlling active transmission constraints.
- Intermediate-Time Security Constrained Economic Dispatch (IT-SCED) – this application utilizes projected system conditions to calculate commit/decommit resources on the system and provide a forward-looking dispatch trajectory for presentation to the dispatchers.
- eDART — Dispatcher Applications and Reporting Tool. Internet based system that allows communication of system information between PJM and member company dispatchers, i.e. Generation and Transmission Outage Tickets.
- Resource Scheduling and Commitment (RSC) — This program is used to schedule generation resources for up to a week in advance.
- eDart Generation Checkout – This program compares unit schedule availability/bid data in eMarket, unit outages submitted via Generator Ticket (eDart) and stated capability to ensure accurate market data and capacity/reserve projections.
- Hydro Calculator — This program is used to schedule and optimize hydro generating resources located on the Susquehanna River.
- Scheduling Coordinator's Tool — Updates day-ahead generation forecasts and schedules from market databases with additional data from various input sources. This tool is utilized to project system reserves.
- Transaction Management System (TMS) — Database used by PJM Dispatchers and Transaction Coordinators to manage transaction information.
- Enhanced Energy Scheduler (EES) — Internet based system that allows PSE's to submit, revise, and review energy schedules.
- Interchange Distribution Calculator (IDC) — IDC is a NERC-sponsored program, used in the Eastern Interconnection for the purpose of managing transactions. All interchange transactions are modeled in the IDC and the IDC calculates flow impacts of these transactions on each flowgate. If flow relief on any of these flowgates becomes necessary, the IDC is used to communicate which transactions will be modified or curtailed to provide the relief in accordance with business rules established in the NERC TLR procedure.



- Reliability Coordinator Information System (RCIS) — Internet based system used to exchange operating information among Reliability Coordinators and Balancing Areas.
- Smartlog – Database logging tool used by dispatch position to log system events. This tool contains bridges from various systems to partial automate the logging process.
- ALL-CALL — Used by PJM operations staff to simultaneously disseminate information to transmission and generation control centers.
- eData — Internet based system that allows PJM Dispatcher and participants to view current and projected system data and emergency procedures information.
- PI Process Book / Dataline – visualization tool utilized to display telemetered data.
- [Performance Score Calculation Engine \(PSCE\) – is a .NET application that calculates the hourly performance score of a resource's regulation response compared to the regulation signal sent by PJM.](#)

2.1.3 Ancillary Tools

- Video Graphic Recorders (VGRs) —VGRs are used to display and record the following:
 - LSE net generation, interchange information, control information, and other critical operating data
 - Analog point data
 - Informational TV — This TV is used to obtain weather and Emergency information from selected local network and cable channels.
 - Weather Data — Weather reports are printed from the Internet, as posted by the vendor.
 - Direct Phone Lines — Direct telephone line communication is available between PJM, the Local Control Centers, LSEs and between PJM and adjacent Balancing Areas.
 - Dynamic Mapboard — The dynamic mapboard displays selected system data; status of lines, transformers, capacitors, and generators; and the results of security analysis of the bulk power transmission system.
 - Racal Recording Device — Used to record all phone conversations from dispatching and scheduling positions for documentation.
 - Satellite Communications – Push-to-talk all-call and direct point-to-point satellite communications exists with PJM participants and participating external entities as back-up communications.
 - Phones/cell phones – Used for back-up communications.



Section 3: System Control

Welcome to the *System Control* section of the **PJM Manual for Balancing Operations**. In this section, you will find the following information:

- How PJM adjusts PJM RTO-Scheduled Resources (see “*Adjusting PJM Balancing Area-Scheduled Resources*”).
- How PJM corrects for time error (see “*Time Error*”).
- How PJM corrects for accumulated inadvertent interchange (see “*Inadvertent Interchange*”).

PJM, as the RTO, operated to maintain interconnection steady – state frequency within defined limits by balancing real power demand and supply in real time (per NERC Standard Bal-001-0, “Real Power Balancing Control Performance,” and ensures, as the Balancing Authority, its ability to utilize reserves to balance resources and demand and return interconnection frequency within defined limits following a reportable disturbance (per BAL-002-0, “Disturbance Control Performance”). Specifics are discussed as follows.

3.1 Adjusting PJM Balancing Area-Scheduled Resources

The PJM RTO must operate sufficient generating capacity under automatic control to meet its obligation to continuously balance its generation and interchange schedules with its load. It is also required to provide its contribution to frequency Regulation for the Eastern Interconnection.

Frequency deviates from schedule because actual tie line power flow does not continuously match scheduled tie line power flow. This imbalance must be minimized, so as not to impose the PJM RTO’s control requirements on the interconnected system. Area Control Error (ACE) is a value that defines how well the PJM Balancing Area is meeting its obligation.

PJM frequency source under primary control is based on use of a Global Positioning System (GPS) based “truetime” device which is linked into the EMS control system providing 2 second signal input for continuous frequency monitoring. The dispatcher has the ability to change frequency source within EMS should the primary source become disabled. Should there be a need to control an ACE in multiple zones due to extreme operations, frequency sources can be selected by generation control zones as set up in EMS.

3.1.1 PJM Area Control Error

Area Control Error is a measure of the imbalance between sources of power and uses of power within the PJM RTO. This imbalance is calculated indirectly as the difference between scheduled and actual net interchange, plus the frequency bias contribution to yield ACE in megawatts. Two additional terms may be included in ACE under certain conditions--the time error bias term and PJM dispatcher adjustment term (manual add). These provide for automatic inadvertent interchange payback and error compensation, respectively.

The sign convention for power flow used at PJM is positive for power flow into PJM, in contrast to the NERC sign convention, in which power flow into a Balancing area is negative. This has been carried over into the PJM ACE calculation, which results in a positive ACE representing overgeneration and a negative ACE representing undergeneration. Exhibit 3 shows the calculation of PJM ACE in block diagram form.

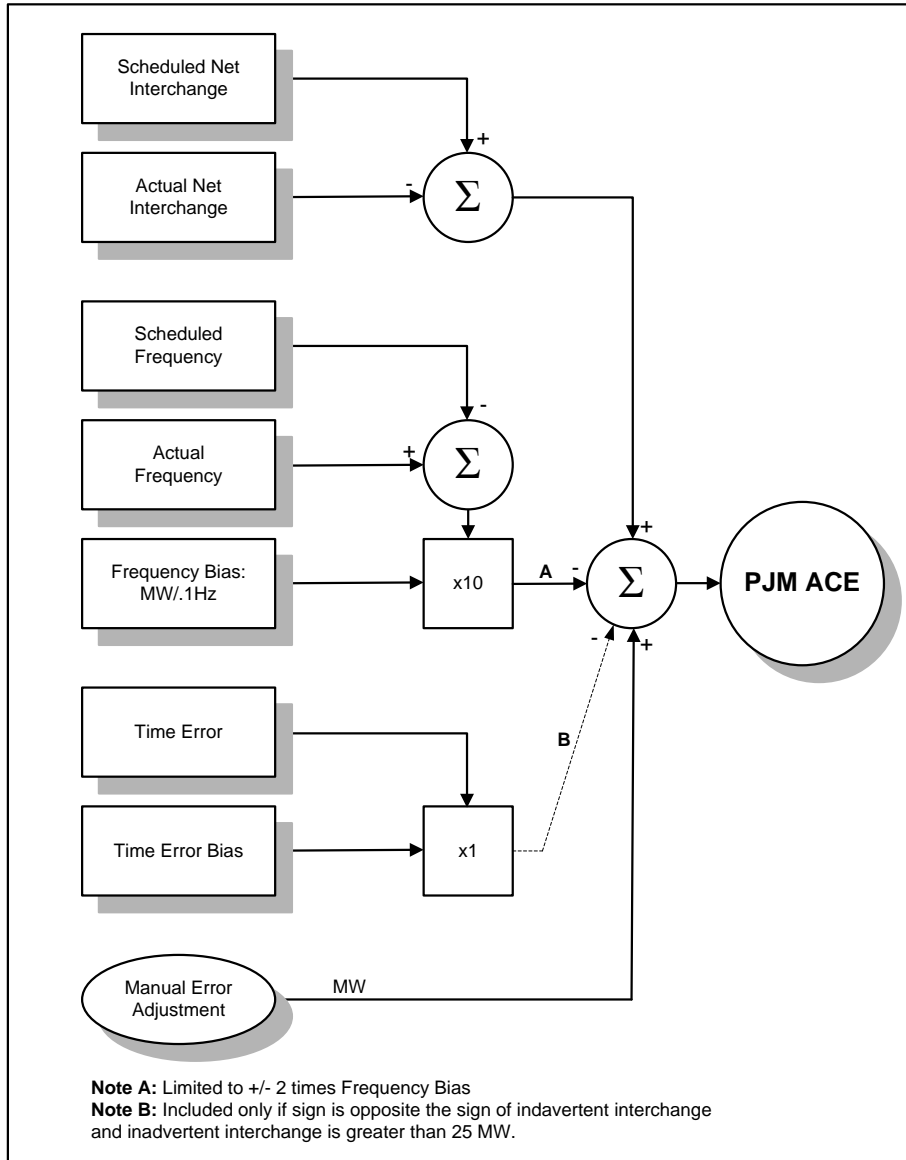

Exhibit 2: Calculation of PJM ACE



Per BAL-001-0, "Real Power Balancing Control Performance,"

$$Ace = (NI_A - NI_S) - 10B(F_A - F_S) - I_{ME}$$

where:

- NI_A is the algebraic sum of actual flows on all tie lines (i.e., Actual Net Interchange)
- NI_S is the algebraic sum of scheduled flows on all tie line (i.e., Scheduled Net Interchange)
- B is the Frequency Bias Setting (MW/0.1 Hz) for the Balancing Authority. The constant factor of 10 converts the frequency setting to MW/ Hz
- F_A is the actual frequency
- F_S is the scheduled frequency
- I_{ME} is the meter error correction factor

ACE Control Modes

There are three modes of control available to PJM dispatcher for the operation of the PJM RTO.

- Flat Frequency Control — Flat frequency control utilizes only power system frequency as the controlling parameter. This mode of control only responds to frequency deviations and does not adjust operations for any interconnection tie line schedule deviations. This mode is applicable only to those instances when the PJM Balancing Area becomes isolated from the Eastern Interconnection.
- Flat Tie Line Control — Flat tie line control utilizes only interconnection tie line flow as the controlling parameter. This mode of control only responds to net tie flow deviations and does not adjust operation for any frequency deviations. This mode is limited to special circumstances when the PJM Balancing Area desires to maintain a given net interchange flow and the power system frequency is stable and being controlled by other Balancing Areas.
- Tie Line Bias Control — Tie line bias control is the most widely used mode of control for multi- Balancing Area power systems. This mode of control responds to both frequency and net tie line flow deviations. Exhibit 4 shows all of the calculations for tie line bias control. The frequency bias factor for the PJM RTO is set by Interconnection Agreement that is at least 1% of the yearly peak value and accomplishes the following:
 - Compensates for automatic governor action so that ACE does not "undo" the changes in generator output due to frequency fluctuations.
 - Compensates for any lack of PJM governor response by calculating an ACE that produces the PJM RTO's agreed upon share of frequency support to the Eastern Interconnection.



NERC Control Performance Standard

The PJM RTO operates in accordance with NERC Resource and Demand Balancing (i.e. BAL) standards to ensure its capability to utilize reserves to balance resources and demand in real-time and to return Interconnection frequency within defined limits following a Reparable Disturbance. PJM satisfies the BAL standards by maintaining sufficient generating capacity under automatic control to satisfy its frequency regulation obligation as a member of the Eastern Interconnection. NERC establishes definitive measures of control performance. These control performance standards are documented in the NERC in numerous BAL standards. The NERC Control Performance Standards (CPS) as presented in BAL-001-0, "Real Power Balancing Control Performance" define a standard of minimum control performance for each Balancing Area. The standards are summarized as follows:

- Continuous Monitoring — Each Balancing Area monitors its control performance on a continuous basis against two standards:
- Standard One - CPS1 — Over a year, the average of the clock-minute averages of a Balancing Area's ACE divided by minus 10 B (where B is Balancing Area frequency bias) times the corresponding clock-minute averages of the Interconnection's frequency error must be less than a specific limit. This limit, ' ϵ ', is a constant derived from a targeted frequency bound (limit) that is reviewed and set, as necessary, by NERC.
- Standard Two - CPS2 — The average ACE for each of the six ten-minute periods during the hour (i.e., for the ten-minute periods ending at 10, 20, 30, 40, 50, and 60 minutes past the hour) must be within specific limits, referred to as L10. [As of August 1, 2006, PJM is participating in the NERC Balancing Standard Proof-Of-Concept Field Test which has established a new metric, Balancing Authority ACE Limit (BAAL), as a possible substitute for CPS-2. Participants in the field test have a waiver from meeting the CPS-2 requirement for the duration of the field test. As a substitute, the field test participants are required to comply with BAAL limits, which have been established on a trial basis.]
- Disturbance Conditions — In addition to CPS1 and CPS2, the Disturbance Control Standard (DCS) as presented in BAL-002-0, "Disturbance Control Performance," is used by each Balancing Area to monitor control performance during recovery from disturbance conditions. The DCS states that ACE must return either to zero or to its pre-disturbance level within fifteen minutes following the start of the disturbance.

Measurements and Compliance – continuous monitoring is performed by PJM's Performance Compliance Department on a daily, monthly, quarterly, and annual basis to ensure compliance with NERC BAL Standards. Performance data measurements are retained in electronic form per NERC BAL requirements.

- ACE Values – The ACE used to determine compliance to the CPS must reflect its actual value and exclude short excursions due to transient telemetering problems or other influences such as control algorithm action.
- System Frequency used to determine compliance to CPS must reflect the actual value used in dispatch provided at full scan rate (minimum 4 second).



- CPS Compliance – Each Balancing Area must achieve CPS1 compliance of 100% and achieve CPS2 compliance of 90%. Dispatchers are provided preliminary CPS2 feedback for situational awareness on a ten minutes basis for their shift information. Daily reports are generated with CPS1 & CPS2 preliminary information for dispatch.
- Performance Standard Surveys – All Balancing Areas must respond to performance standard surveys that are requested by NERC, Survey descriptions are found in Attachment H.
- Disturbance Control Standard Surveys – Each Balancing Area must submit a quarterly summary report to thru the regional authority to NERC documenting the Control Area's compliance to the DCS during the reporting quarter. Details provided in Attachment H reporting requirements for NERC BAL-002
- DCS Compliance – Each Balancing Area must achieve DCS compliance 100% of the time for reportable disturbances.
- Reporting requirements for NERC BAL standards found in Attachment H.
- PJM performs an annual review of measurement parameters and requirement thresholds per NERC and Reliability First Standards.

Whenever the magnitude of ACE indicates a severe shortage of generation, PJM dispatcher notifies PJM Members to immediately supply energy from their Synchronized Reserves. These requests are made via the PJM ALL-CALL communications software and via EMS ICCP datapoints.

3.1.2 PJM Control Implementation

PJM uses the PJM ACE signal to establish the required control signals that are sent to each PJM Member whose generating resources come under the direction of PJM. PJM develops two types of control signals as follows:

- Regulation
- Dispatch

Regulation Signals

PJM calculates ~~two one~~ Regulation signals, as shown by Exhibit 5.

[RegA- low pass filter of ACE for traditional regulating resources](#)

[RegD- high pass filter of ACE for dynamic or fast response resources](#)

Formatted: Indent: First line: 0.5"

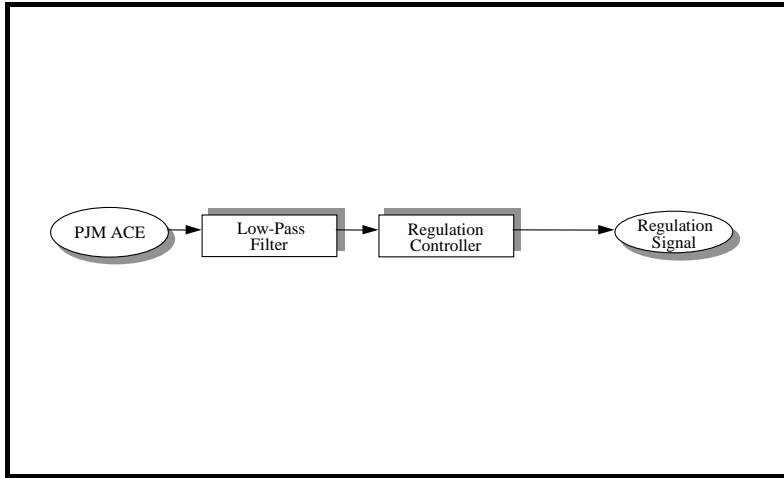

Exhibit 3: PJM Regulation Signals

At present, PJM sends the Regulation signal in the following form to the participating Resource Owners:

- Digital — The Digital Regulation signal is sent to each Resource Owner. The Generation Owners receive this signal and then send the appropriate signal to each regulating resource.

Dispatch Signals

The dispatch signals that are calculated by PJM are intended to direct dispatchable generating resources to “follow” the PJM RTO’s requirement. The strategy that is used by PJM is to first develop a PJM price signal from the raw PJM ACE calculation. Exhibit 6 shows how the Dispatch Rate and MW signals are calculated for each participating Generation Owner.

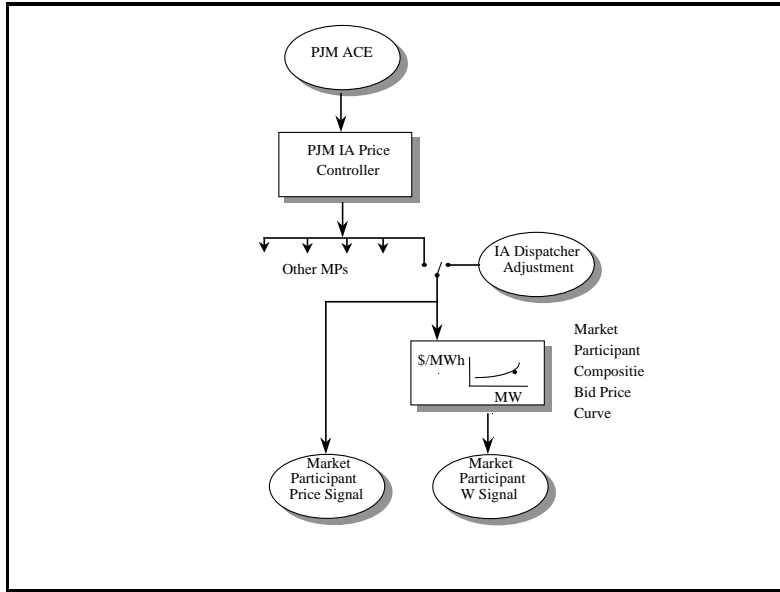

Exhibit 4: Calculation of Dispatch Price and MW Signals

- Step 1 — A common PJM price signal is developed by the RT-SCED tool which acts on load, interchange, transmission constraints and PJM dispatcher input.
- Step 2 — In the event of transmission congestion or other security issues; RT-SCED in conjunction with the PJM dispatcher may recalculate the dispatch price signals for the effected PJM transmission zones. The price signal for a particular PJM Member is then applied to the generation bid prices for that PJM Member.
- Step 3 — The MW versus price relationship is developed by PJM for each participating Generation Owner. The MW versus price relationship is developed by PJM using the scheduled generator offers submitted day-ahead via eMarket. Exhibit 7 shows how the various generation resources are correlated with respect to bid prices in order to develop this total MW versus price relationship.

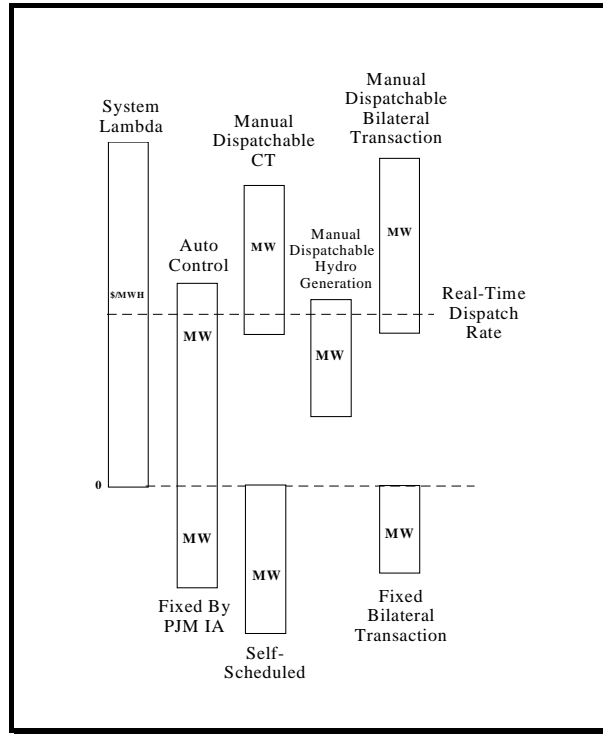

Exhibit 5: Resource Dispatching

It is important to emphasize that the MW versus price relationship applies to manually dispatched, as well as automatically controlled generating units. Since there is a wide mixture of slow and fast responding units and manually dispatched units in the PJM Balancing Area, the Dispatch Rate signal is adjusted slowly by PJM dispatcher in order to avoid unnecessary generation adjustments.

3.1.3 PJM Member Control Implementation

PJM assigns desired control actions to the Internal PJM Members. PJM Members are responsible for the actual physical control of generating resources. This is generally accomplished through Generation Owners. Exhibit 8 shows the information that is exchanged between PJM and the Generation Owners.

Specific requirements regarding telemetered data and controls as required by BAL-005-0, "Automatic Generation Control" are described in ***PJM Manual for Control Center and Data Exchange Requirements*** (M01), "Control Center Requirements," Section 4, [Billing Metering Standards](#).

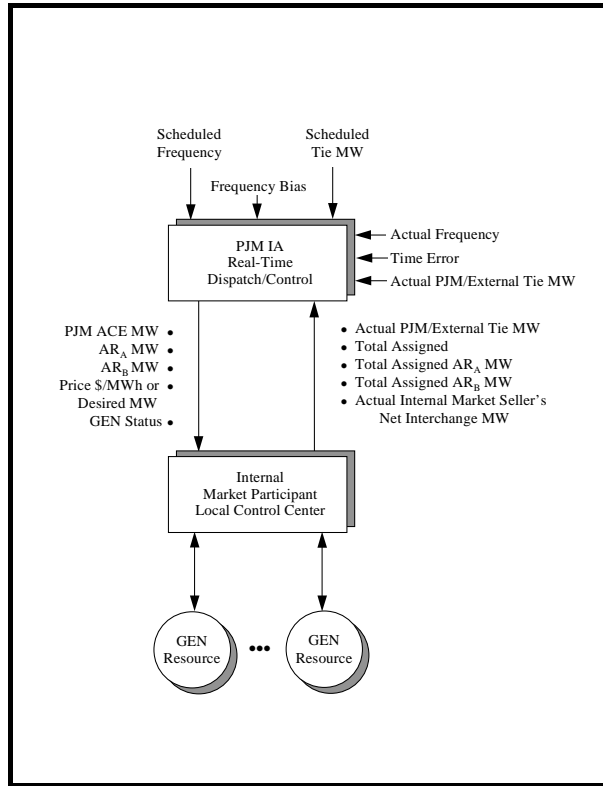

Exhibit 6: PJM Member Interface

The following information is sent by PJM to the Generation Owners:

- PJM ACE MW
- Regulation MW [either RegA or RegD](#)
- Price \$/MWh or desired MW
- Generator status

• The following information is sent by the PJM Members to PJM:

- Actual PJM/external tie line MW
- Actual total generation MW
- Total assigned Regulation MW [either RegA or RegD](#)
- Actual net interchange MW

The PJM Member's Generation Owner converts the total dispatch signal (price or MW) and the regulation signal to individual unit control signals. PJM Member resources that are

Formatted: No bullets or numbering



dispatchable by PJM are expected to respond to the dispatch and regulation signals received from PJM. PJM Members are expected to operate their generating resources as close to desired output levels, as practical, consistent with Good Utility Practice.

3.2 Time Error

The system-wide mismatch between load and generation results in frequency deviations from scheduled frequency. The integrated deviation appears as a departure from correct time, i.e., as a time error. Therefore, time error is the accumulation of frequency deviation over a defined period of time.

In accordance with NERC BAL Standards, each Interconnection designates an Interconnection Monitor to monitor time error and to initiate or terminate corrective action when time error reaches predetermined limits. The PJM RTO is a part of the Eastern Interconnection. The Interconnection Monitor for the Eastern Interconnection is Midwest ISO in Carmel, IN. The Midwest ISO monitors the electric system time against true time, as measured by the National Institute of Standards and Technology (NIST), in Boulder, Colorado. When time error reaches ± 10 seconds, The Midwest ISO initiates a time correction. No time error corrections for fast time will be initiated between 0400 and 1100 hours Central Time. In response to the Interconnection Monitor, PJM implements the requested frequency schedule offset.

A time correction may be halted, terminated, or extended if the designated Interconnection Time Monitor or PJM determines system reliability conditions warrant such action.

After the premature termination of a manual time correction, a slow time correction can be reinstated after the frequency has returned to 60 Hz or above for a period of ten minutes. A fast time correction can be reinitiated after the frequency has returned to 60 Hz or lower for a period of ten minutes. At least 1 hour shall elapse, however, between the termination and re-initiation notices.

3.2.1 Time Error Correction Notification

The Midwest ISO issues the time correction information via a NERC hot-line conference call and a message is posted on the RCIS. A frequency offset of ± 0.02 Hz starts and terminates on the hour or half-hour.

PJM Actions:

- **Step One** - PJM dispatcher notifies the Transmission Owners/Generation Owners, via the PJM ALL-CALL, to announce that time error correction is in effect. To correct for a slow or fast clock, system frequency schedules are offset by ± 0.02 Hz and given an assigned letter designator.
- **Step Two** - At the assigned time, PJM dispatcher inputs frequency schedule into the PJM EMS System using to 59.98 Hz to correct for fast time error or 60.02 Hz to correct for slow time error as directed by the time monitor.
- **Step Three** - When the time error is reduced to specified levels or if the time error is not corrected in a reasonable period, the Midwest ISO issues the order to return frequency schedule setters to 60.00 Hz. The Midwest ISO initiates a NERC hot-line conference call and posts a message on the RCIS. At this time,

PJM dispatcher resets the PJM EMS frequency schedule to 60.00 Hz at the assigned time.

- **Step Four** - PJM dispatcher notifies the Transmission Owners/Generation Owners via the PJM ALL-CALL of the cancellation of the time correction, and the time the scheduled system frequency will return to 60.00 Hz.
- **Step Five** - If reliability concerns develop during the execution of the time error correction, the PJM dispatcher notifies Midwest ISO (St. Paul, MN) and requests that the time error correction be immediately terminated. Similarly, if reliability concerns are anticipated with a scheduled time error correction, the PJM dispatcher notifies Midwest ISO to cancel the scheduled time error correction.

3.3 External Transactions Scheduling

3.3.1 Overview of External Transaction Scheduling

Market participants that wish to transact energy in-to, out-of or through the PJM RTO are required to make their requests to PJM via the NERC E-Tagging software. These requests must be consistent with the more restrictive of either NERC Standard INT-001 (Interchange Transaction Tagging) or the PJM External Transaction Scheduling rules contained within this manual. The NERC E-Tagging software interfaces with PJM's Enhanced Energy Scheduler (EES) software to create an interface that both PJM Market participants as well as PJM Transaction Coordinators can use to evaluate and manage external transactions that affect the PJM RTO.

Based on market participant feedback, PJM has enhanced the EES tool to utilize NERC tags as the source for its external scheduling data. This change was done primarily to ease the amount of data entry required to submit external schedules in PJM as well as conform to general industry trends toward the use of the NERC tag as a schedule. This enhancement aids PJM in handling the increased number of external transactions presented by integration of other control areas in the PJM RTO. Market participants are no longer required to enter schedule data in both the EES system and on a NERC tag as the NERC tag data is utilized by EES as the schedule.

This change highlights an issue of data responsibility because of the nature of E-tagging and the fact that PJM now uses information entered on an E-tag as a schedule. Market participants scheduling in PJM are responsible for ensuring that data on PJM's EES is consistent with that which they desire to be their energy schedule. The continuity of the tagging process dictates that PJM receives its tag data in completed form from its tag authority, as it was entered by market participants. In order to ensure this delivery of data is complete and accurate, the market participants are responsible for confirming the data in PJM's EES to ensure it is consistent with that which they desired for their energy schedule. This confirmation can take place by simply looking at the tag data through the EES user interface, or by viewing customer reports which are made available through EES.

An important aspect of scheduling external transactions in PJM is finding a start and end time to transact energy while respecting the PJM ramp limits imposed for security (see "Ramp Limits" section for additional information on PJM's ramp limits). PJM allows market participants to reserve ramp in advance of completing their transactions via the EES application. This is an optional step in making external transaction requests, as the NERC E-Tag serves as the actual request for scheduling in PJM.



In cases where the NERC E-tag does not have the required fields to request a PJM market specific transaction (e.g. dispatchable, two-settlement etc.) the EES application will be used in concert with the NERC E-tag (see “Entering Dispatchable Schedules” and “Entering Two-settlement transactions” sections).

3.4 External Transaction Scheduling Business Rules

This section will outline the External Transaction Business Rules that are required by PJM. This section will include:

- PJM Contact Information
- External Transaction Timing Requirements
- General Information
- Data Requirements
- Ramp Limits
- OASIS Business Rules
- Entering Ramp Reservations
- Entering Schedules
- Entering Real-Time with Price Schedules
- Entering Two-Settlement Schedules
- Transaction Validations, Verification and Checkout

3.4.1 PJM Contact Information

The following numbers can be used to contact PJM regarding External Energy Transactions:

- Scheduling Fax number – 610-666-4275
- Day-Ahead Scheduling phone number – 610-666-4548, 610-666-8947 and 610-666-8949
- Hourly Scheduling phone number – 610-666-4510
- EES Hotline (used to report issues, or to ask questions during normal business hours) – 610-666-2270
- PJM Helpdesk (used to report technical issues during non-business hours) – 610-666-8886

3.4.2 External Transaction Timing Requirements

The following timing requirements are imposed by PJM for the submission of ramp reservations:

- Ramp reservations can be made up to 30 minutes prior to the scheduled start time for hourly transactions.
- Ramp reservations can be made up to 4 hours prior to start time for transactions that are more than 24 hours in duration.

- Ramp reservations utilizing the Real-Time with Price option must be made prior to 1200 noon (EPT) one day prior to start time.

Ramp reservations expire if they are not used. The following timing requirements are imposed on ramp reservations that are not scheduled against:

- For ramp reservations less than or equal to 24 hours in duration:
 - If the reservation is submitted 1 hour prior to the start of the schedule or less, the reservation will be held in Pending Tag status for 10 minutes.
 - If the reservation is submitted more than 1 hour, but less than 4 hours prior to the start of the schedule, the reservation will be held in Pending Tag status for 15 minutes.
 - Reservations that are less than 24 hours in duration and submitted 4 or more hours prior to the start of the schedule will be held in Pending Tag status for 90 minutes.
 - Reservations made on a day-ahead basis will expire at 1430 EPT, one day prior to the start of the schedule. Note that a ramp reservation will not be “split” into separate days, so if a ramp reservation is made for multiple days, and not scheduled against, and if the start time for the multi-day reservation is the next day, the entire reservation will expire.

Ramp reservations that have been placed In-Queue will expire if sufficient ramp room does not become available. The following timing requirements are imposed on ramp reservations that have been placed In-Queue:

- Reservations that are 24 hours or less in duration will be held in In-Queue status until 30 minutes prior to the start of the schedule.
- Reservations that are greater than 24 hours in duration will be held in In-Queue status until 5 hours prior to the start of the schedule.

The following timing requirements are imposed by PJM for the submission of Schedules. Schedules are submitted to PJM by submitting a valid NERC Tag. (The schedule is considered submitted when the NERC Tag is received by the PJM Tag Approval Service, not when it is submitted by the market participant’s Tag Agent software):

- Schedules can be submitted up to 20 minutes prior to the scheduled start time for hourly transactions.
- Schedules can be submitted up to 4 hours prior to the scheduled start time for transactions that are more than 24 hours in duration.
- For a schedule to be included in PJM’s Day-Ahead checkout process, they must be implemented by 1400 (EPT) one day prior to start of schedule.
- Schedules utilizing the Real-Time with Price option must be submitted prior to 1200 noon (EPT) day prior to start time.
- Schedules utilizing FIRM Point-To-Point transmission service must be submitted by 1000 (EPT) one day prior to start of schedule. Transactions submitted after 1000 (EPT) one day prior will be accommodated if practicable.



The following timing requirements are imposed by PJM for the submission of Two-Settlement Transactions:

- All Two-Settlement transactions must be submitted by 1200 noon (EPT) one day prior to start time.

3.4.3 General Information

- External offers can be made either on the basis of an individual generator (resource specific offer) or an aggregate of generation supply (aggregate offer).
- PJM will only accept the transaction if submitted by a member company.
- Transmission reservations that are not used due to canceled spot market offers will be subject to transmission charges as appropriate.
- PJM does not accept bids where the PJM Interchange Market is identified as both the source (GCA) and sink (LCA).
- PJM does not accept offers for resources committed to supply operating reserves to another Balancing area. PJM does not double count resources internal to PJM for operating reserves. If energy is being offered from a resource to PJM and is already included in the PJM operating reserves, the energy can be accepted, but does not participate in PJM operating reserves accounting.
- Offers not properly submitted are rejected. The PJM member is notified of the reason for rejection and the PJM member may then take action to submit a new offer.

3.4.4 Data Requirements

Market participants are expected to keep PJM informed of all external transactions that involve the operation of the PJM RTO. The following information is submitted to PJM via the market participants E-Tag agent service and/or EES:

- Valid NERC E-Tag
- Valid transaction path
- Start date before end date
- Start and end times in the future
- Requested MW profile
- Valid transmission (see "OASIS Business Rules" for more information)
- Price associated with transaction (if utilizing the Real-Time with Price option)

3.4.5 Ramp Limits

PJM validates all external transaction requests against a net interchange ramp. The ramp limit is configurable by PJM dispatch based on operating conditions. There are two separate ramps that are evaluated, a PJM Net Interchange Ramp, and a NYISO Interchange Ramp.

- PJM Variable Ramp

- At no time, can the difference in the net interchange be greater than the ramp designated by the PJM dispatch at any given 15 -minute interval. Ramp room is allocated on a first come, first serve basis. Refer to Exhibit 17 for a ramp example to see how the ramp is calculated for any given 15 - minute interval.
- NYISO 1000 MW Ramp
- PJM also monitors a ± 1000 MW ramp with the NY ISO. At no time can the difference in the interchange between NY and PJM be greater than ± 1000 MW at any 15-minute interval. Ramp room for NY transactions is allocated on a first come, first serve basis. NY transactions submitted to PJM will be evaluated against both the PJM ramp and the NY ISO ramp.

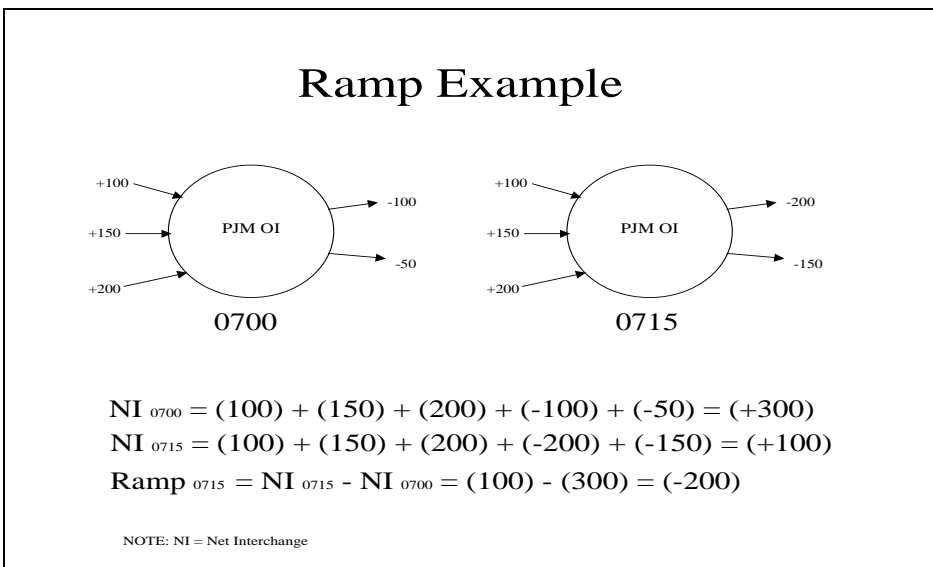

Exhibit 7: Example Ramp Calculation

3.4.6 OASIS Business Rules

All external transaction requests require a CONFIRMED transmission reservation from the PJM OASIS. PJM offers several transmission product types, such as hourly, daily, weekly, monthly, yearly, on and off-peak, non-firm, firm and network transmission. PJM also offers the opportunity to state whether or not the market participant is willing to pay congestion. These, and additional options, are further explained in the “PJM Regional Practices” document, which can be found on the PJM OASIS home page at <http://oasis.pjm.com>.

On some occasions, due to PJM ramp rules, market participants are required to shift their energy requests. If the market participant shifts their energy up to one hour in either direction, they are not required to purchase additional transmission. Likewise, if the market participant chooses to fix their ramp violation by extending the duration of the transaction, they do not have to purchase additional transmission if the total MWh capacity of the

transmission request is not exceeded. For graphical representations of these scenarios, refer to Exhibit 9 through Exhibit 12.

On-Peak Monday-Friday

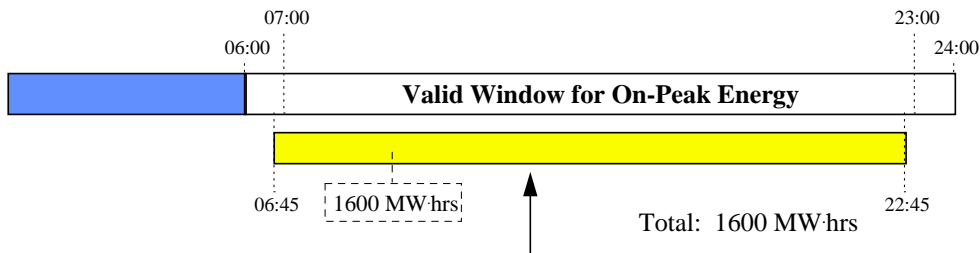

Example of Valid Energy Schedule using a 100MW Capacity
On-Peak Transmission Service Reservation
Over 16 Hour Period

Exhibit 8: On-Peak Transmission Service Over 16 Hour Period Example

On-Peak Monday-Friday

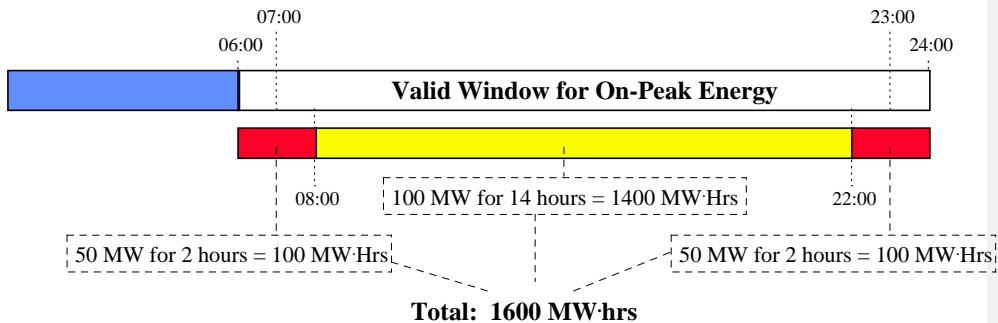

Example of Valid Energy Schedule using a 100MW Capacity
On-Peak Transmission Service Reservation
Over 18 Hour Period

Exhibit 9: On-Peak Transmission Service Over 18 Hour Period Example

Off-Peak Monday-Friday

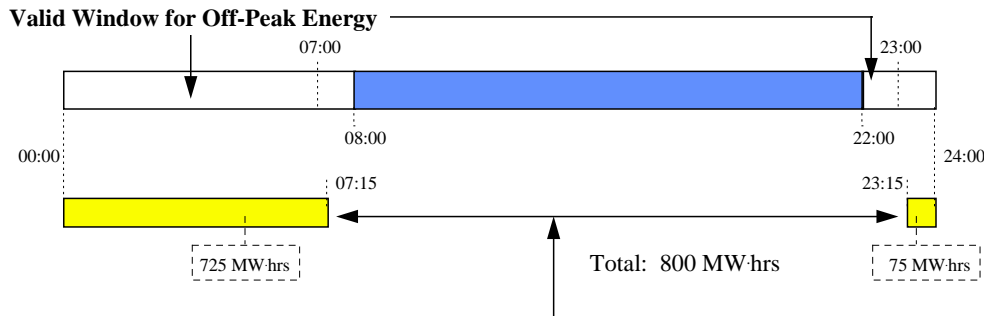

Example of Valid Energy Schedule using a 100MW Capacity
Off-Peak Transmission Service Reservation

Exhibit 10: Off-Peak Monday-Friday Transmission Service Example

Off-Peak Saturday & Sunday

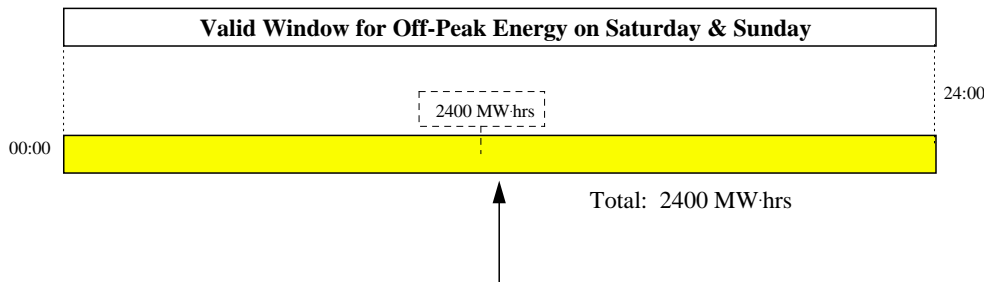

Example of Valid Energy Schedule using a 100MW Capacity
Off-Peak Transmission Service Reservation

Exhibit 11: Off-Peak Saturday-Sunday Transmission Service Example

Frequently Asked Questions (regarding on-peak and off-peak energy scheduling):

(Q1) A market participant has reserved off-peak daily transmission for Wednesday, but ramp room is not available at 07:00 or 23:00.

(A1) Two possible solutions are 1) the energy may be scheduled from 00:00 to 08:00 or 2) the energy may be scheduled from 00:00 to 07:15 and from 23:15 to 24:00.

(Q2) A market participant has reserved on-peak weekly transmission. Ramp room is available from 07:00 to 23:00 Tuesday through Friday, but ramp room is not available at 07:00 or 23:00 on Monday.

(A2) The energy may be scheduled 07:00 to 23:00 Tuesday through Friday. One solution to the Monday ramp limit is to schedule the energy from 06:45 to 22:45.

3.4.7 Entering Ramp Reservations

Each PJM Member Company that is authorized to do business in PJM's energy market is given an EES account. It is in the EES application that ramp reservations are made.

Ramp reservations are an optional step in scheduling transactions in PJM. A ramp reservation can be made to "hold" ramp room while market participants complete their scheduling responsibilities. Ramp reservations are then associated on the NERC Tag when the market participant wishes to submit the schedule. The ramp reservation is validated against the submitted NERC Tag to ensure the energy profile and path matches. Ramp reservations are generally used to ensure the ability to schedule prior to purchasing transmission or making other potentially cost affecting decisions.

To make a ramp reservation, the market participant enters the EES application, and navigates to the "Ramp Reservation" screen. On this screen, the market participant enters the path for which they are interested in transacting energy, their energy profile and any other unique information that may apply to a schedule (i.e. special exceptions, notes, outside ID's, internal naming conventions etc.). Upon submission of a ramp reservation, PJM validates the information against ramp availability. If it passes the current ramp limits, the ramp reservation will pass, and will move into a status of "pending tag". At this point, the market participant is holding a valid reservation that can then be associated on a NERC Tag for scheduling.

3.4.8 Entering Schedules

Market participants enter schedules in PJM by submitting a valid NERC Tag. As noted in the previous section, if the market participant holds a ramp reservation in the status of "Pending Tag", they can associate the ramp reservation on the NERC Tag. This is done by placing the ramp reservation in the "miscellaneous" column on the PJM Transmission Provider line, of the "physical segment" portion of the NERC Tag.

If no ramp reservation was made prior to scheduling, a NERC Tag can be submitted without a reservation. NERC Tags that are submitted without a ramp reservation will automatically have a ramp reservation created that matches the energy profile and path of the NERC Tag. This newly created reservation will be evaluated against ramp, and an approval or denial will be made based on the validation. If there is enough ramp room, PJM will continue with other validations (See "Transaction Verification and Checkout"). If all validations pass, an approval



message will be sent to the NERC Tag, and upon IMPLEMENTATION of the NERC Tag, the transaction will be scheduled by PJM.

Because of the nature of NERC tagging, it is possible for the market participant who enters a NERC tag to not be consistent with the market participants listed for each TP segment on a particular tag. In this instance, the financially responsible party (FRP) entering the tag is effectively acting on behalf of other market participants that are listed. Because PJM will now be identifying a NERC tag as a market participant's schedule, it will be necessary for those market participants who have had a tag entered on their behalf to acknowledge this tag through the EES.

3.4.9 Entering Real-Time with Price Schedules

Real-Time with Price schedules differ from other schedules in that an action **must** be made in EES in addition to the submission of a NERC Tag. To enter a Real-Time with Price schedule, the market participant must first make a ramp reservation in EES using the "Real-Time with Price" tab in the notebook section of the ramp reservation screen. In addition to the information entered for a Real-Time schedule, market participants are also required to enter a price associated with each energy block. Upon submission, the Real-Time with Price request will automatically move to the "Pending Tag" status, as Real-Time with Price schedules do not hold ramp.

Once the information is entered in EES, a NERC Tag must be submitted with the ramp reservation associated on the NERC Tag. This is done by placing the ramp reservation in the "miscellaneous" column on the PJM Transmission Provider line, of the "physical segment" portion of the NERC Tag. For Real-Time with Price schedules, the NERC Tag energy profile must match exactly for the tag to be approved.

3.4.10 Entering Two-Settlement Schedules

Market participants can submit Two-Settlement schedules to the eMarket application through EES. These schedules do not require a NERC tag, as they are only financial obligations, and are not considered physical schedules for actual flow. Two-Settlement schedules are submitted using the "Two-Settlement" tab in the notepad section of the ramp reservation screen.

Two-Settlement schedules require an OASIS number to be associated upon submission. The path is identified on the OASIS reservation.

In addition to the selection of OASIS and pricing points, the market participant must enter their energy profile. The option to choose fixed, dispatchable and up-to are also displayed in the notepad section. The type "fixed" acts as a price taker, "dispatchable" sets a floor or ceiling price criteria for acceptance and "up-to" sets the maximum amount of congestion the market participant is willing to pay for acceptance in the Two-Settlement Market. Graphing energy is done the same way as a Real-Time or Real-Time with Price request.

3.4.11 Transaction Validations, Verification and Checkout

Transactions must pass specific validations and evaluations prior to being scheduled. The following validations and evaluation and checkout procedures are done to ensure accurate information and reliable scheduling in PJM.

- Validations

On submission, the following validations are performed on ramp reservations:

- Path Identified
- Stop time after start time
- Energy Profile Identified
- Price associated with Energy Profile (only applicable for Real-Time with Price)
- Ramp Availability (not applicable for Real-Time with Price)
- Timing Requirements are met for submission deadlines

On submission, the following validations are performed on NERC Tags:

- Syntax validation (See NERC Tagging Policy for complete list of syntax validations for NERC Tags)
- Path on NERC Tag matches ramp reservation (if identified) and OASIS path
- Timing requirements are met for submission deadlines
- PJM Loss type must be financial (FIN)
- Ramp availability (if no ramp reservation is identified)
- OASIS validation for valid OASIS, valid path, instantaneous capacity, total capacity, date-time, priority and vertical stacking (not allowed)
- Token and Value fields (in miscellaneous column) have valid inputs
- FRP check

On submission, the following validations are performed for two settlement requests:

- Path identified
- Timing requirements are met for submission deadlines
- OASIS validation for valid OASIS, ensure that the reservation is willing to pay congestion, OASIS is valid for period covered by the two-settlement contract and capacity checks
- Pricing point(s) have been identified
- Stop time is after start time
- Energy profile is identified
- Price is associated for energy profile (for dispatchable option only)
- Congestion amount is identified for energy profile (for up-to congestion option only)
- Real-Time Evaluation and Checkout

If all validations pass on a Real-Time schedule, PJM will approve the tag. Once the tag is approved by all parties associated on the tag and the status of the tag becomes "IMPLEMENTED", the schedule will be ready for the Balancing Area to Balancing Area Checkout. If during the Balancing Area to Balancing Area

checkout, both parties agree to the interchange on the NERC Tag, the schedule will flow.

- Real-Time with Price Evaluation and Checkout

Real-Time with Price schedules are verified differently than Real-Time schedules. Real-Time with Price schedules are evaluated hourly to determine if they will be loaded or not for the upcoming hour. This evaluation is done by the PJM Generation Dispatcher. If the dispatcher feels that the economics for the schedule warrant the transaction to be loaded or unloaded, they will inform the transaction coordinator to load or unload the contract. This evaluation is based on a very conservative approach, and works similar to the way the generation dispatcher would call on or off generation. In addition to the economics of the transaction, the generation dispatcher may also take into consideration the ramp availability for the loading or unloading of the schedule. Since Real-Time with Price schedules do not hold ramp room, there may be times where the economics warrant a schedule to be loaded, but due to security issues related to ramp, the schedule will not be called on to flow. Once a Real-Time with Price schedule has been called on to flow, a reload request will be issued by the PJM Transaction Coordinator. If all external parties approve the reload request, and it passes the Balancing Area to Balancing Area checkout process, the schedule will flow.

- Two-Settlement Evaluation and Checkout

For Two-Settlement scheduling, EES serves only as an interface to the eMarket application. Two-Settlement transactions are evaluated by the PJM Markets Department, and the results are fed back to EES to allow market participants to view the results. There is no Checkout performed on two-settlement schedules, as they are considered financially binding transactions, not physical schedules.

3.5 Inadvertent Interchange

Hourly inadvertent interchange is defined as the difference between hourly net actual interchange and hourly net scheduled interchange of a Balancing area. Attachment H provides additional detail regarding BAL standard reporting requirements. It is caused by any of the following factors:

- bias response to frequency deviations occurring on the interconnected system
- metering errors (methods of correction details are discussed in *PJM Manual for Operating Agreement Accounting* (M28), Section 11, "Meeting Reconciliation Accounting").
- inability of system generation to exactly match load and/or net interchange schedule changes

Hourly inadvertent interchange may accumulate in a balancing area as a megawatt-hour credit or debit. It is accounted for each month. PJM maintains a record of the PJM RTO's accumulated inadvertent interchange for both On- and Off-Peak Periods as required by the NERC BAL standards.

- Off-Peak Period is from 2300 to 0659, Monday thru Saturday, and all day Sundays and Holidays
- On-Peak Period is from 0700 to 2259, Monday thru Saturday



Over time, PJM attempts to minimize the amount of accumulated inadvertent interchange. This is accomplished by continually monitoring and correcting for inadvertent interchange. The portion of inadvertent interchange caused by frequency bias is self-compensating if no additional action is taken by PJM dispatcher. This is because on the average, frequency deviations are low as often as they are high. In order for time error to average zero, the inadvertent interchange that flows as the result of frequency bias contribution is balanced automatically by the tie-line bias control.

3.5.1 Correcting for Accumulation of Inadvertent Interchange

It is the responsibility of PJM dispatcher to correct for the accumulation of inadvertent interchange.

PJM Actions:

The reduction of an accumulation (on an On-Peak Period or Off-Peak Period basis as defined above) of inadvertent interchange is accomplished by one of the following two methods:

- **Unilateral Payback** —Unilateral Payback can only occur when the reduction of the accumulation of inadvertent is in a direction that serves to decrease the time error. An accumulation of undergeneration can only be paid back (requiring the PJM Balancing area to overgenerate) when time error is less than zero (i.e., slow). Payback of an accumulation of overgeneration (requiring the PJM RTO to undergenerate) requires a time error greater than zero (i.e., fast).

The maximum allowed payback per hour is 20% of the PJM RTO's current frequency bias setting. The PJM RTO's frequency bias setting is calculated by PJM and approved by NERC. The maximum payback occurs when the absolute value of time error is one second or more and meets the time error direction criteria described above. When the absolute value of time error is less than one second (and meets the time error direction criteria), payback is scaled down proportionally to the time error (e.g., if time error is 0.5 seconds, payback is 10% of the frequency bias setting).

- **Bilateral Payback** — Bilateral Payback is scheduled with another Balancing area and is accomplished as follows:
- Inadvertent interchange accumulation may be reduced by scheduling a correction with any adjacent balancing area, provided they have an accumulation in the opposite direction. The amount of schedule established by PJM dispatcher is determined by the following factors:
 - Amount of Accumulated inadvertent interchange
 - Current net interchange schedule in effect
 - Current state of the PJM Balancing area with respect to load and transmission facilities

If a schedule cannot be established with the adjacent balancing area, correction of inadvertent interchange accumulations may be scheduled with a remote Balancing area, provided that the intervening Balancing area dispatchers are advised of such schedules and are agreeable.



There may be times when the adjacent balancing area desires to establish a schedule to reduce inadvertent interchange accumulations with Balancing areas other than the PJM RTO.

3.5.2 Measurements and Compliance

In accordance with NERC INT Standards, PJM will coordinate interchange transactions per the respective established Operating Agreements.

PJM Members Actions:

None



Section 4: Providing Ancillary Services

Welcome to the *Providing Ancillary Services* section of the **PJM Manual for Balancing Operations**. In this section you will find the following information:

- How PJM monitors and restores reserves (see “Reserves”).
- How PJM determines and assigns Regulation (see “Regulation”).
- How a generating resource is tested and qualified for Regulation service (see “Qualifying Regulating Resources”).
- How PJM ensures and monitors Black Start Service (see “Black Start Service”).

4.1 Reserves

Reserves are the additional capacity above the expected load. Scheduling excess capacity protects the power system against the uncertain occurrence of future operating events, including the loss of capacity or load forecasting errors.

4.1.1 Monitoring Reserves

PJM is responsible for monitoring and adjusting the reserves to ensure compliance with NERC, SERC, and RFC BAL standards for the PJM Balancing Area. On a daily basis the PJM dispatcher performs an Instantaneous Reserve Check (IRC) prior to each peak or more often as system conditions require to determine if adequate reserves exist to meet the PJM Reserve Requirements. An IRC may be taken more frequently if system conditions dictate. When the PJM Generation dispatcher requests an IRC, member dispatchers report the information via eDART. If eDART is unavailable, member dispatchers report the information directly to the PJM Generation dispatcher. Attachment A presents and describes the PJM IRC report.

An IRC provides PJM dispatcher with an indication of the actual reserves that are available at that point in time. By conducting an IRC at strategic points during the day, PJM dispatcher establishes benchmarks between which the actual reserve can be estimated. Since system conditions can change very rapidly, the IRC is only an indication of the actual reported reserves at that point in time. PJM dispatcher uses the results of the IRC to determine if reserve shortages exist and what, if any, Emergency procedures should be declared to supplement the electronic reporting of reserves through the EMS systems.

When the PJM Net Tie Deviation indicates undergeneration, the Synchronized Reserve total is adjusted downward by the amount of the Net Tie Deviation to reflect the PJM Balancing area’s generation deficiency. Conversely, when the PJM Net Tie Deviation indicates overgeneration, the Synchronized Reserve total is adjusted upward by the amount of the Net Tie Deviation to reflect the PJM Balancing area’s generation excess. Therefore, when possible PJM dispatcher requests an IRC when the ACE and Net Tie Deviation is close to zero MW.

PJM Actions:

- **Step One** - Using the PJM ALL-CALL, PJM dispatcher requests an IRC.
- **Step Two** - Upon receipt of all Generation Owner reports, PJM dispatcher determines the following values:



- PJM Operating Reserve
- Adjusted Primary Reserve versus Primary Reserve Requirement.
- Adjusted Synchronized Reserve versus Synchronized Reserve Requirement.
- Unaccounted for capacity
- Area Synchronized Reserve levels
- **Step Three** - PJM dispatcher compares the values calculated in Step (2) to the corresponding objectives and then determines whether reserve deficiencies exist.
- **Step Four** - Using the PJM eDART, PJM dispatcher reports the results of the IRC to the Generation Owners/Transmission Owners.

PJM Member Actions:

- **Step One** - The Generation Owner dispatchers promptly report the following values to PJM via eDART. If eDART is unavailable, the values are reported directly to PJM dispatcher via telephone:
 - Normal Regulating Reserve
 - **Synchronous** Reserve Non-Regulating
 - **Synchronous** Reserve Regulating
 - Quick Start Reserves
 - Supplemental (formerly secondary) Reserve
 - Operating Reserve
 - Scheduled capability that is more that 30 minutes away
 - Capacity reductions that are not known to PJM dispatcher

See [Attachment A](#) for reserve calculations and IRC reporting requirements.

4.1.2 Loading Reserves

During disturbance conditions (i.e., loss of generation and/or transmission resources), synchronized reserve and, to the extent necessary, Non-Synchronized Reserves are used to recover the ACE so that tie line schedules are maintained. Depending on system conditions, the manual methods may be used to accomplish this recovery. Based on system conditions and the ability of regulation to recover, PJM operators will evaluate the need to implement its Contingency Reserve upon the contingent loss of generation equal to 80% or more of its most severe single contingency.

- **Manual Method** — Includes raising the Lambda signal manually and committing additional equipment.



PJM Actions:

- PJM dispatcher determines the approximate amount and location of lost generation, and the amount of Synchronized Reserve that must be loaded to:
 - Correct for the sudden loss of generation located within the PJM Balancing area (as indicated by the PJM Balancing area's ACE and system frequency deviations)
 - Return interchange transfers or other thermal or reactive limitations to within the appropriate limits
 - Implement 100% synchronized reserves and /or contingency reserves (quick start) if the unit loss > 80% of the largest unit contingency and there is insufficient regulation and economic generation to recover the ACE within DCS (BAL standards).
- PJM dispatcher requests the Resource Owner, via the PJM ALL-CALL, to load a percentage (25%, 50%, 75%, or 100%) of the Synchronized Reserve (typically 100%) in the appropriate control zone(s). PJM has several Synchronized Reserve market areas. The dispatchers will select the most effective response respecting the requirements of the regional reserve sharing programs in which PJM is a participant.
- If specific equipment is excluded from the request, PJM dispatcher calls the appropriate Resource Owner immediately following the PJM ALL-CALL message.
- If transmission limits exist or may be caused by loading Synchronized Reserve and Non-Synchronized Reserve in certain geographic areas or control zones, PJM dispatcher specifies the areas or control zones that are to be included in the request for Synchronized Reserve.
- If PJM dispatcher anticipates that loading of Synchronized Reserve may continue for longer than ten minutes, PJM dispatcher includes this statement in the PJM ALL-CALL message.
- PJM Dispatcher contacts external systems to implement Shared Reserves (as required).
- PJM dispatcher also requests the loading of an appropriate amount of non-synchronized reserve (as required).
- If PJM dispatcher determines that the Synchronized Reserve that is being loaded is not sufficient to recover the system from a facility malfunction or failure, PJM dispatcher requests synchronized Supplemental Reserve to be loaded (as required).
- As the Resource Owner dispatchers load the reserves, PJM dispatcher evaluates the effect. PJM dispatcher surveys the resources loaded and determines generation that is needed to remain loaded and the replacement resources that can be returned to normal status so that the PJM Balancing area load can be economically carried at a new price level.
- PJM dispatcher cancels the requests, as appropriate.



PJM Members Actions:

- The resource owners, without regard to price and as quickly as possible, load the requested percentage of Synchronized Reserve and Non-Synchronized Reserve. PJM Members continue to load resources until directed by PJM dispatcher to discontinue.
- Upon cancellation, the generation owner dispatchers unload the Synchronized and Non-Synchronized Reserve, as directed by PJM dispatcher.

4.2 Shared Reserves

Shared Reserve Activation is a procedure between the Northeast Power Coordinating Council (NPCC) and the PJM Mid-Atlantic Control Zone (former MAAC region member companies) to jointly activate a portion of their ten-minute reserve following any of the following situations:

- Generation or energy purchase contingencies equal to or greater than 500 MW (300 MW for Maritimes) occur under conditions where activation assists in reducing a sustained load/generation mismatch
- Two or more resource losses below 500 MW (300 MW for Maritimes) within 1 hour of each other.
- Periods of significant mismatch of load and generation

The participating systems in NPCC shared reserves are the ISO New England (ISO NE), the New York Independent System Operator (NYISO), PJM East Control Zone, Maritimes, New Brunswick and Independent Electricity Market Operator (IESO formerly IMO of Ontario). The objective is to provide faster relief of the initial stress on the interconnected transmission system. The NPCC Operating Reserve Policy and the Operating Reserve Policies of all NPCC areas and of the PJM Mid-Atlantic Control Zone are not changed by any of the provisions of this plan.

The NYISO acts as the plan coordinator.

PJM Actions:

If the loss of generation/purchase is located in the NPCC:

- The NYISO supervising dispatcher assigns the PJM Mid-Atlantic Control Zone a share of reserve pick-up. NYISO indicates the amount of participation.
- PJM dispatcher manually adjusts regulation, loads generation, or Synchronized Reserve in selected areas or across the entire PJM Mid-Atlantic Control Zone based on transfer limitations. This assistance is implemented at a zero time ramp rate immediately following allocation notification. Response by assisting balancing areas shall respond as quickly as possible, assuming the same obligation as if the contingency occurred within the balancing area. This should be implemented via manually adjusting regulation if possible.
- PJM dispatcher notifies the NYISO supervising dispatcher that PJM Mid-Atlantic Control Zone's reserve pick-up is completed.
- When the contingent system satisfies its ACE requirements, they notify the NYISO supervising dispatcher, who requests all participants to cancel their



shared reserve allocations (normally ten minutes, but no longer than 30 minutes) when the generator loss is replaced. The assistance provided by the PJM Mid-Atlantic Control Zone is ramped out at a ten-minute ramp rate.

- When the PJM Mid-Atlantic Control Zone completes its reserve pick-up, PJM dispatcher notifies the Local Control Centers to cancel Synchronized Reserve loading.

If the loss of generation/purchase is located in the PJM Mid-Atlantic Control Zone:

- PJM dispatcher activates 100% Synchronized Reserves and notifies the NYISO supervising dispatcher of generation loss, and includes any special requests. For example, for the loss of a large eastern unit, PJM dispatcher may request IMO not to participate.
- The NYISO supervising dispatcher activates shared reserves and notifies PJM dispatcher, via conference call, of the ten-minute reserve amount that NPCC members contribute.
- PJM dispatcher terminates shared reserves (normally ten minutes, but no longer than 30 minutes) when the generation loss is replaced.

4.2.1 Payback

Currently, payback mwhs are not required for NPCC Shared Reserve Events.

PJM Member Actions:

None.

4.2.2 Restoring Reserves

By continuously monitoring reserves, PJM dispatcher ensures that reserve levels are maintained in accordance with NERC BAL Standards. During normal operation, PJM dispatcher loads the system based on economy while monitoring the available reserves. If, however, based on the best judgment of PJM dispatcher after evaluating the results of the IRC, reserve deficiencies exist on the system, the following actions are taken, dependent on the deficiency:

- Synchronized Reserve Deficiency — Normally, restoration of Synchronized Reserve is accomplished by condensing CTs, notifying interruptible load resources, or loading Non-Synchronized Reserve or Supplemental Reserve to a minimum level to provide sufficient Synchronized Reserve or to the economic energy level to allow equipment (i.e., steam units) to back down to provide sufficient Synchronized Reserve.
- Primary Reserve Deficiency — When PJM dispatcher is assured that the Synchronized Reserve objective is covered, PJM dispatcher attempts to eliminate any Primary Reserve deficiency. Restoration is accomplished by any combination of the following actions:
 - Loading Supplemental Reserve to Primary Reserve status or providing additional Primary Reserve on other equipment.



- Bringing additional equipment which is available but not scheduled to operate into the Primary Reserve status.

That portion of the Primary Reserve deficiency that is due to an adjustment to the internal PJM Primary Reserve as a result of a net non-capacity interchange scheduled into PJM can be tolerated provided system reliability is not degraded. On these occasions, PJM dispatcher ensures that sufficient shutdown CT and/or hydro capability are readily available to cover the amount of the deficiency.

- Operating Reserve Deficiency — When PJM dispatcher is assured that both the Synchronized and Primary Reserve objectives are covered, PJM dispatcher attempts to eliminate any deficiency in Operating Reserve. Sufficient reserve is maintained for coverage of load-forecast uncertainty and probable additional failure or malfunction of generating equipment. The decision of whether to replenish Operating Reserve is based on PJM dispatcher's best judgment. PJM dispatcher may choose to replenish all, some, or none of the Operating Reserve during the operating day.

4.3 VACAR Reserve Sharing

PJM, on behalf of Dominion-Virginia Power, participates in the VACAR reserve sharing group, which consists of Dominion-Virginia Power, Duke Power, South Carolina Electric and Gas, Progress Energy-Carolinas, and South Carolina Public Service Authority. The purpose of the agreement is to share reserves to enhance reliability and to decrease the cost of maintaining reserves for each system.

Upon the telephone request of a member, the responding member will provide reserve energy for a period of up to 12 hours to support the needs of the requesting member.

PJM Actions:

Respond to requests for assistance due to a contingency event, as requested by another member, by scheduling delivery of VACAR reserve energy to the requesting member for delivery at the border between PJM and the CPL balancing area.

Request the scheduling of VACAR reserve energy from other VACAR members if needed. Energy will be received at the CPL balancing area border with PJM.

Dominion-Virginia Power Actions:

Performs billing and provide compensation, as applicable, for reserve energy received by PJM called for on behalf of Dominion or provided by PJM on behalf of Dominion to another VACAR member.

4.4 Regulation

The PJM RTO is a single Balancing Area consisting of multiple Control Zones. Regulation for each Control Zone is supplied from resources that are located within that zone. Resource owners providing Regulation are required to comply with standards and requirements of Regulation capability and dispatch, as described in this section.



4.4.1 PJM RTO Regulation Market Obligations

The Regulation Requirement for the PJM RTO can be found in [Manual 13, § section 4.4.3 Determining Regulation Assignment of this manual](#)~~section 2~~. The resources assigned to meet this requirement must be capable of responding to the AR signal immediately, achieve their bid capability within five minutes and must increase or decrease their outputs at the ramping rates that are specified in the data that is submitted to PJM.

The PJM RTO requires that the Regulation range of a resource is at least twice the amount of Regulation assigned. A resource capable of automatic energy dispatch that is also providing Regulation reduces its energy dispatch range by the regulation assigned to the resource. This redefines the energy dispatch range of that resource. (The resource's assigned regulation subtracted from its regulation maximum forms the upper limit of the new dispatch range, while the resource's regulation minimum plus its assigned regulation forms the lower limit of the new dispatch range.) Exhibit [123](#) illustrates the limit relationship.

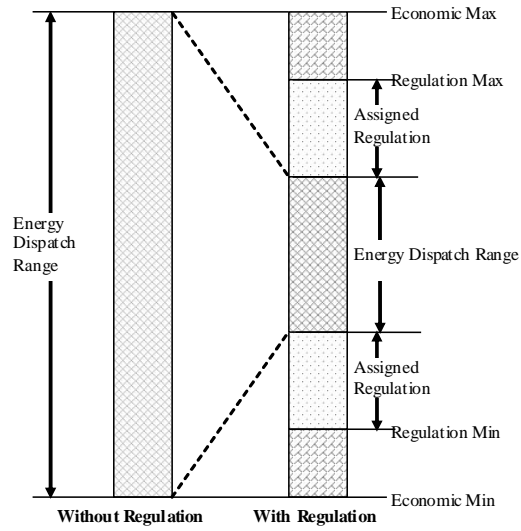

Exhibit 12: Limit Relationship for Regulation



Resource owners wishing to provide Regulation in the PJM balancing area are required to submit the following data via eMKT no later than 6:00 p.m. day-ahead:

- Offer MW – The maximum MW amount of regulation that the resource is willing to provide for the next day. This value is limited by the resource's qualified capability. Offer MW may be adjusted hourly throughout the operating day giving 60 minutes notice before the operating hour.
- Offer Price – The price in ~~\$/MWH~~ at which the owner is willing to provide Regulation from the associated resource. [The price should reflect the capability of the resource in \\$/MW and the performance of the resource in \\$/ΔMW of the resource.](#) This value cannot be changed after 6:00pm day-ahead.
- Available Status – Indication of whether the resource is available, unavailable or self-scheduled for Regulation. Available Status may be adjusted hourly throughout the operating day giving 60 minutes notice before the operating hour.
- Regulation Max MW – The maximum MW value the resource can attain while providing Regulation. Regulation Max MW may be adjusted hourly throughout the operating day giving 60 minutes notice before the operating hour.
- Regulation Min MW – The minimum MW value the resource can attain while providing Regulation. Regulation Min MW may be adjusted hourly throughout the operating day giving 60 minutes notice before the operating hour.
- Min MW – The minimum amount of regulation the resource is physically capable of providing for an hour. This number must be less than or equal to the Offer MW. This value cannot be changed after 6:00pm day-ahead.

4.4.2 Regulation Signals

Resource owners will receive from PJM:

- ~~AReg~~—Assigned Regulation ([ARegA or ARegD](#)). This is the assigned hourly regulation quantity (MW) that is cleared from the regulation market system. It is assigned for each individual resource that is qualified to regulate in the PJM market. This value, although typically static for the hour, will be sent on a 10 second scan rate. [Resources will receive a separate assignment for RegA and RegD if they have resources that are dual qualified but will be assigned to follow only one signal for the hour.](#)
- [Regulation Control Signals \(RegA, RegD\)](#) ~~RegA~~ – Real-time instantaneous resource owner fleet regulation signal (+/- MW). This signal is used to move regulating resources in the owner's fleet within the fleet capability (+/- TReg). This value will be sent on a 2 second scan rate.
 - [RegA-is the low filter ACE signal sent to traditional regulating resources](#)
 - [RegD-is the high filter ACE signal sent to dynamic regulating resources](#)

Resource owners will send to PJM:

- ~~TReg~~—Total Regulation ([TRegA or TRegD](#)). This is the real-time fleet regulation capability (MW) that represents the active resource owner's ability to regulate. Ideally the value of this quantity should be the sum of the resource owner's non-zero AReg quantities for the majority of the hour, but must reflect any reductions



in regulating capability as they occur (resource's AGC limit restrictions, unit LFC limit restrictions, resource "off control" conditions, etc.). This value shall be calculated every 2 seconds and sent on a 2-second scan rate. A fleet owner must separate the fleet so resources following RegA report TRegA and resources following RegD report TRegD.

Formatted: Font: Not Italic, Font color: Auto

- CReg—Current Regulation (CRegA or CRegD). This is the real-time fleet regulation feedback (+/- MW) that represents the active position of the fleet with respect to the +/- TReg capability. Ideally, the value of this quantity will track the RegA signal if the regulating fleet is responding as prescribed. This value shall be calculated every 2 seconds and sent on a 2-second scan rate. A fleet owner must separate the fleet so resources following RegA report CRegA and resources following RegD report CRegD.
- For hydro resources that have no economic offer these resources must submit the resource(s) midpoint.

Resource owners may send to PJM if the resource owner will be using a performance group for evaluation:

Formatted: Font: Not Italic

Formatted: Font: Not Italic

Formatted: Font: Not Italic

- Resource Allocation – Individual unit allocation may be sent to evaluate resource response. Allocation should be sent as percent allocation for each individual regulating resource of the resource AReg. When the resource is not assigned it will send either a 0 %. Resources without an associated allocation signal will be scored on a proportional basis.
- Operational Midpoint – the point around which the regulating resource (unit, plant or registration) operates. If not sent then PJM will use proportional allocation and economic setpoint.

Formatted: Font: Not Italic

Formatted: Indent: Left: 0.75", No bullets or numbering

Formatted: Font: Not Italic

Formatted: No bullets or numbering

4.4.3 Determining Regulation Assignment

The PJM RTO's Regulating Requirement is a function of the day's load forecast, as determined by the PJM dispatcher. Each LSE is required to provide a share of the PJM Regulating Requirement. An LSE's actual hourly Regulation obligation is determined for the hour, after-the-fact, based on the LSE's total load in the PJM RTO, as follows:

$$\text{LSEs Regulation Obligation} = \left(\frac{\text{LSEs Load Allocation \%} \times}{\text{PJM Assigned Regulation}} \right)$$

An LSE may satisfy its Regulation obligation by any of the following methods:

- Self-Scheduled Resources — An LSE can satisfy its Regulation obligation by self-scheduling Regulation.
- Bilateral Transaction — An LSE can make contractual arrangements with other PJM Members that are able to provide Regulation service.
- PJM Regulation Market Purchases — An LSE can purchase its Regulation obligation from the PJM Regulation Market, i.e., from the excess Regulation capability provided to PJM by Resource owners.



All Regulation offers reported to PJM must provide Regulation that has a quality standard of 75% or greater, as established by verification testing.

PJM Actions:

- Prior to the beginning of each day, PJM dispatcher determines the PJM RTO Regulating Requirement as follows:
 - The PJM [on-peak](#) -Regulation Requirement is [.94-0](#) % of the PJM Balancing area's peak load forecast, as determined prior to the operating day.
 - [The PJM off-peak Regulation Requirement is .9 % of the PJM Balancing area's valley load forecast, as determined prior to the operating day](#)
- At 2230, PJM provides the following information to the Transmission Owners/Generation Owners for the LSE's, via the PJM ALL-CALL:
- PJM RTO Regulation Requirement for the following day.

PJM Members Actions:

- Each LSE determines its estimated Regulation Obligation for the operating day based on its own forecast load and the information received via the PJM ALL-CALL.
- Resource owners view the hourly regulation market results via eMKT (available at least a half an hour before the operating hour) as to those resources to which regulation has been assigned. Resource owners that have self-scheduled Regulation on any of their resources inform the PJM dispatcher when those resources are on line and able to provide the self-scheduled Regulation.
- Once regulation on a resource is self-scheduled by a resource owner, it is no longer eligible to participate as a pool assigned regulating resource for the current operating day.
- If purchasing Regulation from another entity, the buyer and seller negotiate the transaction and the buyer submits the transaction through the Regulation Bilateral page of eMKT. The seller must then confirm the transaction via eMKT by 4:00pm the day after the operating day. The rules for these transactions are described in more detail later in this section of the manual.

4.4.4 Dispatching Regulation

PJM obtains the most cost efficient Regulation Ancillary Service available, as needed, to meet the PJM RTO's Regulation Requirement. PJM assigns Regulation in economic order based on the total cost of each available resource to provide Regulation, including real time opportunity cost and the resource's Regulation offer price. The AR signals are then automatically sent to the Resource Owners. Resource Owners are responsible for maintaining unit regulating capability. Exhibit [139](#) shows how the Regulation is assigned to the resources.

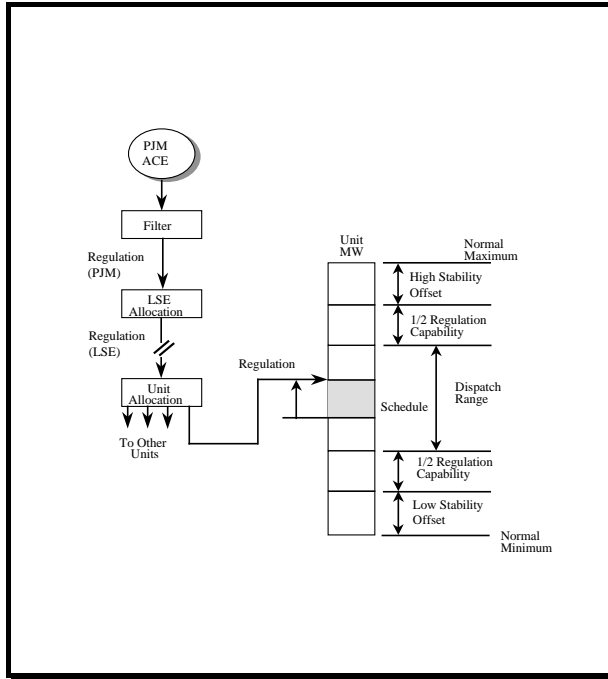

Exhibit 13: Area Regulation Assignment

PJM dispatcher re-assigns regulating capability as necessary to meet the PJM Balancing area's Regulating Requirement. Market Sellers must comply with Regulation dispatch signals that are transmitted by PJM. Market Sellers must operate their regulating resources as close to desired output levels, as practical, consistent with Good Utility Practices.

Regulation Deficiency

After the initial Regulation assignments are made, and throughout the operating hour, PJM Members report changes to their resource's regulating capabilities either by a phone call to PJM or by virtue of the TReg signal(s), each company sends to PJM. If a resource becomes unable to supply its assigned amount of Regulation, the PJM dispatcher must de-assign deficient resources and assign replacement Regulation to ensure that the total Regulation requirement is met. Such assignments are made economically based on each available resource's total cost to provide regulation, including real time opportunity cost and the resource's regulation offer price.

If, after assigning all available Regulation, the PJM Regulating Requirement is still not met, PJM dispatcher operates the system without the required amount of Regulation, logging such events.



In the event there is a loss of EMS communication between PJM and a resource owner, Current Regulation Assignments must be reassigned to another Resource Owner until EMS communication is reestablished.

Regulation Excess

If during the period an excess in assigned Regulation occurs and the total PJM RTO Regulation value exceeds the objectives by 15 MW or more, PJM dispatcher de-assigns Regulation economically based on each resource's total cost to provide regulation, including real time opportunity cost and the resource's regulation offer price.

PJM Actions:

- PJM dispatcher continuously monitors the Regulation deviation to assess Resource Owner fleet capability and reassigns Regulation as required.
- PJM's accounting staff determines the billing for the regulating service, according to the procedures in the ***PJM Manual for Operating Agreement Accounting (M-28)***.

PJM Member Actions:

- When initial assignments and reassignments are made, each affected Resource Owner dispatcher then updates the entity's regulating capability as defined by the Resource Owner TReg value.
- Participants report to the PJM dispatcher changes (of at least +/- 1 MW for duration greater than 15 minutes) to assigned Regulation capability.

Bilateral Transactions

One PJM Member may sell Regulation Ancillary Service to another PJM Member. The two members must agree on the MW amount of capability being sold, schedule Regulation accordingly, and submit the two-PJM Member Regulation transaction to PJM via eMKT.

PJM Actions:

None.

PJM Member Actions:

- All two-PJM Member transfers of regulating capability must be submitted as MW amounts via eMKT.
- The two members agree on the amount and duration of the Regulation transaction prior to the sale.
- The "buying" member submits the MW amount of the two-PJM Member transaction, the selling member, and the start and end time of the transaction via eMKT.
- The "selling" member confirms the transaction via eMKT by 4:00pm the day after the operating day.



4.5 Qualifying Regulating Resources

In order to ensure the quality of Regulation supplied to control the PJM RTO, a quality standard is developed. A resource must meet the quality standard to be permitted to regulate.

In general, there are two phases to qualifying a regulating resource:

- Certifying the resource
- Verifying regulating capability

An Area Regulation (AR) test is used for both certifying and verifying regulating capability for a resource.

Note: It must be emphasized that the Regulation test is not intended to test a resource's governor response to power system frequency changes.

4.5.1 Regulation Test Qualification Test

Traditional Resources

The AR test is run during a continuous 40-minute period when, in the judgment of PJM test administrator, economic or other conditions do not otherwise change the base loading of the resources that are being tested. Changes in base loading for a resource during the test period invalidate the test for that resource. [A separate set of tests are required for qualification for the traditional signal \(RegA\) and the dynamic signal \(RegD\).](#)

[The test follow a simulated RegA signal. The test will last for 40 minutes.](#)

[During the AR test, the AR signal is fixed for the following four ten-minute periods:](#)

- [T0-T10](#)
- [T10-T20](#)
- [T20-T30](#)
- [T30-T40](#)

[The following steps describe the implementation of the test. It is assumed that the first non-zero AR signal is positive. \(Note that the corresponding sequence in which the first non-zero AR signal is negative is equally valid.\)](#)

- [Step One: T0-T10](#) — [During this time period, the AR signal is equal to zero. This is the initiation of the AR test. This ten-minute period is provided so that the regulating resource settles at its base loading. At T10, the actual loading is sampled and the resulting value defines the base loading for that resource.](#)
- [Step Two: T10-T20](#) — [During this 10-minute period, the AR signal is set to full raise.](#)
- [Step Three: T20-T30](#) — [During this 10-minute period, the AR signal is set to zero.](#)

Formatted: Heading 4

Formatted: Font: Not Italic, Font color: Auto

Formatted: Font: Not Italic, Font color: Auto

Formatted: Font: Not Italic, Font color: Auto

Formatted: Font: Not Italic, Font color: Auto

- **Step Four: T30-T40** — During this 10 minute period, the AR signal is set to full lower.
- **Step Five: T40** — At this time, the AR signal is set to zero to terminate the test.

Exhibit 10 illustrates the Regulation test pattern.

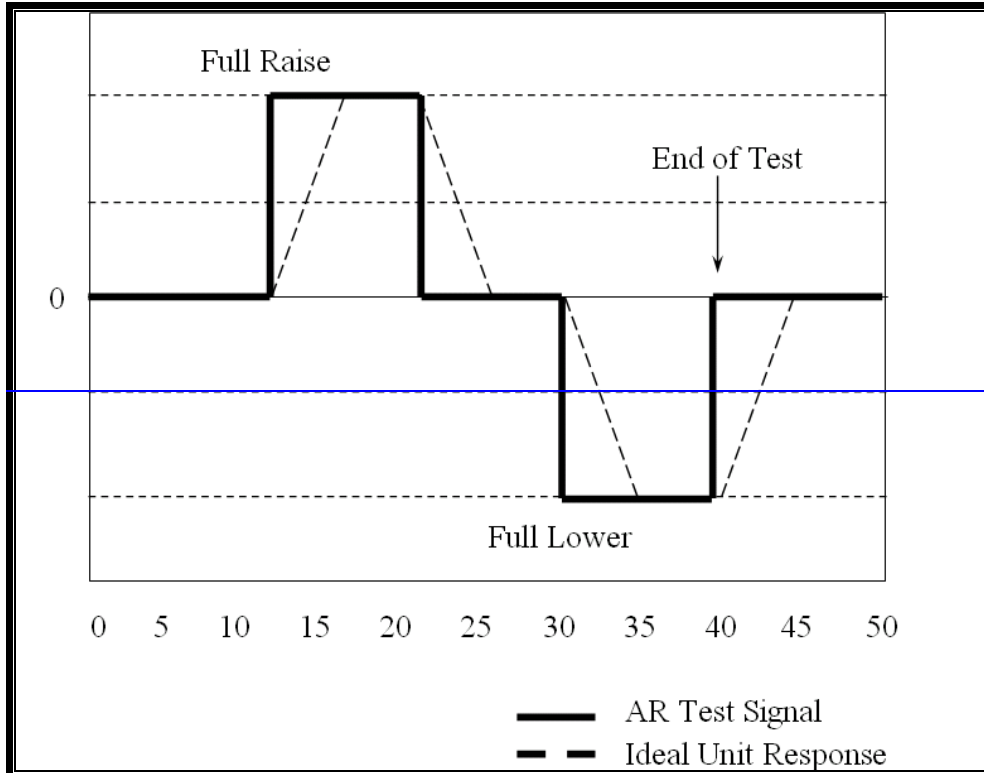

Exhibit 14: Regulation Test Pattern

Once an AR test is announced, a Resource Owner is not permitted to change any resource's Regulation assignment.

[Scoring the AR test is based on compliance to the Performance Score Calculation as described in §4.5.6 Performance Score Calculation of this manual. The score is evaluated on the entire 40 minute test period.](#)

Dynamic Resources

[The qualification test procedures described above, for resources that will follow the dynamic regulation signal \(RegD\) are the same as the qualification test for RegA. For each test, resources will follow a signal for 40 minutes and be scored using the performance score](#)

- Formatted: Heading 4
- Formatted: Font: Not Italic, Font color: Auto
- Formatted: Font: Not Italic, Font color: Auto
- Formatted: Font: Not Italic, Font color: Auto
- Formatted: PJM_Normal, Indent: Left: 0"
- Formatted: Font: Not Italic, Font color: Auto



calculation. Resources must complete a separate set of tests to qualify for the traditional signal (RegA) or the dynamic signal (RegD).

Scoring the AR test is based on compliance to two calculations:

- **Rate of Response Compliance**—The rate of response compliance is a measure of a resource's ability to achieve its Regulation assignment within five minutes.
- **Regulation Mismatch Compliance**—The Regulation mismatch compliance is a measure of a resource's ability to maintain its actual loading at a constant desired level for five minutes.

These two compliance values are averaged to yield a test score.

The Rate of Response Compliance is an average of three compliance calculations corresponding to the end of each of the three five-minute ramping periods (T15, T25, and T35) during the test.

The Rate of Response Compliance is determined as follows:

- At T15, the actual loading of the resource is sampled. This value is called AG15. Note, this is the actual loading and includes both the base generation and the AR response.

The Rate of Response Compliance at time T15 (RORC15) is:

$$RORC15 = 100 \left[\left(\frac{ABS (Base Loading + AR Signal - AG15)}{Resource's Assigned AR} \right) \times 100 \right]$$

- This calculation is repeated at T25 and T35, yielding RORC25 and RORC35.
- The Rate of Response Compliance is:

$$Rate\ of\ Response\ Compliance = \frac{RORC15 + RORC25 + RORC35}{3}$$

The Regulation Mismatch Compliance is an average of three mismatch calculations, corresponding to samples taken during three, five minute periods when the resource response yields an actual loading equal to the base loading, plus the AR signal. These time periods are T15-T20, T25-T30, and T35-T40. During these time periods, the actual loading is sampled.

- During the time period T15-T20, a number of samples, n, of actual loading, AG1, AG2, ..., AGn, are taken. The mismatch for the M20 period is:



$$M20 = \frac{\sum_{i=1}^n \left[100 - \left(\left(\frac{\text{ABS}(\text{Base Loading} + \text{AR} - \text{AG}_i)}{\text{Resource's Assigned AR}} \right) \times 100 \right) \right]}{n}$$

where $\text{AG}_i = \text{AG}_1, \text{AG}_2, \dots, \text{AG}_n$

- This calculation is repeated for T25-T30 and T35-T40, yielding M30 and M40, respectively.
- The Regulation Mismatch Compliance is:

$$\text{Regulation Mismatch Compliance} = \frac{M20 + M30 + M40}{3}$$

The AR test score is determined by averaging the two compliance values.

$$\text{Test Score} = \frac{\text{Rate of Response Compliance} + \text{Regulation Mismatch Compliance}}{2}$$

The range for a valid test score is zero to one hundred percent. Test score results that are equal to 100% indicate the perfect, idealized response. All non-ideal responses yield positive values that decrease as the responses deviate from 100%. Any negative test results default to zero. A valid test requires a continuous 40-minute period of uncorrupted test data. In the event that test data is of questionable integrity, validation is handled on a case-by-case basis.

PJM Actions:

- PJM Performance Compliance will score the test using the performance score calculation as described in section 4.5.6 Performance Score Calculation of this manual within three business days of the test.
- PJM Performance Compliance will send results of test to the generation owner within three business days.

PJM Member Actions:

- May contact PJM Performance Compliance at least a day prior to testing stating a regulation test will occur and include the following information: the resource name and eMKT identification number, the time of the test, the amount of MWs being tested and what signal the resource will test on.
- Contacts the PJM Dispatch at least 60 minutes in advance of a PJM administered test for test scheduling and approval. Contacts PJM Performance Compliance at least 60 minutes before the start of the test to ensure that test can be scored by the Performance Score Calculation Engine (PSCE).

- Formatted: Font: 12 pt
- Formatted: PJM_Heading_6, Indent: Left: 0"
- Formatted: Font: Not Italic, Font color: Auto
- Formatted: PJM_Bullet_Paragraph_1, No bullets or numbering
- Formatted: Intense Emphasis, Font: Not Italic, Font color: Auto
- Formatted: Intense Emphasis
- Formatted: Font: Not Italic, Font color: Auto
- Formatted: PJM_Normal, Indent: Left: 0"
- Formatted: Font: 12 pt
- Formatted: PJM_Heading_6, Indent: Left: 0", First line: 0"
- Formatted: PJM_Bullet_Paragraph_1, No bullets or numbering
- Formatted: Font: Not Italic, Font color: Auto

4.5.2 Certifying Regulating Resource



A resource may be certified only after it achieves three consecutive scores of 75% or above. Resources providing dispatchable energy and regulation service need to provide testing at the low economic and high economic regulation limits.

The first of these tests may be performed internally by the member, ~~following the PJM Regulation test procedure.~~ To perform a self test the member must use the PJM test shape posted on the Market Based Regulation page on PJM.com fed into the resource owner's EMS. Additionally, the member must notify the Notification to perform a regulation test must be made to the PJM dispatcher PJM Performance Compliance at least 20 60 minutes before the test. The Resource owner should also notify PJM Dispatch who will make a determination whether the test can be run. The resource should be set to unavailable during the test, though the other units may continue to regulate. Up to three tests may be performed on a resource each day.

The remaining tests should be administered by PJM Dispatch. The resource owner should contact PJM Dispatch and PJM Performance Compliance at least 60 minutes before the test though 24 hour notice is preferred. For a PJM administered test, all resource(s) will be taken out of the regulation market for the specific signal. PJM's Dispatcher makes the final determination about whether a PJM administered test can be performed. Only one test may be performed on a resource each day.

PJM Actions:

- PJM Performance Compliance will certify a resource after three consecutive successful tests of 75% or better and make change to enable regulation offers to reflect the new certification within 1 business day.
- PJM Dispatcher determines if a self scheduled test or PJM administered test can be performed.
- PJM maintains a historical database of individual resource Regulation test results and calculates all appropriate compliance information. Individual test results are provided via email to each participating LSE within three business days to facilitate a review and validation of results at the participant level.

PJM Member Actions:

- Before a self – administered test, resource owner notifies PJM Performance Compliance and PJM Dispatch. Before a PJM administered test, the resource owner notifies PJM Performance Compliance and PJM Dispatch.
- For any tests performed by the members for the purpose of certification, the member will supply the resource, the time of the test amount of MW being tested and the signal the resource is following to RegulationTesting@pjm.com.
- Resource owner uses posted test shape on Markets & Operations>Ancillary Services>Market Based Regulation page located at <http://www.pjm.com/markets-and-operations/ancillary-services/mkt-based-regulation.aspx#SliderItem3> for self administered test.
- Resource owner will set the resources specific operation setpoints for each resource to test around.

Formatted: Indent: Left: 0.75", No bullets or numbering

Formatted: Font: Not Italic



4.5.3 Certifying Multiple Combustion Turbines or Hydro Units at a Single Site

Combustion Turbines and Hydro-generators operating under a single plant control system must have a minimum of three tests of the control system. In addition, the performance of the each of the units being certified must be demonstrated in at least one of these tests. The test format must follow PJM Regulation test procedure. High and low band requirements do not apply for CTs and Hydro units being certified. The resource will be evaluated based on the Operational Midpoint of the grouped resources and the Resources Allocation as described in section 4.4.2-Telemetry Supporting Regulation Operation of this manual.

Formatted: Intense Emphasis

Formatted: Intense Emphasis

4.5.4 Increasing Regulation Capability on a Resource

One Regulation Certification Test is required for each market resource to increase the Regulating Capability on the resource. This test ~~may be ust be~~ administered by PJM ~~or may be a self test administered by resource owner using the PJM test shape posted on the Markets and Operations page fed into the resource owner's EMS.~~ Additionally, the member must notify the PJM Performance Compliance and PJM Dispatch at least 60 minutes before the test. The resource should be set to unavailable during the test, though the other units may continue to regulate.

PJM Actions:

- PJM maintains a historical database of individual resource Regulation test results and calculates all appropriate compliance information. Individual test results are provided via email to each participating LSE within three business days to facilitate a review and validation of results at the participant level.
- PJM will update the regulation bidding availability to reflect the new certification within 1 business day after a successful test.

PJM Member Actions:

- Resource owner notifies PJM Performance Compliance before a self – administered test. The resource owner notifies PJM Performance Compliance and PJM Dispatch before a PJM administered test.
- For any tests performed internally by the members for the purpose of increasing certification, the member will supply the resource, the time of the test ~~and~~ amount of MW being tested and the signal the resource is following to RegulationTesting@pjm.com.
- Resource owner uses posted test shape on Markets & Operations>Ancillary Services>Market Based Regulation located at <http://www.pjm.com/markets-and-operations/ancillary-services/mkt-based-regulation.aspx#SliderItem3> for self administered test.
- Resource owner will set the resources specific operation setpoints for each resource to test around.

Formatted: Font: Not Italic



4.5.5 Disqualification and Requalification of a Regulating Resource Continued Verification of Regulation Resources

Regulating resources that have not met performance thresholds over a specified time period will be disqualified and must re-qualify to offer into the regulating market for applicable signal type (RegA or RegD). The disqualification threshold is based on the historic performance score. The historic performance score is a rolling average actual hourly performance score for the last 100 hours a resource has operated or a weighted average of the average of the three initial or requalification scores that are then averaged with available actual hourly performance scores. The hourly performance score calculation is described in section 4.5.6 Performance Score Calculation of this manual.

Formatted: Font: Not Italic, Font color: Auto

Formatted: PJM_Normal, Indent: Left: 0"

Formatted: Font: Not Italic, Font color: Auto

Formatted: Font: Not Italic, Font color: Auto

When the historic performance score falls below 40% by signal type, PJM will notify the resource owner and the resource will no longer be eligible to offer into the regulation market for the applicable signal type.

Formatted: Font: Not Italic, Font color: Auto

Formatted: Font: Not Italic, Font color: Auto

Formatted: Font: Not Italic, Font color: Auto

Formatted: Font: Not Italic, Font color: Auto

Formatted: Font: Not Italic, Font color: Auto

Formatted: Font: Not Italic, Font color: Auto

Formatted: Intense Emphasis, Font: Not Italic, Font color: Auto

Formatted: Font: Not Italic, Font color: Auto

Formatted: Font: Not Italic

Formatted: Font: Not Italic, Font color: Auto

The resource owner may schedule a re-test as soon as practicable. When a regulating resource re-tests it will follow the testing procedure described in sections 4.5.1-4.5.3 of this manual. Upon successful completion of requalification, the regulating resource performance score starts a new rolling average without any hours from the previous period counting towards the current period's rolling average.

When a regulating resource has no historic performance available, either because it is a new resource or a resource that has requalified, the average of the qualification test scores will be used as proxy for the historic performance rolling average as follows:

$$Hour = \frac{X * Qualification Performance Score + Y * Actual Performance Score}{100}$$

Formatted: Centered

Formatted: Font: Not Italic

Where $100 - X = Y$ and Y is the number of hours after qualification. After 100 hours of actual performance scores $X \rightarrow 0$.

Formatted: Font: 11 pt, Not Italic, Font color: Auto, Check spelling and grammar

Formatted: No Spacing, Indent: Left: 0"

PJM Actions:

- Tracks rolling average of a regulating resource's performance score by signal type.
- Alerts the regulating resource's owner when performance by signal type falls below threshold.
- Blocks the disqualified resource from offering into the market.
- Monitors re-testing of the regulating resource
- Re-qualifies regulating resource.
- Notifies LSEs of a resource's certification for Regulation within three business days.

Formatted: Font: Bold, Italic

Formatted: Font: Italic

Member Actions:

Formatted: Font: Italic

Formatted: Font: Bold, Italic

Formatted: Font: Italic



- Schedules re-test to re-qualify as regulating resource status, if desired, while adhering to regulation testing guidelines.

A resource's compliance rating is defined as the sliding average of the five highest test scores (as described in the previous section) of the last seven valid AR tests, weighted by MW of Regulation assigned. If a regulating resource has a limited number of available AR test scores, the compliance rating calculation can use a minimum of three test scores:

- For a resource with three or fewer valid AR test scores, no tests are excluded from the compliance rating calculation.
- For a resource with only four valid AR test scores, exclude the lowest test score from the compliance rating calculation.
- For a resource with five or more valid AR test scores, exclude the two lowest test scores from the compliance rating calculation.

The resource's average compliance rating is then calculated as follows:

$$Compliance\ Rating = \frac{\sum (Test\ Score) \times (Assigned\ Regulating\ Capability)}{\sum Assigned\ Regulating\ Capability}$$

PJM Actions:

- PJM maintains a historical database of individual resource Regulation test results and calculates all appropriate compliance information. Individual test results are provided via email to each participating member within three business days in order to facilitate a review and validation of results at the participant level.
- If the resource's compliance rating drops below 75% the resource will be removed from the market, and must re-certify (using the procedures described in the previous section) before rejoining the regulation market.

PJM Member Actions:

- After the last certification test results are submitted to PJM, PJM notifies LSEs of a resource's certification for Regulation within three business days.

4.5.6 Performance Score Calculation

PJM will calculate the an hourly performance score, which reflects a regulation resource's accuracy in increasing or decreasing its output to provide frequency regulation service in response to PJM's dispatch signal. With the Performance Score Calculation Engine (PSCE), PJM will collect regulation signal data every 10 seconds, regulation signal data and resource operating parameters that will be inputs into the performance score. The performance score evaluates each resource's accuracy in following the AGC signal as depicted in the following Exhibit

Formatted: Font color: Auto

Formatted: Font color: Auto

Formatted: PJM_Heading_3, Indent: Left: 0", First line: 0"

Formatted: Font: Arial, 11 pt

Formatted: Font: Arial, 11 pt

Formatted: Font: Arial, 11 pt

Formatted: Font: Arial, 11 pt

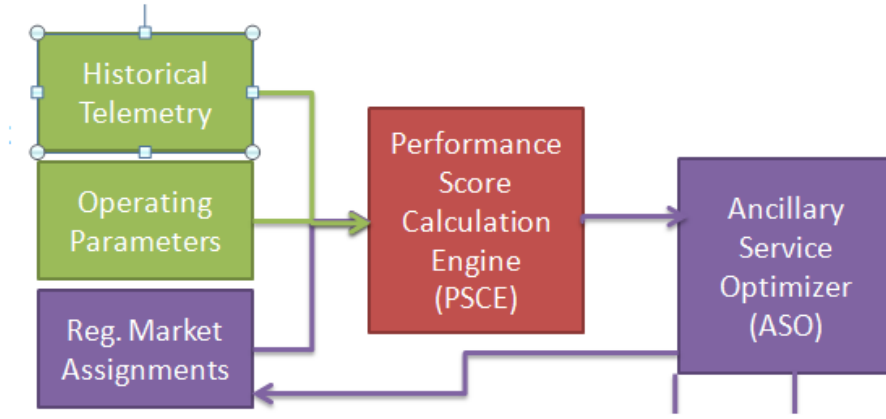

Formatted: Font: Arial, 11 pt

PSC Assumptions

Unless a resource elects to send additional data to detail operational decisions described below, it is assumed that resources are allocating regulation control signal proportional and operating around the PJM IGD set point. If a resource elects to use other than proportional dispatch the resource must send Operation Midpoint and Resource allocation described in section 4.4.2 Regulation Signals of this manual.

Formatted: Font: 11 pt

Formatted: Heading 4

Formatted: Indent: Left: 0"

Formatted: Font: 11 pt

Formatted: Font: 11 pt

Formatted: Font: 11 pt

Formatted: Font: (Default) Times New Roman, Not Italic, Font color: Auto

Delay and Correlation Score

For each 10 second interval starting from Time 0 +10, PJM will calculate a Delay Score to quantify the delay in response between the regulation signal (RegA) and the resource change in output. To calculate the match, use the statistical correlation function (r), which measures the degree of relationship between the two signals. By shifting the time periods to compare the signals, delay (δ) is defined at the point in time of the maximum correlation between the two signals. This generates both a Correlation and Delay Score as

Formatted: Font: 11 pt, Not Italic, Font color: Auto

Formatted: No Spacing, Indent: Left: 0"

$$\text{Correlation Score}_{\delta=0 \text{ to } 5 \text{ Min}} = r_{\text{Signal, Response}(\delta, \delta+5\text{Min})}$$

$$\text{Delay Score} = \text{Abs} \left| \frac{\delta - 5 \text{ Minutes}}{5 \text{ Minutes}} \right|$$

where the Delay score allows a 10 second latency for signal propagation delay for regulating resources.

Formatted: Font: 11 pt, Not Italic, Font color: Auto

Formatted: No Spacing, Indent: Left: 0"



Correlation and Delay are determined together by finding the 10 second interval with the highest coincident Correlation and Delay score. The 10 second interval that will determine Correlation and Delay for each scoring period is:

$$\max_{\delta = 0 \text{ to } 5 \text{ Min}} (\text{Delay Score} + \text{Correlation Score})$$

Correlation during Periods of Zero Slope

In the event that the regulation signal or response has a zero slope, if the standard deviation of the regulation signal is less than a threshold value, then the Correlation shall be calculated as the 1 - absolute difference between the slope of the regulation signal and the slope of the response. The performance score for Correlation and Delay will be calculated by using linear regression to find the slopes of the regulation signal and the resource response.

Precision Score

For each 10 second interval starting from Time 0 +10, PJM will calculate a Precision Score as a function of the difference in the energy provided versus the energy requested by the regulation signal while scaling for the number of samples. For each 10 second sample averaged over an hourly basis, PJM calculates the Precision Score as the absolute error (ϵ) as a function of the resource's regulation capacity, as

$$\text{Error} = \text{Average of Abs} \left| \frac{\text{Response} - \text{Regulation Signal}}{\text{Hourly Average Regulation Signal}} \right|$$

$$\text{Precision Score} = 1 - \frac{1}{n} \sum \text{Abs}(\text{Error})$$

Where n is the number of samples in the hour and the precision allows a 10 second latency for signal propagation delay for regulating resources.

Performance Score

For each 10 second set of calculations the performance score will be averaged over a five minute period for PJM will determine a composite Performance Score per resource as a unit-less scalar ranging from 0 to 1. The Performance Score will be a weighted average of the performance score components, as

$$\text{Performance Score} = \max(A * (\text{Delay Score}) + B * (\text{Correlation Score})) + C * (\text{Precision Score})$$

Formatted: Font: 11 pt

Formatted: Indent: Left: 0", First line: 0"

Formatted: Heading 4, Indent: Left: 0"

Formatted: Font: 11 pt, Not Italic, Not Highlight

Formatted: Font: 11 pt, Not Italic, Not Highlight

Formatted: Font: 11 pt, Not Italic, Not Highlight

Formatted: Font: 11 pt, Not Italic

Formatted: Font: (Default) Times New Roman, Font color: Auto

Formatted: Indent: Left: 0", First line: 0"

Formatted: Font: (Default) Times New Roman, 14 pt, Font color: Auto

Formatted: Font: 11 pt, Not Italic, Font color: Auto

Formatted: No Spacing, Indent: Left: 0"

Formatted: Font: 11 pt, Not Italic, Font color: Auto, Not Highlight

Formatted: Font: 11 pt, Not Italic, Font color: Auto

Formatted: No Spacing

Formatted: Centered

Formatted: Font: 11 pt, Font color: Auto

Formatted: No Spacing

Formatted: Font: 11 pt, Font color: Auto

Formatted: Font: 11 pt, Not Italic, Font color: Auto

Formatted: No Spacing, Indent: Left: 0"

Formatted: Font: 11 pt, Not Italic, Font color: Auto

Formatted: Font: (Default) Times New Roman, Font color: Auto

Formatted: Indent: Left: 0", First line: 0"

Formatted: Font: 11 pt, Not Italic, Font color: Auto

Formatted: No Spacing, Indent: Left: 0"

Formatted: No Spacing

Formatted: Font: 11 pt, Not Italic, Font color: Auto

The component scalars may range from 0 to 1, but must total to 1 will be weighted equally with each at 1/3. For periods when assigned regulation is 0, no score will be calculated. Correlation, Delay and Precision will be calculated with all applicable samples. Null scores will not be included in the hourly average performance score.

PJM Actions:

- PJM will calculate the Performance Score for each regulating resource after the operational hour and report the score to resource owners.

Member Actions:

- None

4.5.7 Use of Performance Groups in the Performance Score

Resources may elect to use a performance group for performance score evaluation. Performance groups can only be created for resources that satisfy one of the following criteria:

- Resources not eligible for LOC and total to less than or equal to 10 MWs across Transmission Owner boundaries.
- A performance group can be any number of resources not eligible for LOC inside a transmission owner's boundary.
- Resources within a fleet with equivalent applicable offers and point of interconnection.

Resources that are part of a performance group will send the Operational Midpoints and Resource Allocation of the group TReg for the grouped resources by signal type 4.4.2 Data Transfer. Each resource will be metered independently.

PJM Actions:

- PJM will received additional control data to be used in the Performance Score Calculation to be reflect resource owner's dispatch.

Member Actions:

- Resource owners will notify PJM via RegulationTesting@pjm.com that they satisfy one of the Performance Group criteria.
- Resource owners will add required information to their data transfer link to PJM.

4.6 Black Start Service

Formatted: No Spacing, Indent: Left: 0"

Formatted: Font: 11 pt, Not Italic, Font color: Auto

Formatted: Font: 11 pt, Not Italic, Font color: Auto, Not Highlight

Formatted: Font: 11 pt, Not Italic, Font color: Auto, Not Highlight

Formatted

Formatted

Formatted: No Spacing, Indent: First line: 0"

Formatted: Heading 2, NPB, Indent: Left: 0"

Formatted: Font: (Default) Arial

Formatted

Formatted: Font: (Default) Arial, Not Italic

Formatted: Heading 2, NPB, Indent: Left: 0"

Formatted: Font: (Default) Arial

Formatted

Formatted: No Spacing, Indent: First line: 0"

Formatted: Font: Not Italic, Font color: Auto

Formatted: Indent: Left: 0", First line: 0"

Formatted

Formatted

Formatted

Formatted

Formatted

Formatted

Formatted

Formatted

Formatted

Formatted

Formatted

Formatted

Formatted

Formatted

Formatted

Formatted

Formatted

Formatted

Formatted

Formatted

Formatted

Formatted

Formatted

Formatted

Formatted

Formatted

Formatted

Formatted

Formatted

Formatted: No Spacing, Indent: First line: 0"



Black Start capability is necessary to restore the PJM transmission system following a blackout. Black Start Service shall enable PJM and LCCs to designate specific generators whose location and capabilities are required to re-energize the transmission system.

These designated resources, called black start units, are generating units that are able to start without an outside electrical supply or the demonstrated ability of a unit with a high operating factor (subject to PJM approval) to remain operating, at reduced levels, when automatically disconnected from the grid. The planning and maintenance of adequate black start capability for restoration of the PJM balancing area following a blackout represents a benefit to all transmission customers. All transmission customers must therefore take this service from PJM.

Black Start Service can be provided by units that participate in system restoration. Such units may be eligible for compensation under the Black Start Service. If a partial or system-wide blackout occurs, Black Start Service generating units can assist in the restoration of the PJM balancing area. Specific generating units identified in specific Transmission Owners' local restoration plan(s), have the capability and training required to start-up without the presence of a synchronized grid to provide the necessary auxiliary station power.

The Transmission Owner restoration plans are implemented if a partial or complete system blackout occurs.

4.6.1 Additional PJM Requirements

The following is a summary of PJM Manuals that include information about PJM requirements for providing Black Start Service:

[PJM Manual M12: Balancing Operations](#)

- Section 4: Providing Ancillary Services, Black Start Service
- Attachment C: PJM Black Start Test Report Form - includes link to forms on PJM website:
 - PJM Black Start Test Form
 - PJM Auto Load Reject Test Report Form
 - PJM Black Start Formulaic Cost Data Form
 - PJM Black Start Actual Cost Data Form

[PJM Manual M10: Pre-Scheduling Operations](#)

- Section 2: Outage Reporting, Planned Outage Restrictions for Black Start Units

[PJM Manual M01: Control Center Requirements](#)

- Section 4: Meter Accuracy Standards

[PJM Manual M14D: Generation Operational Requirements](#)

- Section 9: Black Start Replacement Process
- Attachment E: PJM Generator Reactive Capability Testing

[PJM Manual M27: Open Access Transmission Tariff Accounting](#)

- Section 7: Black Start Service Accounting

4.6.2 Restoration Assumptions

Transmission customers must purchase black start capability from PJM. Generation resources providing this service must successfully pass the requirements for black start capability.

The LCCs in conjunction with PJM are responsible for identifying the generating units that are critical for PJM balancing area system restoration. During restoration activities, the LCC manages and deploys the black start capability, as needed, depending on the specific situation.

The LCCs have developed and shall periodically review the Restoration Plan at least once every five years. The LCCs in conjunction with PJM may amend this restoration plan and determine black start requirements to account for changes in the system configuration if either determines that additional black start resources are needed. PJM has the flexibility to seek offers for new resources whenever it amends the current plan.

PJM is responsible for coordinating payments for all black start capability directly to the generating facilities that provide the service. Credits and charges are determined as described in [PJM Manual 27: Open Access Transmission Tariff Accounting](#). Cost recovery provisions for Black Start Service units are detailed in PJM Open Access Transmission Tariff (OATT) Schedule 6A" Black Start Service".

4.6.3 Jurisdiction

Following the complete loss of system generation (blackout), it will be necessary to establish initial generation that can supply a source of electric power to other system generation and begin system restoration. These initiating generators are referred to as system black start generators. They must be able to self-start without any source of off-site electric power and maintain adequate voltage and frequency while energizing isolated transmission facilities and auxiliary loads of other generators. Generators that can safely reject load down to their auxiliary load or an isolated island of load are another form of black start generator that can aid system restoration.

4.6.4 Definitions

- **Black Start Unit** – A single generator that is able to start without an outside electrical supply or the demonstrated ability of a base load unit to remain operating, at reduced levels, when automatically disconnected from the grid.
- **Black Start Plant** – A plant that includes a unit that can black start. A Black Start Plant with black start units at different voltage levels (electrically separated) will be considered multiple Black Start Plants.

4.6.5 Objectives of Determining Black Start Criticality

- Provide sufficient amount and redundancy of black start resources to initiate an orderly restoration of critical transmission system components and provide cranking power to generation facilities within PJM.
- Provide sufficient off-site power to ensure restart for nuclear facilities within PJM within the acceptable time-frame.



- Provide operational flexibility to address alternate system restoration scenarios as required by facility failures and outages.
- Critical black start generation is used to restore generator auxiliary load or other critical load to facilitate the system restoration process.

4.6.6 Assumptions

- Enough black start generation will be deemed critical to facilitate the goal of restoring the majority of the PJM RTO (80% of load) in 16 hours (recognizing other factors are involved in meeting this restoration time).
- Once a black start unit is started, it can be used to facilitate startup of other units (black start or not) at the same plant.
- Designated critical black start generation is identified as such in each Transmission Owners restoration plan.
- Redundancy of critical black start units is desirable due to possibility of unit failure to start or transmission facility failures preventing black start units from serving their intended loads.

4.6.7 Minimum Critical Unit Requirements

The PJM System Restoration Manual (M-36), Attachment A: Minimum Critical Black Start Requirement defines the minimum critical blackstart by transmission zone. In general, there must be sufficient critical blackstart to serve critical load and at least a minimum of three critical black start units for each transmission zone. Exceptions to this requirement will be heard on a case by case basis and must be approved by PJM and the PJM SOS-Transmission.

4.6.8 Critical Unit Restrictions for Eligible Compensation under the PJM Black Start Service

- No more than **three** black start units at any one black start plant will be considered critical and eligible for compensation under the PJM Black Start Service unless approved as an exception.
- Critical black start units at a plant shall be chosen to minimize the impact of transmission outages or failures on black start capability.

4.6.9 Exceptions

Transmission Owners may request additional black start (more than 3 black start units at a plant) to be considered critical for black start and thus eligible for compensation under the PJM Black Start Service through an exception process.

The exceptions must be for justifiable reliability reasons for system conditions or configurations not incorporated into this document.



Possible exceptions would be due to plant/unit limitations or restrictions, electrical (transmission) characteristics, electrical (auxiliary/balance of plant) characteristics or control characteristics.

These exceptions will be heard on a case by case basis and must be approved by PJM and the PJM SOS-Transmission.

PJM Actions:

- PJM has collected the list of critical black start units by Transmission Zone.
- PJM will analyze the critical black start units to ensure an adequate amount of black start generation exists on the system.
- PJM will analyze any exceptions to the three units per zone rule internally and through the SOS committee.

PJM Member Actions:

- PJM Transmission Owners will submit any requested changes to the critical black start list due to system configuration changes or changes to System Restoration plans to PJM Performance Compliance Department as they become known. The remainder of existing commitments to black start generators must be fulfilled unless agreed upon by the Generation Owner.

4.6.10 Product Description

Black Start Service - A generating unit is defined as “black start capable” if the following conditions are met:

- The generating unit has the ability of being started and can close an output circuit breaker to a dead bus without energy from other PJM generating units or demonstrated ability to operate at reduced levels upon automatic isolation from the grid in such a way that it meets all requirements stated in the Performance Standards and Testing sections of this document.
- The generating unit owner and PJM have agreed that the unit should be designated as black start capable.
- The generating unit is located where black start capability is determined by the LCC and/or PJM to be useful to system restoration.
- The generating unit must have the ability to close the output breaker to a dead bus within 90 minutes of the request from the local Transmission Owner or PJM.
- A generating unit that is needed for system restoration and participates in black start service tests and System Restoration Drills may be eligible for compensation under black start service.

4.6.11 Generator Owner’s Commitment

The generator owner shall be committed to provide black start capability:

- Generators shall commit initially for at least two years to provide black start service from the black start service implementation date, with an annual right to terminate by each party (the generator owner and the transmission owner) with one year's notice. In the event that neither the Black Start Unit owner nor the Transmission Owner exercises its right to terminate by providing a one year notice of termination, the commitment to provide Black Start Service automatically will be extended for an additional year to maintain a rolling two-year commitment.
- All succeeding annual commitments must be at least an additional year to maintain a rolling two-year commitment. Changes in cost may be made annually, but will become effective in the second year of commitment.
- If due to an event of force majeure a generator owner cannot provide Black Start Service, the commitment requirements stated above shall not be binding.
- In the event that a Black Start Unit fails to fulfill its two year rolling commitment to provide Black Start Service, the Black Start Unit owner shall forfeit the received monthly Black Start Service revenues for the period of its non-performance not to exceed revenues for a maximum of one year.

4.6.12 Performance Standards

Each black start unit shall meet the following performance standards:

- The ability to self-start without any source of electric power from another PJM Capacity Resource within the time defined in the system restoration Transmission LCC, as demonstrated through testing or the demonstrated ability to operate at reduced levels when automatically disconnected from the grid.
- The ability to close into a dead (de-energized) bus. This may be demonstrated by (a) physically closing the generator breaker connected to a dead bus while the unit is running or (b) by a test that simulates closing the generator breaker while only the generator side of the breaker is energized.
- If the unit has the ability to operate at reduced levels when automatically disconnected from the grid, this may be demonstrated by (a) physically removing the unit from the grid while the unit is running or (b) by a test that simulates removing the unit from the grid.
- The capability to maintain frequency under varying load. This may be demonstrated by (a) picking up an isolated block of load, or (b) by appropriate dynamic off-line testing of the governor controls.
- The capability to maintain voltage under varying load. This may be demonstrated by (a) picking up an isolated load, (b) by producing both leading and lagging VARs by varying the voltage setting while the unit is synchronized to the system, or (c) by appropriate dynamic off-line testing of the voltage controls.
- Ability for to maintain rated output for a duration as identified by the LCC System Restoration Requirements. Requirements for supply to gas fueled black start units should be considered in the LCC System Restoration Plan. Specific gas supply requirements include, but are not limited to, electric feed to gas gate



valves, or local gas compressors needed to maintain gas supply during the restoration process.

- In addition to these unit-specific performance standards, each black start generation owner must maintain procedures for the startup of black start generation at each black start generating station. These standards shall remain in effect for the duration of the commitment.

4.6.13 PJM Obligations

Generators that commit to provide Black Start Service shall not have their black start capable designation terminated within the time of their commitment. PJM shall provide at least a two-year notice to the owner or owners of generating units that are providing Black Start Service prior to terminating that unit's designation as black start capable.

Designated black start generating units shall recognize that PJM shall have the authority to ensure a minimum amount of black start capacity when deciding whether to approve generator outages. Critical black start units will have additional planned outage restrictions as defined in the Section 2 of the PJM Pre-scheduling Manual.

4.6.14 Testing

Every generating unit that is providing black start capability shall be tested to verify that it can be started and operated without being connected to the PJM power system. Black start generating unit owners/operators shall annually schedule tests of resources providing black start capability to confirm the ability of such resources to meet the applicable standards for performance and control.

Tests may be scheduled at the discretion of the generation owner, however, tests must be prescheduled with PJM prior to the test. Compensation for energy output delivered to the system shall be provided for the unit's minimum run time at the higher of the unit's cost-capped offer or real-time LMP, plus start-up and no-load costs for up to two start attempts, if necessary. Any unrecovered costs of Black Start Tests should be submitted in writing to the Manager of Market Settlements.

For units with high operating rates with the ability to remain operating at reduced levels when automatically disconnected from the grid, an opportunity cost will be provided to compensate the unit for lost revenue during the black start testing.

Annual tests shall include:

- Starting and bringing the resource to synchronous speed without assistance from a system electrical feed.
- Testing of all communication circuits.
- Simulating switching needed to connect the black start unit to the transmission system following a system blackout.
- Testing the features unique to each facility that relate to Black Start Service.

4.6.15 Testing and Training Standards and Records

Each black start generating unit shall be tested to verify it can be started and operated without being connected to the system. The black start generating unit owner/operator shall



annually test the start-up and operation of each black start generating unit. Multiple tests may be attempted following the identification and reporting of corrective actions (See the Non-performance Issues section). Testing records shall include:

- Date(s) of test(s)
- Duration of test(s) from start of test until unit is on-line
- Test conditions (ambient temperature, general weather conditions)
- Indication of whether the unit was able to start without being connected to system
- Indication of the ability to close a circuit breaker into a dead bus
- Indication of the ability to remain stable and control voltages while operating isolated from the transmission grid and supplying the source's own auxiliary load for a period of at least 30 minutes.
- Description of the cranking path of the unit.
- Description of startup of auxiliary equipment required for startup and operation of the next non-black start unit.
- Description of communications and control systems that are capable of allowing SCADA/EMS data and voice communications, as defined in the PJM Control Center and Data Exchange Requirements Manual.
- Explanation of failed test and corrective actions taken
- Description of operator training
- Dates of training
- Copies of black start procedures

Documentation of the test results of the start-up and operation of each black start generating unit shall be provided to PJM. PJM shall verify that the number, size, and location of black start capable units are sufficient to meet PJM's restoration plan expectations.

Note 1: If verification is done through simulation, the analytical analysis must be the result of dynamic studies that include the capacitive effects of cranking path circuits, unit reactive capabilities, possible steady-state and transient switching voltages, acceptable frequency, and proper modeling of large auxiliary motors required in startup.

4.6.16 Non-performance

If a unit fails a black start test, the unit is given a ten day grace period within which it may re-test without financial penalty.

If the unit does not successfully pass a black start test within the ten day grace period immediately following a failed test, monthly black start revenues will be forfeited from the time of the first unsuccessful test until the unit successfully passes a black start test.

To collect monthly black start revenues, a unit must have a successful black start test on record with PJM within the last 13 months.

PJM Actions:



- PJM Performance Compliance Department will collect and analyze the Black Start Test data as described above from each black start unit to determine each unit's eligibility for Black Start Service payments.
- PJM Performance Compliance will notify the LCC if a black start unit in their zone fails to complete a successful black start test in the required timeframe. PJM Performance Compliance will also notify the LCC when units that failed black start tests are again eligible after completing a successful test.
- PJM Performance Compliance Department will maintain the list of eligible black start units and forward any changes to PJM Market Settlements.
- PJM Market Monitoring Unit will analyze any requested generator black start cost changes on an annual basis and forward all approved revenue requirements to PJM Market Settlements. The approved revenue requirements will be applied by PJM Market Settlements to Black Start Service payments starting with the month following the submission of the black start cost changes.

PJM Member Actions:

- Black Start Generation Owners will notify PJM Performance Compliance (Blackstart@pjm.com), as well as the LCC in whose zone the black start unit operates, of expected black start test date.
- Black Start Generation Owner will notify PJM Operations prior to start of black start test.
- Black Start Generation Owners will report Black Start Test results using the PJM Black Start Test Report Form displayed in Attachment C of this manual. Generation Owners with Auto Load Reject Units will report their testing results using the PJM Auto Load Reject Test Report Form in Attachment C of this manual. Completed forms and other requested data will be submitted to the PJM Performance Compliance Department using the eDART XLS Upload Process, or by sending an email to Blackstart@pjm.com.
- Black Start Generation Owners may request changes to their Schedule 6A revenue requirements (formulaic costs) annually by completing the PJM Black Start Formulaic Cost Data Form displayed in Attachment C of this manual. Formulaic cost data requests will be reviewed and approved by the PJM Market Monitoring Unit. Alternatively, Black Start Generation Owners may request changes to their actual costs annually by completing the PJM Black Start Actual Cost Data Form in Attachment C of this manual. Completed cost data forms and other requested data will be submitted with appropriate documentation to the PJM Market Monitoring Unit for analysis using the eDART XLS Upload Process, however actual cost change requests must be filed to with appropriate documentation to the FERC for approval.



Section 5: Transmission Facility Control

Welcome to the *Transmission Facility Control* section of the **PJM Manual for Balancing Operations**. In this section you will find the following information:

- Identifies major problems and the means of correction (see “Corrective Control Strategies”).
- How PJM controls for reactive limits (see “Reactive Limitation Control”).
- How PJM controls voltage (see “Voltage Control”).
- How PJM responds to overloaded transmission facilities (see “Thermal Overloaded Transmission”).
- Description of regional reliability coordination (see “Reliability Coordination Plan”).

5.1 Corrective Control Strategies

Below are the major electrical network problems that can occur in the PJM RTO and the primary (or most effective) means of overcoming these problems. Exhibit 11 identifies the major problems as:

- Overloads (pre-post contingency/reactive) and excessive transfers between areas within the PJM RTO
- transmission system low voltage conditions
- transmission system high voltage conditions
- power system low frequency conditions
- power system high frequency conditions



PJM RTO Problems					
Typical Means of Control	Overloads & Excess Transfers	Low Transmission Voltage	High Transmissi on Voltage	Low Frequency Conditions	High Frequency Conditions
Generator Megawatt Adjustment	Raise/Lower MW			Start Up Generators	Shut Down Generators
Phase Angle Regulator Adjustment	Increase/Decrease Phase Angle				
PJM Interchange Schedule Adjustment	Adjust Import/Export MW		Increase MW Flow Across PJM Balancing area		
External Interchange Schedule Adjustment	Adjust External Interchange Schedules				
Generator Reactive Power Adjustment		Increase Excitation	Decrease Excitation		
Transformer Tap Adjustment		Raise/Lower Tap Position	Raise/Lower Tap Position		
Shunt Capacitor Switching		Connect to Grid	Disconnect from Grid		
Shunt Reactor Switching		Disconnect from Grid	Connect to Grid		
Synchronous Condenser Adjustment		Increase Excitation	Decrease Excitation		
Transmission Line Switching	Selected Line Switching		Outage Pre-studied Lines		
Circuit Breaker Switching	Change Network Topology			Change Network Topology	Change Network Topology
Pumped Storage Pump Operation	Change Pump Status	Shut Down Pumps	Start Up Pumps	Shut Down Pumps	Start Up Pumps
Pumped Storage Generator Operation	Change Generator Status	Start Up Generators	Shut Down Generators	Start Up Generators	Shut Down Generators
Customer Load Voltage Reduction	Apply As Necessary	Apply As Necessary		Apply As Necessary	
Customer Load Shedding	Apply As Necessary	Apply As Necessary		Apply As Necessary	

Exhibit 15: Corrective Control Strategies

The various available means for control to help alleviate these problems are also listed in Exhibit 11. Some of these controls are automatically applied by local closed-loop control while other controls are acted on by the individual participants upon PJM request. PJM has no direct means of controlling the generation/transmission/distribution system.

Exhibit 12 shows the type of limits that apply to various power system conditions. Nuclear power plants at various locations may have more restrictive voltage limits, imposed by



nuclear licensing obligations, than listed in Exhibit 12. In these cases, such limits are to supersede the general guidance provided in Exhibit 12.

Note: Thermal and reactive constraint control includes loading of economic generation (on cost) generation.

<i>Power System Conditions</i>		
<i>Types of Limits</i>	<i>Pre-Contingency Normal Conditions</i>	<i>Post-Contingency Emergency Conditions</i>
Thermal	Actual Flow < Normal Rating	Contingency Flow < Emergency Rating
Reactive Transfer	Equivalent MW Rating	Equivalent MW Rating
Voltage - 765 kV	726.8 kV – 803.2 kV	726.8 kV – 803.2 kV Max 8-10% kV Drop
Voltage - 500 kV	500 kV - 550 kV (494kV-540kV in DVP)	500 kV - 550 kV Max 5% kV Drop (494kV – 540 kV Max 10% kV Drop in DVP)
Voltage - 345 kV	328 kV - 362 kV	328 kV - 362 kV
Voltage - 230 kV	219 kV - 242 kV (216.2kV – 241.5kV in DVP)	219 kV - 242 kV (216kV – 241.5 kV in DVP)
Voltage - 138 kV	131 kV - 145 kV	131 kV - 145 kV
Voltage - 115 kV	109 kV - 121 kV	109 kV - 121 kV
Voltage - Customer ANSI Standard	97.5% - 105%	95% - 105.8%
Stability - Steady State	Max 60° Difference for 500 kV System	Max 50° Difference for 500 kV System
Stability - Steady State	Max 40° Difference for Generators	Max 30° Difference for Generators

Exhibit 16: Power System Limits

The next subsections describe the procedures that are followed to implement controls in response to specific problems.

5.2 Reactive Limitation Control

This section provides operating guidelines for normal and emergency control of transfer interfaces where a reactive limit is reached or exceeded.

PJM Actions:

- When a reactive limit is approached or exceeded, and non-cost moves are ineffective, out-of-merit assignments are made in the most effective areas to control these limitations. PJM dispatcher also evaluates the impact of the existing inter-area transfers and modifies the transaction schedules that adversely affect the reactive transfer limit. Prior to out of merit assignments transaction schedules that are not willing to pay congestion are curtailed. If insufficient generation is available to control these limitations, the Emergency procedures contained in the [PJM Manual for Emergency Operations](#) are implemented. If the Emergency Procedure steps (from curtailing non-firm contracts through Voluntary Customer Load Curtailment, including implementation of the NERC TLR procedure) are insufficient to control the transfers, a Manual Load Dump Warning is issued to all Generation Owners/Transmission Owners stating the most serious limitation and

the estimated amount of load relief required. PJM dispatcher using all available tools, voltage drop curves, actual voltage conditions, proximity to all the different reactive transfer limits, and Transmission Owner impacts, determines the most effective area for load dumping. PJM dispatcher discusses the locations and the amount of load drop required with the affected LSEs.

- If transfers exceed a reactive transfer limit and voltage conditions are deteriorating and PJM dispatcher determines that the system cannot withstand the occurrence of the contingency, PJM dispatcher orders a Manual Load Dump in the most effective area and in an amount sufficient to return the transfers to within the reactive transfer limit.

If transfers exceed the transfer limit (or a revised transfer limit, if applicable), due to the occurrence of some contingency, but additional actions other than load dumping are available and effective, these actions are first undertaken. If, however, transfers are not returned to within the limits within 30 minutes of the occurrence of the contingency, the PJM Emergency Procedures up to and including load dumping are implemented.

PJM Member Actions:

The Generation Owner/Transmission Owner dispatchers follow actions prescribed in the [PJM Manual for Emergency Operations](#).

5.3 Voltage Control

The PJM RTO is operated so that normal voltage profiles are maintained at all load levels. Under normal system conditions, the following criteria are used:

- Each LSE is able to supply its reactive load and losses locally at all load levels.
- The 500 kV system is operated so that all 500 kV bus voltages are maintained between 500 kV and 550 kV (494 kV and 540 kV in the Dominion area) on a pre-contingency basis. Maximum voltage capabilities on individual 500 kV buses are given in Attachment B.
- The 345 kV and below portion of the bulk power transmission system is operated so that all bus voltages are maintained within 5% of the nominal voltage on a pre-contingency basis, unless use of a different bandwidth is required because of equipment design.

No single contingency outage shall exceed either of the following limits at a 500 kV bus:

- a post-contingency voltage drop of five percent (0.20 PU in the Dominion area) on 500 kV facilities
- A post-contingency angular difference which is ten degrees less than the setting of the synchro-check relay. Synchro-check relays are set to 60° for 500 kV terminals and 40° for generators.

PJM regularly examines system conditions for potential voltage problems and advises PJM dispatcher of measures that must be taken to maintain the system within the criteria.

The Generation Owner/Transmission Owner dispatchers establish system voltage control by using controllable reactive sources and load tap changers, including generators, synchronous condensers, and switched capacitors. After the controllable reactive sources



are utilized, Load Tap Changing (LTC) transformers may be used to adjust 500 kV and 230 kV voltages.

5.3.1 Action in a Low-Voltage Situation

If voltages are, or are expected to be, below the criteria, the following actions are taken by PJM and the Generation Owners/Transmission Owners.

PJM Actions:

- PJM dispatcher requests all Generation Owners/Transmission Owners to implement the heavy-load voltage schedule.
- PJM dispatcher requests that synchronous condensers and switchable capacitors be placed in service unless studies indicate otherwise.
- PJM dispatcher verifies that all units in operation are supplying maximum MVAR capability.
- PJM dispatcher adjusts 500/230 kV transformer taps to optimize system voltage.
- If system voltages are determined to be overly sensitive to slight increases in transfer levels, PJM dispatcher reduces power transfers into the reactive-deficient area to a value that stabilizes voltages. PJM dispatcher re-examines system conditions and reduces the limit, until voltage stability is achieved.

PJM Member Actions:

- The Generation Owner/Transmission Owner dispatchers respond promptly to specific requests and directions of PJM dispatcher.

5.3.2 500 kV System Voltage Below 500 kV

If the 500 kV system voltage is below 500 kV (or 494 kV in the Dominion area), the following actions are taken:

PJM Actions:

- PJM dispatcher issues a Manual Load Dump Warning and takes appropriate Emergency procedures (see [PJM Manual for Emergency Operations](#)), in the effective area.
- If the 500 kV system voltage has reached a level of, or is decaying toward 470 kV, or any other level as determined by PJM operations planning staff, PJM dispatcher orders sufficient load dumping in the deficient area, so as to stabilize the system voltage at 490 kV or better to protect the system from a loss of a large unit.
- PJM dispatcher directs Transmission Owners, via the PJM ALL-CALL, to avoid taking any actions that adversely affect the 500 kV system voltage, without first obtaining approval from PJM dispatcher. If the 345 kV system or below has reached a level of 90% of nominal and is continuing to decay, PJM dispatcher orders load dumping in the deficient area, sufficient to return the system voltages to 95% or better.



PJM Member Actions:

- The Transmission Owner dispatchers promptly dump an amount of load equal to, or in excess of, the amount requested by PJM dispatcher.
- The Transmission Owner dispatchers report actions taken once implemented.

5.3.3 Action in a High-Voltage Situation

The following items apply to voltage control of the overall PJM 500 kV system. It should be noted that high voltage problems of localized nature may be more effectively controlled by selective measures in the particular area.

PJM Actions:

- PJM dispatcher requests the Transmission Owners to disconnect all switchable capacitors.
- PJM dispatcher requests system reactors be placed in service where available.
- PJM dispatcher requests the Generation Owners/Transmission Owners to operate units to absorb reactive power.
- PJM dispatcher requests neighboring Balancing areas to assist in reducing voltage.
- PJM dispatcher requests the Transmission Owners to adjust 500/230 kV transformer taps to optimize system voltage.
- PJM dispatcher requests the Transmission Owners to reset desired voltage on Static Var Compensators (SVCs).
- If the above is not sufficient, high-voltage problems may possibly be relieved by opening a 500 kV circuit. (Opening a circuit loaded below surge impedance loading, 850 MW, results in a net decrease in line charging). If using the EMS real-time program, PJM dispatcher determines that opening the 500 kV circuit causes no overloads, PJM dispatcher directs the Transmission Owner to open this line at both terminals. PJM dispatcher determines if this action has produced the desired effect; if not, PJM dispatcher directs the Transmission Owner to reclose the line. PJM operations planning staff routinely provide PJM dispatcher with a list of 500 kV circuits that may be opened without degrading system reliability. PJM dispatcher may not open more than one 500 kV circuit for voltage control in an area.

PJM Member Actions:

- The Generation Owner/Transmission Owner dispatchers respond promptly to specific requests and directions of PJM dispatcher.

5.4 Thermal Overloaded Transmission

This section describes the actions to be taken when there is thermal overloading of a transmission facility (line or transformer) at or above the Short-Term Emergency (STE) rating. These actions provide protection of high voltage transmission from failure and damage due to overloaded conditions and preservation of system reliability.



The general procedure is to first apply effective corrective actions that can be taken at little or no cost, for example:

- Transformer tap adjustments
- Phase-angle regulator adjustments
- Capacitor/reactor switching
- Pre-studied line switching
- Curtailment of non-firm transactions not willing to pay for congestion

5.4.1 Transaction Curtailment

PJM may curtail transactions for which the transmission customer has not indicated the desire to buy through congestion. These curtailments are accomplished in an order based on:

- Distribution factor impact on the constrained facility
- Priority of transmission service
- Timestamp of the transmission service request within each priority level

If the transactions which require curtailment are external to PJM, the NERC TLR procedure is invoked.

5.4.2 Generation Redispatch

In the event that further corrective actions are required, the outputs of effective generators are adjusted away (off-cost) from their normal assignments (on-cost).

The generation control cost signal that is sent from PJM to each Generation Owner is established either automatically by computer program or manually by PJM dispatcher (see Exhibit 5 of this PJM manual).

5.4.3 Operating Mode Change Procedure

The following procedures are applied when the PJM RTO conditions require a change in on/off-cost operating modes:

- From On-Cost to Off-Cost — When generation redispatch is necessary, the PJM dispatcher notifies all Generation Owners/Transmission Owners, via the PJM ALL-CALL, that particular Control Zones will be operating off-cost.
- From Off-Cost to On-Cost — When conditions permit the affected Generation Owners/Transmission Owners to return to economic dispatch (on-cost), PJM dispatcher notifies all Local Control Centers, via the PJM ALL-CALL, when the affected LSEs will return to on-cost operations.

A summary of PJM Constraint Control guidelines is included as Attachment B.

PJM Actions:

- When a transmission facility is loaded above the STE rating, but does not exceed the load dump rating (generally 115% of the STE rating), PJM dispatcher

requests adjustments to controllable equipment within a maximum of 15 minutes, to bring the loading to equal or below the STE rating.

- If the facility is not reduced within 15 minutes, PJM dispatcher orders a load dump to reduce the actual flow on the facility to be equal to or below the STE rating.
- When a transmission facility is loaded above the load dump rating, PJM dispatcher or Transmission Owner on the receiving end of the overloaded facility, has up to a maximum of five minutes to analyze and relieve the overload. If not reduced to or below the STE rating at the end of five minutes, PJM dispatcher orders a load dump to relieve the facility.
- PJM dispatcher promptly informs the Transmission Owner dispatcher of any overloads that have occurred and corrective actions being taken.

PJM Member Actions:

- The Transmission Owner dispatchers promptly inform PJM dispatcher of any overloads that have occurred and corrective actions being taken.
- The Transmission Owner dispatchers do not open any overloaded transmission, including inter-Balancing area and intra-Balancing area circuits, under disturbance conditions unless pre-studied or pre-arranged for specific contingencies.

If an overloaded transformer or cable cannot be relieved by applying the previous criteria, the LCC dispatcher can open the facility, while taking into account the system conditions and the resulting consequences, versus the consequences of having the facility fail and incur damage.

5.4.4 Generation Redispatch (Non-Market Facilities)

In the event that further corrective actions are required beyond non-cost actions, PJM will issue a Post-Contingency Local Load Relief Warning (PCLLRW).

At the request of the Transmission Owner, PJM will manually direct the redispatch of effective generation. The effective generation will be cost-capped but not permitted to set LMP since the facility is not a "Market" facility. PJM will commit effective generation in order to minimize the total MW committed to control the constraint.

Attachment A: PJM Instantaneous Reserve Check (IRC)

IRC - Definitions of Terms / Calculations

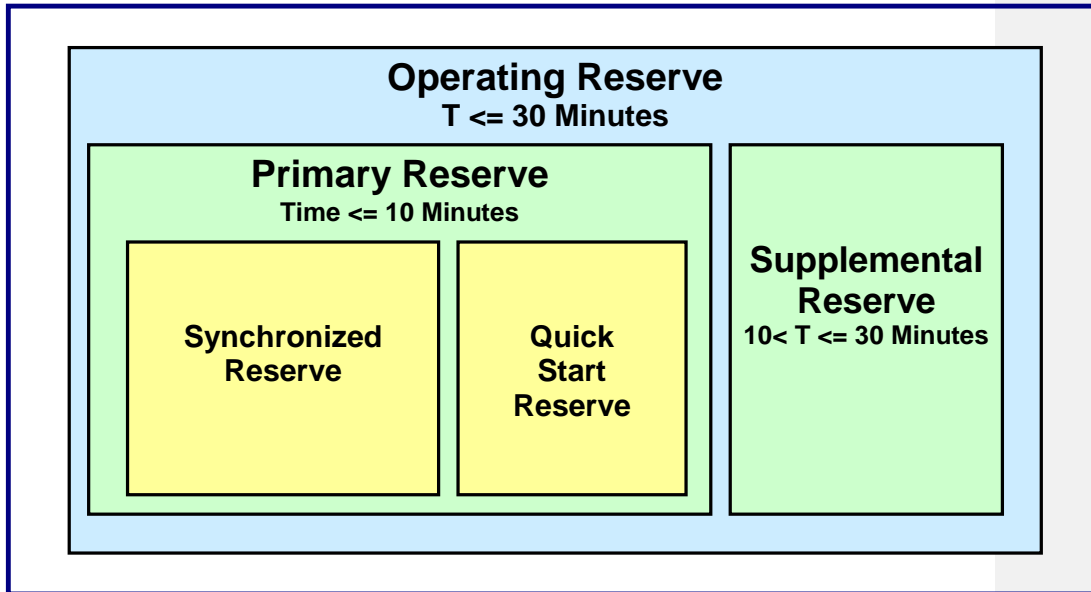

Exhibit 17: PJM Instantaneous Reserve Check Terms & Relationships



<i>Type of Reserve</i>	<i>Description/Calculation</i>
Synchronous Reserve	<p>Generation available within 10 minutes for Online Reserve Units</p> <p>1. The Synchronized Reserve is calculated as follows:</p> <ul style="list-style-type: none"> Synchronous Reserve = the lesser of: <ul style="list-style-type: none"> (a) Spin Ramp Rate * 10 min (b) Spin Max (if none exists then Economic Max is used) – Current MW Level
Quickstart Reserve	<p>Generation available within 10 minutes for Offline Reserve Units</p> <ul style="list-style-type: none"> Quickstart Reserve (Hydro) = Spin Max (if none exists then Economic Max is used) (limited by ramp rate * (10 minutes - TTS)) Quickstart Reserve (Non - Hydro) = Spin Max (if none exists then Economic Max is used) (limited by ramp rate * (10 minutes - TTS)) <p>Include: Offline Reserve Units that have a (Notification Time + TTS) ≤ 10 min</p> <p>Note: TTS = Time to Start</p>
Primary Reserve	Synchronized Reserve + Quick Start Reserve
Operating Reserve	<p>Generation available within 30 minutes for Online or Offline Reserve Units</p> <ul style="list-style-type: none"> Operating Reserve = Offline + Online Offline is calculated as follows: <ul style="list-style-type: none"> Offline = Spin Max (if none exists then Economic Max is used) (limited by Spin Ramp Rate * (30 minutes - TTS)) Include: Offline Reserve Units that have a (Notification Time + TTS) ≤ 30 min. (limited by Spin Ramp Rate * 30 minutes - TTS) Online is calculated as follows: <ul style="list-style-type: none"> Online = the lesser of: <ul style="list-style-type: none"> a) ramp rate * 30 min b) Spin Max (if none exists then Economic Max is used) – Current MW Level <p>Note: Regulating Units are permitted to be included in the operating reserve calculation.</p> <p>Note: If a Maximum Emergency Alert is issued, and Maximum Emergency is called into the capacity, Emergency Maximum should be used in place of Spin Max or Economic Maximum.</p>
Supplemental Reserve	Operating Reserve - Primary Reserve

NOTE: Reserve quantities must reflect current regulation assignments.

Exhibit 18: Definitions of PJM Instantaneous Reserve Check Terms



IRC Company Data						
Company:						
Request ID: 2179	Request Timestamp: 02/08/2011 11:24					
User Name:	Posted Timestamp:					
Company Data						
	PJMCZ	Mid Atl	AP	DLCO	CE	Western
Operating Reserve	<input type="text"/>	0	<input type="text"/>	<input type="text"/>	<input type="text"/>	0
Synchronized Reserve	<input type="text"/>	0	<input type="text"/>	<input type="text"/>	<input type="text"/>	0
Quick Start						
Hydro	<input type="text"/>	0	<input type="text"/>	<input type="text"/>	<input type="text"/>	0
Other	<input type="text"/>	0	<input type="text"/>	<input type="text"/>	<input type="text"/>	0
Supplemental	<input type="text"/>	0	<input type="text"/>	<input type="text"/>	<input type="text"/>	0
<input type="button" value="Submit Form"/> <input type="button" value="Refresh"/> <input type="button" value="Main Menu"/>						

Exhibit 19: Sample PJM Instantaneous Reserve Check Form

IRC Form Data Entry Guide

1. Request ID – IRC Identification Number
2. Request Timestamp — Date and time of the request for the IRC
3. Company Input
 - a. Operating Reserve
 - b. Synchronized Reserve
 - c. Quickstart - Quick-Start Reserve values are reported for hydro and non-hydro reserves separately
 - d. Supplemental Reserve > 30 - Scheduled capacity not available within 30 minutes.

NOTE: Reserve quantities must reflect current regulation assignments.



Attachment B: Transmission Constraint Control Guidelines

B.1 Non-Cost Measures

PJM dispatch utilizes all available non-cost measures prior to generation redispatch. Non-cost measures include but are not limited to:

- PAR adjustments
- Transformer Tap Adjustments
- MVAR adjustments
- Switching Capacitors / Reactors in/out-of-service.
- Switching Transmission facilities in/out-of-service.
- Curtailing Transactions “Not-Willing-to-Pay” congestion.

Once non-cost measures are exhausted, PJM dispatch begins to redispatch generation. PJM will initiate redispatch on a cost-effective basis using the PJM Unit Dispatch System solution. During constrained operations, PJM Dispatch will redispatch all generation, including wind, in a consistent manner. PJM assumes that, because of the intermittent nature of wind, these facilities will be at ECO Max and that further upward dispatch (increase in output) is not available for constraint control. This curtailment can be achieved by pitching blades or taking individual turbines off-line. Once off-cost operations are activated, the PJM dispatcher will set a desired “threshold” for each individual constraint, which directs the RT-SCED solution to control to the threshold % of the appropriate facility rating. Subsequent RT-SCED cases will continue to control to this percentage, usually 95 – 100% of facility rating, until the threshold is changed or constraint closed by the PJM dispatcher.

B.2 Generation Redispatch

PJM, prior to initiating redispatch, reviews available controlling actions and the distribution factor effect on the overloaded facility. PJM also considers whether there are sufficient resources available to control transmission facilities within acceptable limits.

1. Contingency Operations

PJM will initiate off-cost if reasonable controlling actions are available with an impact effect generally greater than 5%. Once off-cost is initiated, RT-SCED tools will redispatch generation based on dollar per MW effect, considering all on-line flexible units with an impact of 1% or greater. PJM staff has the ability to adjust the controlling percentage on an individual constraint basis. PJM will initiate a Post Contingency Local Load Relief Warning/Action if post-contingency flows exceed designated ratings and insufficient resources are available to control the overloaded facilities.

2. Normal / Actual Overload

In general PJM initiates off-cost and utilizes controlling actions greater than 5% impact, however, since an actual overload causes real-time loss-of-life on the affected facility, PJM will load generation with an impact effect less than 5%. Once



off-cost is initiated, the RT-SCED tool will redispatch generation based on dollar per MW effect, considering all on-line flexible units with an impact of 1% or greater. PJM staff has the ability to adjust the controlling percentage on an individual constraint basis.

The RT-SCED software continues to monitor projected flows on constrained facilities and sends ramp-limited set points to re-optimize redispatch for constraint control to the designated threshold. The eligibility of units to set Locational Marginal Price is determined by comparing the desired output as calculated by RT-SCED to the actual output as calculated by the State Estimator.

Note 1: In order to ensure resources do not force emergency procedures they must be dispatchable (Dispatchable Generation) in the range between the greater of the resource's physical minimum operating level or Capacity Interconnection Rights (CIR) and Maximum Facility Output (MFO) (i.e. fixed gen flag must not be selected).

Note 2: Resources may not submit an economic minimum that exceeds the greater of the resource's physical minimum operating level or the level of their CIR in the real-time energy market. This restriction does not apply to the day-ahead market.

Note 3: An intermittent resource's Economic Minimum shall not exceed the level of its CIR.

Note 4: An intermittent resource's Emergency Minimum should be set to 0.

Note 5: During Constrained Operations, Resources will be redispatched cost-effectively based on their bid parameters.

Note 6: Cost-effective redispatch (\$/MW effect) objective is to minimize the function $[(\text{Current Dispatch Rate} - \text{Unit Bid}) \div \text{Unit Generation Shift Factor}]$.

Note 7: The unit default cost/price bid will be assumed 0 unless provided via eMkt.

Note 8: Intermittent resource curtailment should be achieved within 15 minutes or consistent with the resources ramp rate bid. PJM should be notified if curtailment is expected to exceed 15 minutes.

PJM Member Actions:

- Generation Dispatchers ensure their units are following PJM economic base points to Economic Minimum output.
- Wind Generator Operators will adjust Wind Turbine Control Systems or manually adjust turbine output to achieve the desired RT-SCED basepoint.

B.3 Analyzing and Controlling non-market BES facilities

BACKGROUND:

PJM is responsible for monitoring for BES facilities defined as:

- All 100kV and above non-radial transmission lines.
- All non-radial transformers with a high side voltage of 100kV and above.



- Individual generation resources larger than 20 MVA or a generation plant with aggregate capacity greater than 75 MVA that is connected via a step-up transformer's) to facilities operated at voltages of 100 kV or higher,
- Lines operated at voltages of 100 kV or higher,
- Transformers (other than generator step-up) with both primary and secondary windings of 100 kV or higher, and
- Associated auxiliary and protection and control system equipment that could automatically trip a BES facility, independent of the protection and control equipment's voltage level.

A portion of the BES facilities are considered non-market BES facilities and will be controlled in a manner different than market BES facilities. Controlling actions for non-market BES facilities will be coordinated with the Transmission Owner and will not be permitted to set LMP.

PROCEDURE:

B.3.1 Outage Approval Process for BES facilities:

Reliability Engineers will evaluate and approve transmission outages consistent with the PJM Transmission Operations Manual (M03) and PJM Operations Planning Manual (M38) ensuring reliability is maintained on all BES facilities.

B.3.2 Outage Approval Process for non-market BES Facilities:

Additional coordination may be required with the Transmission Owner for non-market BES facilities to ensure contingency results are consistent in real-time operations:

- For planned outages, the differences in contingency analysis results should be rationalized in advance and instruction provided to real-time operations as to which EMS analysis is more accurate (PJM or TO).
- An operating plan shall be agreed upon in advance, which may require the advanced scheduling of long-lead time generation at the expense of the Transmission Owner.
- The agreed upon controlling actions should be documented and communicated to PJM and TO or GO Dispatchers.
- Under certain conditions, a generator may violate GSU limits upon the loss of another facility. A generator will be permitted to operate above their emergency limits so long as a post-contingency reduction plan has been agreed upon. Pre-contingency reductions would be required in the absence of an agreed upon plan.

B.3.3 Resolving Modeling Differences:

Prior to implementing controlling actions to control flows within limit criteria, PJM Dispatch compares PJM EMS Security Analysis results with Transmission Owners EMS Security Analysis Results. Pre-contingency, Post-Contingency flows and ratings are compared. If a difference exists between PJM and Transmission Owner Security Analysis results, PJM will operate to the most conservative results until the difference can be rationalized. For planned



outages, the differences should be rationalized in advance and instruction provided to real-time operations. For situations where differences were not resolved in advance and if the difference is significant, the following guides will be followed to quickly resolve the difference:

- PJM and Transmission Owner identify modeling issue and operate to most conservative solution.
- PJM investigates modeling issue and attempts to resolve within 1 hour. This may involve verification of distribution factors using Seasonal PSS/E load flow case.
- If discrepancy is > 5% and expected to last 2 hours, PJM Dispatch will contact PJM support staff and request Transmission Owner to contact support staff.
- PJM and Transmission Owner on-call support staff will work toward resolving modeling difference.
- PJM and Transmission Owner agree to defer to most accurate analysis in lieu of operating to most conservative results, when difference is understood or resolved.
- PJM and Transmission Owner support staff attempt to correct modeling differences within 24 hours.

B.3.4 Real-time Controlling Actions:

Real-time controlling actions for Non-market BES facilities are prioritized as follows:

B.3.5 Real-time Controlling Actions:

Real-time controlling actions for Non-market BES facilities are prioritized as follows:

1. Non-cost measures including:
 - PAR adjustments
 - Transformer Tap Adjustments
 - MVAR adjustments
 - Switching Capacitors / Reactors in/out-of-service.
 - Switching Transmission facilities in/out-of-service.
 - Curtailing Transactions “Not-Willing-to-Pay” congestion
2. In order to control post-contingency voltage or thermal violations, PJM will manually direct the redispatch of effective generation at the request of the Transmission Owner. The effective generation will be cost-capped but not permitted to set LMP since the facility is not a “Market” facility. PJM will commit effective generation in order to minimize the total MW committed to control the constraint.
3. Under certain conditions, a generator may violate GSU limits upon the loss of another facility. A generator will be permitted to operate above their emergency limits so long as a post-contingency reduction plan has been agreed upon. Pre-contingency reductions are required in the absence of an agreed upon plan.
4. PJM will direct pre-contingency redispatch actions to:



- a. Control for actual voltage violations below normal low limits
 - b. Control for actual thermal overloads in violation of normal ratings
 - c. Control for post-contingency voltage violations below Load Dump Low limits
 - d. Control for post-contingency violations resulting in non-converged contingencies.
5. PJM will issue a Non-market PCLLRW for a thermal contingency violation and provide post-contingency load dfax if the post-contingency flow exceeds the LTE rating.
 6. PJM will issue a Non-market PCLLRW for a voltage contingency violation and provide post-contingency load dfax if the post-contingency voltage is below the emergency limit.

B.3.6 Maintaining System Reliability:

PJM is required to ensure system reliability is maintained, ensuring there is an operating plan for all BES facilities. If PJM or a TO analysis indicates that an planned facility outage would result in non-converged contingencies, post-contingency voltages below LD voltage limits, post-contingency voltage drop violations, actual voltages below normal limits or actual flows in excess of normal ratings after all non-cost measures are exhausted, the TO will be required to schedule generation or cancel their planned outage cancelled.

Facilities in the posted information can be designated:

- “Unmonitored” or “Not Monitored”, applies to facilities which may, or may not, be modeled in the PJM EMS. No significant impact on system loading is expected to result from outages on these facilities. PJM’s EMS does not maintain ratings/limits for these facilities.
- “PJM Market” indicating that the facility is internal to PJM and is under Congestion Management. If actual or post-contingency Violations occur on these facilities, operators follow appropriate procedures including market re-dispatch to remediate problems. PJM’s EMS maintains ratings/limits for these facilities.
- “PJM Reliability” indicating that the facility is monitored by PJM for NERC Security/Reliability Coordinator obligations. This designation is also applied when coordination is required to ensure that facilities which may not be in the PJM Market are not adversely impacted by switching or phase shifter operations on parallel PJM facilities which are under Congestion Management. If actual or calculated overloads occur, operators follow appropriate procedures - excluding market re-dispatch - to remediate the problem. PJM’s EMS maintains ratings/limits for these facilities.
- “PJM Status” indicates that TOs are required to report, schedule and coordinate outages on the facility. All facilities classified as 1-PJM Market and 2-PJM Reliability Coordination are automatically included as Outage Reportables. TOs are also required to report outages on facilities that may not be in Congestion Management but may impact the reliability and/or economics of the system. TOs are required to follow applicable outage reporting procedures for facilities



classified as Reportable High/Yes and Reportable Low. The primary difference in these classifications is that for Reportable High/Yes facilities, TOs are required to call before and after taking outages whereas TOs are not required to call PJM before taking an outage on Reportable Low facilities. TOs are not required to report outages on facilities classified as Reportable No to PJM. PJM can require that any, or all, OATT facilities be Outage Reportable. PJM's EMS does not maintain ratings/limits for these facilities.



Attachment C: PJM Black Start Test Report Form

The following forms are located on the PJM Black Start Services Working Group link on the PJM website:

- PJM Black Start Test Form
- PJM Auto Load Reject Test Report Form
- PJM Black Start Formulaic Cost Data Form
- PJM Black Start Actual Cost Data Form

This link can be found at:

<http://www.pjm.com/committees-and-groups/task-forces/~media/committees-groups/task-forces/bsstf/test-report-form-2007.ashx>



Attachment D: Disturbance Control Performance/Standard

The purpose of the Disturbance Control Standard (BAL-002-0) is to ensure that PJM, a Balancing Authority, is able to utilize its contingency reserve to balance resources and demand and return Interconnection frequency within defined limits following a Reportable Disturbance. Because generator failures are far more common than significant losses of load and because contingency reserve activation does not typically apply to the loss of load, the application of Disturbance Control Standard (DCS) is limited to the loss of supply and does not apply to the loss of load.

As such, PJM is required to have access to or operate with resource reserves to respond to disturbances. This reserve may be supplied from generation, controllable load, or coordinated adjustments to interchange schedules. Further discussion of the various types of operating reserve is made in PJM Manual 10, Pre-Scheduling Operations, Section 3, Reserve Objectives. As a minimum, this reserve must be sufficient to cover the most severe single contingency and this contingency value must be reevaluated on an annual basis to determine the most severe single contingency.

The DCS Standard requires PJM to satisfy Disturbance Recovery Criterion within a certain Disturbance Recovery Period for 100% of reportable disturbances. That Criterion requires PJM to return its Area Control Error (ACE) to zero if its ACE just prior to the Reportable Disturbance was positive or equal to zero. For negative initial ACE values just prior to the Disturbance, a return of ACE is made to its pre-Disturbance value. In either case, the Disturbance Recovery Period is 15 minutes after the start of a Reportable Disturbance. Subsequently, PJM must fully restore the Synchronized Reserve within 90 minutes. All contingency losses (i.e., Disturbances) greater or equal to 80% of the magnitude of PJM's most severe single contingency loss must be calculated and reported as follows.

For loss of generation:

If $ACE_A < 0$, then

$$R_i = \frac{MW_{Loss} - \max(0, ACE_A - ACE_M)}{MW_{Loss}} * 100\%$$

If $ACE_A < 0$, then

$$R_i = \frac{MW_{Loss} - \max(0, -ACE_M)}{MW_{Loss}} * 100\%$$

where:

MW_{Loss} is the MW size of the Disturbance as measured at the beginning of the loss,

ACE_A is the pre-disturbance ACE, and

ACE_M is the maximum algebraic value of ACE measured within 15 minutes following the Disturbance. (Note: ACE_M may be set to equal $ACE_{15 \text{ min}}$).



The recording of the MW_{Loss} value should be measured at the site of the loss to the extent possible. This value should not be measured as a change in ACE since governor response (and AGC response) may introduce error.

The value for ACE_{Δ} shall be based on the average ACE over the period just prior to the start of the Disturbance (10 and 60 seconds prior and including at least 4 scans of ACE).

The average percent recovery is the arithmetic average of all the calculated R_i values for Reportable Disturbances during a given quarter. Average percent recovery is similarly calculated for excludable Disturbances.

These Disturbances are reported to NERC on a quarterly basis. Additionally, it is important to note that multiple contingencies occurring within one minute or less of each other are treated as a single contingency. However, if the combined magnitude of the multiple contingencies exceeds the most severe single contingency, the loss shall be reported, but excluded from the compliance evaluation (as described above). Additional contingencies that occur after one minute of the start of a Reportable Disturbance but end prior to the end of the Disturbance Recovery Period can be excluded from evaluation as well. Instead, PJM can determine the DCS compliance of the initial Reportable Disturbance by performing a reasonable estimation of the response that would have occurred had the second and subsequent contingencies not occurred.



Attachment E: PJM REPORTING OF NERC BAL Standard

Daily Data Support for BAL-005 and BAL-001 reporting

PJM data archive stores the following data to support Compliance Monitoring. This data is stored for thirteen months along with quality code.

PJM Frequency BIAS development method -

PJM uses the method as described by BAL-003 R5 –

In the month of December the PJM Performance department obtains the latest published peak load forecast for PJM RTO as developed by the PJM Load Analysis subcommittee for the PJM RTO coincident peak. As specified in the requirement PJM calculates the bias by using 1.0% of this load value as the frequency bias to be used by PJM RTO for the upcoming year which meets the R5 requirement. The new bias is reported to NERC and RFC for reporting purposes. Upon approval of the NERC subcommittee the new bias is put in place via input into the EMS system and additional reporting systems as required.

PJM real time bias review

PJM Performance department reviews on an ad hoc basis the PJM bias contribution for the past year to help benchmark the system response using the distributed list of Eastern Interconnection events to study PJM performance with bias response.

PJM RTO ACE Instantaneous (scan rate no less than 4 second scan)

PJM RTO system frequency Instantaneous sampled at two second rate

PJM RTO Scheduled frequency as set in the PJM EMS control system

PJM Net Actual Interchange sampled at scan rate for ACE development

PJM RTO Net Schedule Interchange sampled at scan rate for ACE development

PJM calculates clock minute averages of the instantaneous data and stores the one minute averages for the following:

- ACE (one minute)
- Frequency (one minute)
- CF(compliance factor)
- CPS2

BAAL – Daily minute limit – high and low, minute values of BA ace-frequency. Daily exceedance minutes by hour, Note exceedance time for an event is a progressive number of minutes only reset if a minute a BA's ACE Frequency number is within the BAAL minute limit. An event can span an hour, a day, a month, or a year. Discrete reporting periods for a day or month may not capture the total time in exceedance for an event.

Field Trial Data provided to BRD Group



Balance Resources and Demand Standard Proof-of-Concept Field Trial
ATTACHMENT A
Field Trial Data Submittal Format

One-minute data will be provided in monthly files under the following CSV format:

BA, Date, Time, TimeZone, ACE, FreqError, FreqBias, ActFreq, SchedFreq, AQC, FQC, BAAL_Low, MinCtLow, BAAL_High, MinCtHigh <EOL>

Field Name	Description/Type
BA	5-character BA Identifier provided by BALRESSDT
Date	Date format (MM/DD/YYYY),
Time	24-hour time format (hh:mm),
TimeZone	3-character time-zone abbreviation (EST, EDT, CST, CDT, etc)
ACE (REAL)	Clock-minute average Area Control Error (MW) (data provided minimum of 1 decimal point)
FreqError (REAL)	Clock-minute average Frequency Error (Hz), (data provided minimum of three decimal points)
FreqBias (REAL)	Clock-minute average Frequency Bias (MW/0.1 Hz)
ActFreq (REAL)	Clock-minute average Actual Frequency (Hz) (data provided minimum of three decimal points)
SchedFreq (REAL)	Clock-minute average Scheduled Frequency (Hz) (data provided minimum of two decimal points)
AQC* (INTEGER)	ACE Quality Code (0=valid data, 1=bad data)
FQC* (INTEGER)	Frequency Quality Code (0=valid data, 1=bad data)
BAAL_Low** (REAL)	BAAL _{Low} (MW) (data provided minimum of 1 decimal point)
MinCtLow (INTEGER)	Count of the consecutive minutes of negative ACE < BAAL _{Low} when Frequency Error is negative.
BAAL_High** (REAL)	BAAL _{High} (MW) (data provided minimum of 1 decimal point)



MinCtHigh
(INTEGER)

Count of the consecutive minutes of positive ACE > BAAL_{High} when Frequency Error is positive.

PJM Performance Department review

Daily review of ACE inputs is performed by Performance Compliance to document any missing or invalid data quality values of ACE or frequency for final determination of CPS and BAAL reporting values.

PJM calculates via reports many variations of the minute data to obtain shift and daily CPS average values and running balances and BAAL as well as PJM corporate goals on the BAAL standards.

Monthly Reporting

Monthly summary CPS data is provided to: Reliability First Corporation via their WEB reporting tool, and SERC WEB reporting tool, and directly to NERC via email using CPS reporting form included in this section. BAAL Field trial data is emailed to the field test monitor as directed under field trial rules.

Monthly reporting of Net schedule and Net Actual by BA for On-Peak, Off-Peak, and Total net schedule is input into the SPP tool (NERC requirement and accepted NERC tool) by the 15th of the month. Monthly Data is obtained from the PJM settlements department broken down by BA and agreed based on central prevailing time per NERC standard. Note that in dealing with MISO as the Scheduling agent, a net schedule between PJM / MISO is the only level of detail supplied on a monthly basis by waiver authority from NERC. ALL Balancing Authorities within MISO agree with adjacent BAs on actual interchange only. The NERC tool tallies PJM On-Peak and Off Peak Inadvertent which is compared for agreement and recordkeeping purposes. The running balance is available thru the NERC tool.



NERC CPC Survey forms included – PJM can produce these reports and has them available for the preceding year.

NERC Control Performance Standard Survey All Interconnections							
CPS Form 1							
Region			Balancing area				
L10 -			Month -		Year -		
H.E. Central Time	CPS1			CPS2			
	CF	%	Number of Samples	Violations	Unavailable Periods		
0100			Record the total month's samples from each of the 24 hourly periods	Record the total month's CPS2 violations from each of the 24 hourly periods	Record the total month's unavailable periods from each of the 24 hourly periods		
0200							
0300							
0400							
0500							
0600							
0700							
0800							
0900							
1000							
1100							
1200							
1300							
1400							
1500							
1600							
1700							
1800							
1900							
2000							
2100							
2200							
2300							
2400							
CPS1 Month -			0	CPS2 Month -	0		0



NERC Control Performance Standard Survey - Regional Summary			
CPS Form 2			
Region:	Month:	Year:	Date:
Balancing area:		Control Performance Compliance	
		CPS1 Monthly Compliance %	CPS2 Monthly Compliance %
ID #	Name		

07/22/98

Quarterly DCS reporting – (January, April, July, and October for the previous quarter) The following data is reported: number of contingencies equal to or greater than the reporting threshold and composite percent recovery to Reliability First Corporation and to NERC along with the next quarter MW reporting threshold. Should there be any reportable DCS events greater than 15 minutes recovery time. All reportable events must be used to calculate average recovery factor – a then determine the next quarters CRAF based on the formula as found on the disturbance reporting form using this formula – recovery factor a is subtracted from 200 (⁴ [200-(a)], please round to the nearest whole percentage.)

The next quarter’s contingency reserve objective is then increased by the CRAF.



NERC Disturbance Control Standard Report

Quarter:	1	Disturbances Not Greater than the Most Severe Single Contingency Loss	Disturbances Greater than the Most Severe Single Contingency Loss ³		This Quarter's CRAF ⁴	Criteria for Determining Reportable Disturbances This Report	Criteria for Determining Reportable Disturbances Next Report	
	Year:		2004	Number				APR
Region:	NPCC	Number	APR ² (a)	Number	APR			
Balancing area/RSG ¹ :			100.00	0	100.00	100.00	0.80	80%

¹ When reporting as a Reserve Sharing Group (RSG), submit data for the entire group only and list the Balancing areas comprising the RSG.



NERC Disturbance Control Standard Report

² APR indicates the Average Percent Recovery.

³ Not a performance measure. For informational purposes only.

⁴ [200-(a)], please round to the nearest whole percentage.

A Balancing area or Reserve Sharing Group must increase their Contingency Reserve Requirement by the CRAF. CRR changes are implemented one month after the end of a reporting quarter and remain in effect for three months.

Frequency Survey Form

PJM upon request from NERC or RFC and hourly Frequency Survey is filled out following the NERC Frequency Response Characteristic Survey as documented below – part of the NERC Operating Manual under Frequency Response training document.

Frequency Response Characteristic Surveys will be conducted to compare each CONTROL AREA'S FRC with respect to its bias setting.

1. Issuance of Survey

Surveys will be conducted for periods selected by the chairman or vice chairman of the Resources Subcommittee or designee, on the chairman's or vice chairman's own motion, or in response to specific requests from members of the Subcommittee.

- As soon as possible after the survey period is chosen by the chairman, the chairman or vice chairman shall notify each appropriate Subcommittee member by letter of the survey date and time, the frequency points A, B, and C, frequency deviation, and date for the survey to be returned.
- Each Subcommittee member shall notify each reporting CONTROL AREA within the Region by written request. The Subcommittee member shall provide each CONTROL AREA a copy of the survey form "NERC Frequency Response Characteristic Survey."
- Each reporting control area shall return one completed copy of the survey form and a copy of its frequency chart.
- Each Subcommittee member shall review the appropriate control area results and send the copies of survey form results to the NERC staff.
- The NERC staff shall combine the control area data into one report and send one copy to each Subcommittee member.
- Each Subcommittee member shall be responsible for reproducing and distributing the summary report within their Region.

2. Instructions for FRC Survey

The table is the Control Area Frequency Response Characteristic Survey form.

A sample frequency chart is shown in Figure 1 with points A, B, and C labeled. Point A represents the interconnected system frequency immediately before the disturbance. Point B represents the interconnected system frequency at the point immediately after the frequency stabilizes due to governor action but before the contingent control area takes corrective AGC action. Point C represents the interconnected system frequency at its maximum deviation due to the loss of rotating kinetic energy from the turbine generators.

Line-by-line instructions for the survey form follow:

- Line 1: Enter the date and time of survey period (this information is provided by the RESOURCES SUBCOMMITTEE member's survey request) and the name of the control area.

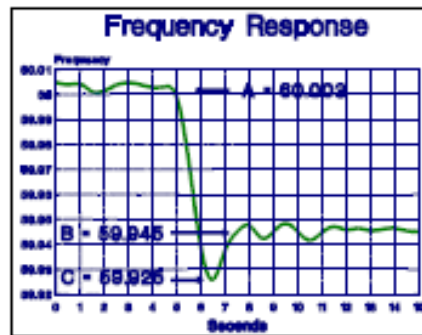



B. Survey Procedures

- Line 2: Enter the net interchange of the control area immediately before the survey period (corresponding to Point A). Sign convention for net power into a CONTROL AREA is negative (-), and net power out of a control area is positive (+).
- Line 3: Enter the net interchange of the control area immediately after the survey period (corresponding to Point B). Use the same sign convention as Line 2.
- A
- Line 4: Enter the change in net interchange of the CONTROL AREA. Line 4 = Line 3 – Line 2. For a disturbance that causes the frequency to decrease, this value should be positive except for the contingent CONTROL AREA, in which case it is negative.
- Line 5: If the control area completing the survey suffered the loss, enter the load or generation lost by the control area. Otherwise, leave this line blank. Sign convention for generation loss is negative (-) and for load loss is positive (+).
- Line 6: Enter the control area response. This value is (Line 4 – Line 5).
- Line 7: Enter the change in interconnected system frequency as specified in the letter of transmittal.
- Line 8: Enter the frequency response characteristic of the CONTROL AREA based on the change in interconnected system frequency. This value is:

$$FRC = \frac{Line6}{(Line7)10.0}$$

(The factor of 10.0 is used to change the units to MW/0.1 Hz.) This value approximates the frequency response of the control area for this disturbance.

- Line 9: Enter the frequency bias setting of the CONTROL AREA.
- Line 10: Enter the CONTROL AREA's net system load immediately before the disturbance.
- Line 11: Enter the CONTROL AREA's total capacity synchronized to the INTERCONNECTION immediately before the disturbance. Jointly owned units should be reported in their entirety by the CONTROL AREA in which they are located.

Lines 12, 13, and 14:

Enter the frequency values you observed from the frequency chart for Points A, B, and C, respectively.

Survey will be submitted to the Region and NERC for review by the committee representatives along with the compiling of report data.



1.		Hr. Ending (CST)	Control Area:						Region:	
AREA INTERCHANGE DETAILS (All values in MWh)										
2.	Control Area(s) (Who) (Adjacent Control Areas Only)								Total	
3.	Actual Interchange (Including After-The-Fact Pseudo-Ties)									
4.	Scheduled Interchange (Including After-The-Fact Dynamic Schedules)									
5.	Scheduled Inadvertent Payback									
6.	Inadvertent Interchange (Line 3 - Line 4 - Line 5)									
AREA INTERCHANGE CALCULATION										
7.	Computed Frequency Error (Ave. Freq. - Scheduled Freq.)		Hz (Provided by Time Monitor)							
8.	Frequency Bias Setting		MW/0.1 Hz (negative value)							
9.	Frequency Bias Obligation		MWh Line 7 x Line 8 x 10.0							
10.	Unilateral Inadvertent Payback		MWh							
11.	Adjusted Area Interchange Error		MWh Line 6 Total - Line 9 - Line 10							
			1	2	3	4	5	6	Total	Avg
12.	Integrate ACE for the 6 consecutive periods of the CSP2 compliance (or best guess, visual, estimate or average ACE for each 10 minute period). →	:00-:10	:10-:20	:20-:30	:30-:40	:40-:50	:50-:60		Total/6	

Notes: List remarks on separate sheet of paper, including conditions causing regulating errors. Net power delivered out of a control area (overgeneration) is positive (+). Net power received into a control area (undergeneration) is negative (-).



AIE Survey Form –

PJM upon request from NERC or RFC and hourly Area Interchange Error Survey is filled out containing information as listed below.

Requestor determines the Date and Hour(s) and supplied the Frequency Error. PJM will supply the six ten minute samples compute the total ACE, Average ACE, Adjusted AIE and provide the L10 and frequency Bias as used in the system. Compute the Control Error as a percentage of L10. Sample AIE report below – forms sent to BA by requestor.

NERC Resources Subcommittee
Area Interchange Error Survey
Six 10-minute ACE Values - by Region
Eastern Interconnection

DRAFT

Control Area Name	Period 1	Period 2	Period 3	Period 4	Period 5	Period 6	Total ACE	Average ACE	Adj. AIE	L10	Freq. Bias	Control Error (% of Lsub10)
Survey Date: Thursday, August 14, 2003												
Hour Ending: 1000 CDT												
Frequency Error: -0.0097 Hz												
ECAR												
AESC, LLC - AEBN	0.0	0.0	0.0	-1.0	0.0	0.0	-1.0	-0.17	-0.2	10.6	-2.0	0
AEP Service Corp. -- Transmission Syste	-79.6	55.6	-46.5	-85.2	-43.0	-13.7	-212.2	-35.37	-52.6	108.7	-212.0	16
AESC, LLC - Wheatland CIN	-1.0	-1.0	-1.0	-2.0	-1.0	-1.0	-7.0	-1.17	-0.5	16.9	-5.1	-4
AESC, LLC - Wheatland IPL	0.0	0.0	0.0	0.0	0.0	0.0	0.0	0.00	-0.5	16.9	-5.1	3
Big Rivers Electric Corp.	-15.1	-2.5	3.2	4.2	-4.8	-10.0	-25.0	-4.17	-0.6	22.9	-16.0	-12
Cinergy Corporation	50.4	1.7	-57.2	-23.3	-35.7	19.1	-45.0	-7.50	-28.1	83.5	-125.0	25
DECA, LLC - DELO	-3.0	-1.0	6.0	0.0	3.0	19.0	24.0	4.00	-1.2	26.3	-12.4	20
DECA, LLC - Vermillion	0.0	0.0	0.0	0.0	0.0	0.0	0.0	0.00	-0.6	18.9	-6.4	3
DECA, LLC - Washington	-22.0	-7.0	5.0	4.0	5.0	6.0	-9.0	-1.50	-3.6	18.9	-6.2	11
Duquesne Light	-28.5	-1.6	-42.8	-34.0	6.9	9.9	-90.2	-15.04	-13.8	44.8	-36.0	-3
Dayton Power & Light	24.8	55.0	31.9	-0.4	6.3	-19.0	98.6	16.44	18.6	44.2	-35.0	-5
East Kentucky Power Cooperative, Inc.	-28.4	-41.6	-60.3	-42.8	20.5	14.4	-138.2	-23.03	-53.0	41.6	-31.0	96
First Energy Corp.	-16.0	-20.0	-84.0	78.0	-59.0	-58.0	-159.0	-26.50	-73.2	90.2	-146.0	52
Hoosier Energy	-28.7	-38.4	7.8	-0.5	0.3	-2.5	-62.0	-10.33	-11.0	34.2	-21.0	2
Indianapolis Power & Light Company	15.5	-4.0	-9.0	-27.0	-29.0	-29.0	-82.5	-13.75	-14.6	45.4	-37.0	2
LG&E Energy Transmission Services	6.0	-45.0	-98.0	-147.0	0.0	-2.0	-286.0	-47.67	-44.2	72.8	-95.0	-5
Michigan Electric Coordinated System	130.9	203.4	42.4	-10.6	-94.3	-0.3	271.6	45.27	-15.7	111.7	-224.0	55
Northern Indiana Public Service Company	74.0	40.0	-7.0	-1.0	-8.0	5.0	103.0	17.17	15.3	57.3	-59.0	3
Ohio Valley Electric Corporation	-7.5	-11.2	-11.4	-13.6	-6.6	-0.4	-50.7	-8.45	-2.9	40.9	-30.0	-14
Southern Indiana Gas & Electric Co.	-68.8	-75.0	-88.9	-50.3	-78.8	-46.2	-407.9	-67.99	-56.7	39.7	-28.3	-28



PJM Manual 12 Revision History

Revision 24 (04/03/2012):

- Attachment B: Updated language regarding PJM issuing PCLLRWs for non-market facilities. Added language regarding post-contingency low voltage PCLLRWs.

Revision 23 (11/16/2011):

- Attachment A: Added note for clarity on IRC calculations. Need to reflect regulation assignments.
- Attachment B: Updated language regarding PJM issuing PCLLRWs for non-market facilities.
- Section 4.6.17: Remove this section completely to incorporate into M-27.
- Section 4.6.15: Remove responsibility for GO to send blackstart test results to LCC.
- Throughout: Update UDS and LAUDS to RT-SCED and IT-SCED, respectively.
- Throughout: Update UDS and LAUDS to RT-SCED and IT-SCED, respectively.

Revision 22 (05/13/2011):

- Attachment A: Updated to reflect June 2010 changes to IRC reporting.

Revision 21 (10/01/2010):

- Attachment B: Transmission Constraint Control Guidelines: Replaced existing note box in section B.2 Generation Redispatch to reflect revision to PJM tariff regarding energy resource curtailments (Docket #ER10-1762-000).

Revision 20 (10/05/2009):

- Annual Review of Manual 12

Revision 19 (06/30/2009):

- Section 4 - Revision included throughout manual to consolidate references and language related to black start resources
- Section 4 – New language to outline NERC standards cost recovery guidelines.
- Made updates to reserves section of Section 4 – changes secondary to supplemental
- Added language to Attachment B for wind operations / curtailments

Revision 18 (07/02/2008)

- Version to correct real-time controlling actions for BES non-market facilities.

Revision 17 (07/01/2008)

- Section 5: Transmission Facility Control - Defined Generation Redispatch procedures for Market versus Non-Market facilities

- Attachment B: Transmission Constraint Control Guidelines – Defined Generation Redispatch procedures for Market versus Non-Market facilities.

Revision 16 (11/01/2007)

- Clarified language for synchronized reserves to include implementing upon the contingent loss of generation equal to 80% or more of its most severe single contingency.
- Added clarification language on black start testing.

Revision 15 (05/15/2007)

- **General:** Changed references from Control Center Requirements Manual / Dispatching Operations Manual to Control Center and Data Exchange Manual / Balancing Operations Manual.
- **Section 2:** Added references to EMS alarms generated
- **Section 3:** Provided additional detail for PJM's ACE calculation and compliance monitoring and reporting efforts performed by Performance Compliance Department. Also relocated Manual 11, Section 7, "External Transaction Scheduling" to this section (PJM Member Actions). Provided clarity
- **Section 4:** Deleted all references to Automatic Reserve Sharing System for ECAR and MAIN Regions. Provided clarity on Minimum Critical Blackstart requirements, referencing PJM System Restoration Manual, Attachment A: Minimum Critical Black Start Requirement.
- **Section 5:** Modified Exhibit 17. Deleted Voltage Coordination Plan.
- **Section 7:** Relocated this section to Manual 12, Section 3, "System Control"
- **Attachment H:** Added PJM reporting of NERC BAL standard
- **Throughout:** Added references to applicable NERC standards
- **Throughout:** Renamed the manual from Dispatching Operations to Balancing Operations and then changed all "dispatching operations" to "balancing operations" within the manual

Revision 14 (03/01/2007)

- Section 3: (System Control) Modified to clarify the information supplied during dispatch operations.
- Section 4: Providing Ancillary Services—Revised to clarify existing PJM black start business procedures and testing requirements for better alignment with RFC standards.
- Attachment B: (Transmission Constraint Control Guidelines) Modified to clarify the procedures for Generation Redispatch



- Attachment C: PJM Black Start Test Report Form—Revised in line with black start testing requirement changes in Section 4 for better alignment with RFC standards.
- Introduction trimmed to eliminate redundant information.
- List of PJM Manuals exhibit removed, with directions given to PJM Web site where all the manuals can be found. All other exhibits renumbered.
- Revision History permanently moved to the end of the manual.

Revision 13 (5/26/06)

Revised to reflect changes including demand participation in Ancillary Service Markets, modifications to IRC, common Regulation Market, and Dispatching tools.

Revision 12 (08/16/05)

Section 4: (Providing Ancillary Services)

Revised to reflect recent changes to Black Start Service Business Processes

Included new Attachment C: PJM Black Start Test Report Form

Included new Attachment D: PJM Auto Load Reject Test Report Form

Included new Attachment E: PJM Black Start Formulaic Cost Data Form

Included new Attachment F: PJM Black Start Actual Cost Data Form

Revision 11 (01/01/05)

Sections 1, 2, 3, 5

Revised to reflect operations based on the integration of ComEd, AEP, Dayton Power and Light, Duquesne Light, and Dominion

Revision 10 (01/01/04)

Section 4 (Providing Ancillary Service)

Revised to reflect the regulation limit relationships.

Replaced Exhibit 1 with an updated list of PJM Manuals.

Revision 09 (12/01/02)

Revised Section 4: Providing Ancillary Services

Incorporated the procedures that the PJM follows to ensure and monitor Black Start Service.

Revision 08 (04/01/02)

Section 1: Overview

Incorporated PJM West / West duties.

Section 2: Dispatching Tools



Incorporated UDS, EES, eData, SCIS, Emergency Procedure Posting Application, All-call software, and Satellite Phones. Removed Accounting Information section and exhibit.

Section 3: System Control

Included reassigning regulation while on Analog Control, Updated Time Error Correction procedure.

Section 4: Providing Ancillary Services

Incorporation of eDart reporting, implementation of Shared Reserves for DCS events, ARS (PJM West), and Regulation Requirement (PJM West).

Section 5: Transmission Facility Control

Clarification of participant duties (Transmission / Generation).

Attachment A: Instantaneous Reserve Check

Removal of company names.

Attachment B: Voltage Control

Attachment Eliminated.

Revision 07 (05/22/01)

Revised to reflect implementation of PJM Regulation Market.

Removed Attachment A: Definitions & Abbreviations. Attachment A is being developed into a 'new' PJM Manual for **Definitions and Abbreviations (M-35)**.

Removed Attachment B: Three-Point Curve Utilization.

Renamed Attachment C: PJM Instantaneous Reserve Check and Attachment D: Voltage Control, to Attachment A and Attachment B, respectively.

Revision 06 (06/01/00)

Section 04: Providing Ancillary Services

Revised subsection *Regulation* to reflect changes required to implement the PJM Regulation Market on June 1, 2000.

Attachment E: Process Diagrams

Removed to reflect changes required to implement the PJM Regulation Market on June 1, 2000.

Revision 05 (04/01/00)

Section 05: Transmission Facility Control

Removed reference to Maximum Scheduled Generation within subsections: Corrective Control Strategies, Reactive Limitation Control, and NERC Transmission Loading Relief (TLR) Procedure.

Revision 04 (06/03/99)

Section 02: Dispatching Tools



Moved *Generation Control System* from Mainframe Computer Applications section to PC Applications section. Removed *System Security*, *Megawatt Monitor*, and *Marginal Scheduler* from Mainframe Computer Applications section. Added *Network Analysis and SCADA Programs* and *Resource Scheduling and Commitment* to, and removed *Transmission Security System (TSS)* and *Future TSS* from, the PC Applications section. All these changes made to reflect installation of the new Siemens Energy Management System (EMS).

Changed all references to General Agreement on Parallel Paths (GAPP) to Interchange Distribution Calculator (IDC) to reflect new NERC application.

Modified section on *Dynamic Mapboard* to reflect the fact that it is now driven by the new Siemens computer.

Section 05: Transmission Facility Control

Added information concerning PJM implementation of the NERC Transmission Loading Relief (TLR) Procedure.

Revision 03 (04/01/98)

Section 02: Dispatching Tools

Revised Exhibit 2.1 to reference "Locational Marginal Price" rather than "Market Clearing Price."

Revision 02 (01/01/98)

Section 04: Providing Ancillary Services

Changed "The Regulating Requirement for the PJM RTO is 1.1% of the forecast peak load during On-Peak Periods (from 0500-2359 hours) and 1.1% of the forecast valley during Off-Peak Periods load (from 0000-0459 hours)." from "The Regulating Requirement for the PJM RTO is 1.1% of the forecast peak load during On-Peak Periods (from 0700-2259 hours) and 1.1% of the forecast valley during Off-Peak Periods load (2300-0659 hours)." under "Obligations & Requirements" of "Regulation."

Changed equation:

$$\text{LSEs Regulation Obligation} = (\text{LSEs Load Allocation Percentage} * \text{PJM Regulation Requirement}) \\ - \text{LSEs Share of Joint - Owned Unit Regulation}$$

from:

$$\text{LSEs Regulation Obligation} = (\text{LSEs Load Allocation Percentage} * \text{PJM Regulation Requirement}) \\ - \text{LSEs Share of Keystone and Conemaugh Regulation}$$

under "Determining Regulation Assignment" of "Regulation."

Changed "During On-Peak Periods (0500 hours to 2359 hours), the PJM Regulating Requirement is 1.1 % of the PJM RTO's peak load forecast, as determined prior to 0430 hours" from "During On-Peak Periods (0700 hours to 2259 hours), the PJM Regulating Requirement is 1.1 % of the PJM RTO's peak load forecast, as determined prior to 0630 hours" under "Obligations & Requirements" of "Regulation."



Changed “During Off-Peak Periods (0000 hours to 0459 hours), the PJM Regulating Requirement is 1.1 % of the PJM RTO’s valley load forecast, as determined prior to 2330.” from “During Off-Peak Periods (2300 hours to 0659 hours), the PJM Regulating Requirement is 1.1 % of the PJM RTO’s valley load forecast, as determined prior to 2230.” under “Obligations & Requirements” of “Regulation.”

Changed “Prior to 0430 and 2330 each day, the PJM dispatcher provides the following information to the Local Control Centers for the LSEs, via the PJM ALL-CALL:

- PJM forecasted peak load and the PJM forecasted valley load for 0430 and 2330, respectively”

from “Prior to 0630 and 2230 each day, PJM dispatcher provides the following information to the Local Control Centers for the LSEs, via the PJM ALL-CALL:

- PJM forecasted peak load and the PJM forecasted valley load for 0630 and 2230, respectively”

under “Obligations & Requirements” of “Regulation.”

Changed “Scheduled MW of Joint-Owned Unit Regulation” from “Scheduled MW of joint-owned Regulation for Keystone and Conemaugh Stations” under “Determining Regulation Assignment” of “Regulation.”

Changed “The LSE decides the method of meeting its Regulation Obligation, subsequent to the PJM ALL-CALL notification but no later than 0430 or 2330 for On-Peak and Off-Peak Periods, respectively; the LSE dispatcher reports to PJM the MWs of Regulation by class to meet the LSE’s Regulation objective, plus the amount (MW) of any additional Regulation by class which is presently available to regulate.” from “The LSE decides the method of meeting its Regulation Obligation, subsequent to the PJM ALL-CALL notification but no later than 0630 or 2230 for On-Peak and Off-Peak Periods, respectively; the LSE dispatcher reports to PJM the MWs of Regulation by class to meet the LSE’s Regulation objective, plus the amount (MW) of any additional Regulation by class which is presently available to regulate.” under “Determining Regulation Assignment” of “Regulation.”

Attachment E: Process Diagrams

Added “Attachment E: Process Diagrams”

Revision 01 (07/08/97)

Section 2: Dispatching Tools

Added “Note: In Exhibit 2.1, **Congestion Payment Status** and **Participant Paying Congestion** Data Fields are required for transactions utilizing the option of non-firm transmission service willing to pay congestion which were scheduled and approved prior to June 28, 1997” under “Accounting Information.”

Section 5: Transmission Facility Control

Deleted “...and for non-firm transactions willing to pay congestion” from Exhibit 5.2 note under “Corrective Control Strategies.”

Revision 00 (04/30/97)



Changed references from PJM Interconnection Association to PJM Interconnection, L.L.C.

Changed references from PJM to PJM where appropriate.

Changed references from PJM to PJM RTO where appropriate.

Changed references from PJM IA to PJM.

Changed references from IA to PJM.

Changed references from Mid-Atlantic Market to PJM Interchange Energy Market.

Changed references from Mid-Atlantic Market Operations Agreement to Operating Agreement of PJM Interconnection, L.L.C.

Revision 00 (03/24/97)

This revision is a draft of the PJM Manual for ***Balancing Operations***.