



Working to Perfect the Flow of Energy

Style Definition: PJM_Bulleted_Outline_1

Style Definition: PJM_Normal

PJM Manual 3A:
Energy Management
System (EMS) Model
Updates and Quality
Assurance (QA)

Revision: [87](#)

Effective Date: [07/12/2013](#)

Prepared by:
Operation Support Division

© PJM 2013



PJM Manual 3A:

EMS Model Updates and QA Manual

Table of Contents

Table of Contents ii

Table of Exhibits iv

Approval 1

Current Revision..... 1

Introduction..... 32

 ABOUT PJM MANUALS 32

 ABOUT THIS MANUAL 32

Intended Audience 32

References..... 42

 USING THIS MANUAL 43

What You Will Find In This Manual..... 43

Section 1: General Requirements..... 54

 1.1 OVERVIEW 54

 1.2 ELECTRICAL MODEL RESPONSIBILITIES FOR GENERATOR OWNER’S OPERATING ENTITY 65

 1.3 ELECTRICAL MODEL RESPONSIBILITIES FOR TRANSMISSION OWNER’S OPERATING ENTITY

 65

 1.4 TRANSMISSION OPERATING GUIDELINES AND SYSTEM LIMITS..... 76

 1.5 PJM’S REAL-TIME RELIABILITY MODEL 87

 1.6 REAL-TIME TELEMETRY DATA REQUIREMENTS FOR SYSTEM RELIABILITY 109

 1.7 PJM’S REAL-TIME TRANSIENT STABILITY MODEL 1140

Section 2: Model Information and Transmission Facility Requirements 1211

 2.1 OVERVIEW 1211

 2.2 MODEL INFORMATION AND DATA REQUIREMENTS..... 1312

 2.3 PJM BULK ELECTRIC SYSTEM* TRANSMISSION FACILITIES 1513

 2.4 PJM CONGESTION MANAGEMENT FACILITIES..... 1513

 2.4.1 *Telemetry Requirements for Facilities to be added to Congestion Management Control*

 1514

 2.4.2 *Process to Change the PJM Congestion Management Control Facilities List* 1614

 2.4.3 *Process to change Post Contingency Congestion Management Facilities* 1816

Section 3: EMS Data Collection Process 1918

 3.1 BACKGROUND ON PJM EMS SYSTEM MODEL UPDATES..... 1918

 3.2 PJM TRANSMISSION SYSTEM MODEL UPDATE/DATA COLLECTION PROCEDURES..... 2019

 3.3 PJM RATINGS DATA (THERMAL EQUIPMENT RATINGS MONITOR – TERM)..... 2826

 3.4 INTERIM UPDATE CAPABILITY 2826

 3.5 NAMING CONVENTIONS 2826

Section 4: EMS Model Change Control and Feedback..... 3028

 4.1 OVERVIEW OF EMS MODEL CHANGE CONTROL AND FEEDBACK 3028

 4.2 BUS CONNECTIVITY AND ENGINEERING DATA..... 3229

 4.3 SUBSTATION NODAL CONNECTIVITY 3230

 4.4 PROCESSING TIE-LINES..... 3432

 4.5 CUT-INS AND CONTINGENCIES 3533

 4.6 SCADA MAPPING 4038



4.7 ONE-LINE LIFE CYCLE	4038
4.8 DATA MANAGEMENT SUBCOMMITTEE.....	4139
Section 5: Real-Time Application Support	4240
5.1 OVERVIEW OF REAL-TIME APPLICATION SUPPORT	4240
5.1.1 <i>Real-Time Analysis</i>	4240
5.1.2 <i>SE Solution Quality and Availability, including Links</i>	4344
5.1.3 <i>Contingency Analysis (CA)</i>	4442
5.1.4 <i>CA Solution Quality</i>	4542
Section 6: Data Interfaces.....	4744
Section 7: Model Contacts.....	4845
Appendix A: TERM Processing Ratings Data Check List.....	4946
Appendix B: eDART Network Model Training	5653
Appendix C: Bulk Electric System (BES) Definition Implementation at PJM	5754
Revision History	6259



Table of Exhibits

EXHIBIT 1: PJM EMS THREE (3) LAYER MODEL..... 98
EXHIBIT 2: DEADLINES FOR SUBMITTING MODELING DATA..... 2120
EXHIBIT 3: TIMELINE FOR MODEL UPDATE—SAMPLE..... 2224
EXHIBIT 4: PJM EMS MODEL DETAILS 2725
EXHIBIT 5: SAMPLE MODEL UPDATE BUILD SUMMARY 3129
EXHIBIT 6 ONE-LINE DIAGRAM SYMBOLS 3334
EXHIBIT 7 - EDART NETWORK MODEL DATA SUBMISSION & MODEL VALIDATION TIMELINE..... 3432
EXHIBIT 8 - MODEL SUBMISSION, BUILD, QUALITY ASSURANCE REVIEW AND CUT-IN TIMELINE
..... 3634
EXHIBIT 9 - EDART OUTAGE TICKET WITH CUT-IN FLAG..... 3735
EXHIBIT 10 - DUMMY SWITCHES TO MODEL NEW FACILITIES PRE- AND POST-CONSTRUCTION. 3836
EXHIBIT 11 - SAMPLE 6 WEEK LOOK AHEAD CUT-IN REPORT..... 3937



Approval

Approval Date: 7/12/2013
Effective Date: 7/12/2013

~~Ron DeLoach~~ John Baranowski, Manager
Model Management Department

Current Revision

Revision 08 (09/24/2013) DATE:

- Model Management Manager & Manual Owner changed to Ron DeLoach
- Updated Exhibit 4 to include EKPC in detailed, SE model
- Revised sections 4.1 to note that a PJM will make a detailed, preliminary model difference report available to TOs with admonition to use with caution
- Revised section 5.1.2 to include model validation and benchmark tests incorporated in response to FERC Audit Recommendation 13
- Added another sub-section to Appendix A: Processing Ratings in Short Notice, Emergency Situations
- Modified Appendix C: Bulk Electric System (BES) Definition Implementation at PJM to accommodate new NERC definition

Formatted: Bulleted + Level: 1 + Aligned at: 0.75" + Indent at: 1"

Revision 07 (07/10/2013):

- Engineering Support to Model Management, John Baranowski, mgr
- Responsibility for ratings to Real Time Data Management, Chris Smart, mgr
- References from DMWG to DMS
- Numerous edits throughout the entire document for clarity
- Section 1.2, specifies auxiliary loads, generator step-ups & telemetry model requirements to support BES
- Inserted new section 1.7 discussing TSA and data requirements
- Section 2.2 & 3.1 added references to transient stability data requirements including contingency definitions and clearing times in sections involving data requirements
- Section 3.3 defines emergency ratings as capability up to 4 hours and emergency ratings as capability up to 15 minutes
- Section 3.3 eliminated statement that 3% separation is required between emergency & load dump

Formatted: PJM_Bulleted_Outline_1



- ~~Added new Exhibit 5 illustrating the level of model detail in the overall PJM EMS model~~
- ~~Added Solar Park to generator naming conventions in Section 3.5~~
- ~~Provided reference locations for LMP and FTR load flow data in section 4.2 Bus Connectivity and Engineering Data~~
- ~~Inserted new section 4.4 explaining Tie line cut-in process requirements~~
- ~~Section 4.5 (was 4.4) revised to describe Cut-in flags & reports~~
- ~~Section 5.1 removed references to theory and reality~~
- ~~Section 5.1.2 clarified to state that PJM's SE solution & dumps are provided to TOs upon request~~
- ~~In Appendix A, TERM Processing Data Ratings Check List removed references to forced differentials between Normal, Emergency and Load Dump ratings (see Section 3.3 changes)~~



Introduction

Welcome to the PJM Manual for **Energy Management Systems Model Updates and Quality Assurance**. In this Introduction you will find information:

- What you can expect from the PJM Manuals (see “About PJM Manuals”).
- What you can expect from this PJM Manual (see “About This Manual”).
- How to use this manual (see “Using This Manual”).

About PJM Manuals

The PJM Manuals are the instructions, rules, procedures, and guidelines established by PJM for the operation, planning, and accounting requirements of the PJM and the PJM Energy Market. The manuals are grouped under the following categories:

- Transmission
- PJM Energy Market
- Generation and transmission interconnection
- Reserve
- Accounting and Billing
- PJM Administrative Services
- For a complete list of all PJM Manuals, go to www.pjm.com and select “Manuals” under the “Documents” pull-down menu.

About This Manual

The **PJM Manual for Energy Management System Model Updates and Quality Assurance** is one of a series of manuals within the Transmission set. This manual focuses on specific process and procedures for the updating and verifying the PJM EMS model.

The **PJM Manual for Energy Management System Model Updates and Quality Assurance** consists of 7 sections. These sections are listed in the table of contents beginning on page ii.

Intended Audience

The Intended audiences for the **PJM Manual for Energy Management System Model Updates and Quality Assurance** are:

- PJM dispatchers
- PJM operations staff
- Transmission Owners
- PJM model / equipment owners



References

There are several reference documents that provide both background and detail. The ***PJM Manual for Energy Management System Model Updates and Quality Assurance*** does not replace any of the information in these reference documents. These documents are the primary source for specific requirements and implementation details. The references to the ***PJM Manual for Energy Management System Model Updates and Quality Assurance*** are:

- Transmission Owners Agreement
- Transmission Use Agreement
- ORNS Terminal Operating Manual
- EMS Users Manual
- PJM Manual for Control Center and Data Exchange Manual (M-1)
- PJM Manual for Transmission Service Requests (M-2)
- PJM Manual for Transmission Operations (M-3)
- PJM Manual for Balancing Operations (M-12)
- PJM Manual for Emergency Operations (M-13)
- PJM Manual for Generator Operational Requirements (M-14D)

Using This Manual

We believe that explaining concepts is just as important as presenting procedures. This philosophy is reflected in the way we organize the material in this manual. We start each section with an overview. Then we present details, procedures or references to procedures found in other PJM manuals. The following provides an orientation to the manual's structure.

What You Will Find In This Manual

- A table of contents that lists two levels of subheadings within each of the sections
- An approval page that lists the required approvals and a brief outline of the current revision
- Sections containing the specific guidelines, requirements, or procedures including PJM actions and PJM Member actions
- List of terms used in PJM Manual
- A section at the end detailing all previous revisions of this PJM Manual



Section 1: General Requirements

Welcome to the Requirements section of the ***PJM Manual for Energy Management System Model Updates and Quality***. In this section you will find the following information:

- An overview of the general services provided by PJM (see “Overview”)
- An overview of Electrical Model Responsibilities for Transmission Owner’s Operating Entity
- An overview of Transmission Operating Guidelines and System Limits
- A description of PJM’s Real-Time Reliability Model (see “PJM’s Real-Time Reliability Model”)

1.1 Overview

- PJM is the regional Reliability Coordinator for the PJM RTO and is responsible for all regional reliability coordination as defined in the NERC Reliability Standards, along with the ***ReliabilityFirst*** and ***SERC*** Reliability Standards and applicable PJM Operating Manuals.

PJM operates the transmission grid in compliance with good utility practice, applicable standards, policies, guidelines and operating procedures, including, but not limited to:

- The PJM Transmission Operations Manual (M3)
- NERC Reliability Standards
- ***ReliabilityFirst*** Reliability Standards
- ***SERC*** Reliability Standards
- Individual Transmission Owners Operating Procedures submitted to PJM to identify specific operating problems that could affect operation of the interconnected PJM as references during normal and emergency operations of the PJM transmission grid.

In addition to facilities defined by the ***ReliabilityFirst Corporation*** and ***SERC Reliability Corporation*** definition of the Bulk Electric System, PJM also includes all electric facilities defined as part of PJM’s Congestion Management (aka Reliability & Markets) program, as well as, other facilities as required to ensure reliable and economic operation. This comprehensive set of equipment is defined as the PJM Bulk Electric System and will be referenced as the PJM Bulk System in this document.

Transmission Owners (TOs) shall operate the PJM Bulk System Facilities in accordance with the PJM Manuals and follow PJM instructions related to PJM responsibilities including, but not limited to:

- Performing the physical operation and maintenance of the PJM Bulk System Facilities
- Directing changes in the operation of transmission voltage control equipment



- Taking those additional actions required to prevent an imminent Emergency Condition or to restore the PJM transmission grid to a secure state in the event of a PJM system emergency.

1.2 Electrical Model Responsibilities for Generator Owner's Operating Entity

The PJM Generator Owner operating entities are responsible for providing engineering data such as impedances, ratings and other pertinent data required by PJM to model their equipment (e.g. generator step-up transformers and associated switches, breakers, etc.) and generator characteristics such as MW output and MVAR curves. Telemetry associated with the generating facilities is also required to support modeling efforts.

The generation owner is required to:

- Establish transmission facilities ratings and provide these ratings to PJM
- Provide local network integrity by defining operating limits, developing contingency plans and monitoring operations if applicable
- *Provide telemetry of generating units and transmission equipment to PJM and other Transmission Owners
- Provide real-time operations information to PJM and other Transmission Owners
- Provide maintenance and construction plans to PJM and other Transmission Owners as required
- *Supply engineering data for generator and transmission system models to PJM and other Transmission Owners as required (subject to proper authorizations/NDAs)
- Define contingencies to be evaluated in real-time
- Submit outage requests to PJM according to PJM requirements
- *Includes generator step-up transformers, auxiliary/station service or common service loads, etc. for BES units

1.3 Electrical Model Responsibilities for Transmission Owner's Operating Entity

The PJM Transmission Owner operating entity (or Local Control Center – LCC – Transmission Operator) responsibilities defined below are required to create and maintain an accurate model of the electric system. These models are required to analyze real time conditions to help ensure that the PJM transmission system is operated safely and reliably.

PJM Transmission Owners are obligated to provide data and information to adequately model the electric system. In addition to the responsibilities identified in this manual, the PJM TOA and the PJM manuals also reference models and information required by PJM. The roles identified by PJM are consistent with those in the NERC Functional Model for interconnected system operation. The responsibilities listed below, although not intended to be all-inclusive, identify many significant Transmission Owner operational responsibilities



and obligations which impact electric system modeling. The Transmission Owner is required to:

- Establish transmission facilities ratings and provide these ratings to PJM
- Provide local network integrity by defining operating limits, developing contingency plans and monitoring operations if applicable
- Provide telemetry of transmission systems to PJM and other Transmission Owners
- Provide real-time operations information to PJM and other Transmission Owners
- Provide maintenance and construction plans to PJM and other Transmission Owners as required
- Supply engineering data for transmission system models to PJM and other Transmission Owners as required
- Define contingencies to be evaluated in real-time
- Submit outage requests to PJM according to PJM requirements

The Transmission Owner representative assigned to the System Operations Subcommittee (SOS-T) is designated the 'owner' of EMS model information for their electrical system. Data Management Working Group members and/or other representatives designated by the SOS-T member are points of contact for coordinating model data collection and/or model problem resolution.

Note that the data and information exchanged is subject to applicable code of conduct standards.

1.4 Transmission Operating Guidelines and System Limits

PJM directs the operation of the PJM Bulk System Facilities in agreement with the NERC and **ReliabilityFirst** Reliability Standards. In doing this, PJM considers transmission constraints, restrictions, and/or limitations in the overall operation of the PJM RTO. The PJM RTO is operated such that the following limits are not violated:

- transmission facility thermal limits
- transmission facility post-contingency thermal limits where applicable (see M3 Transmission Operations at <http://www.pjm.com/documents/manuals.aspx>)
- voltage limits
- transfer limits
- stability limits

PJM operates the interconnected grid so that immediately following any single malfunction or failure, the facility loadings are within appropriate thermal limits, while maintaining an acceptable voltage profile. For details about PJM's thermal operation and voltage requirements:



- **Facility Ratings Definitions and Data Procedures** – See M03 section 2 Thermal Operating Guidelines.
- **For Voltage Limit Definitions and Data Procedures** – See M03 section 3 Voltage and Stability Operating Guidelines.

Potential malfunctions or failures, such as the sudden and unplanned loss of a generating unit, transmission line, or transformer, are called contingencies. PJM defines a contingency as a possible event resulting in the failure or malfunction of one or more PJM Bulk Electric System Facilities. Contingencies, which simulate the actions of protective relays, must be modeled to assess system security or reliability at all times. The contingencies simulate removing elements from service which are designed to minimize potential adverse system impacts.

Although the PJM RTO is operated such that limitations are not violated, it is recognized that occasionally, for various reasons, thermal limitations can be exceeded for short periods under controlled conditions without adversely impacting system reliability or damaging equipment. For example, the Constraint Management Mitigation procedures documented in Transmission Operations Manual (M3) can be used during short time switching periods when adhering to all of the requirements and parameters.

1.5 PJM's Real-Time Reliability Model

PJM's Real-Time Reliability Model, also known as the EMS model, is a computer representation of the power system facilities in the PJM RTO and other Control Areas that may impact the reliable operation of the PJM system. The model, maintained by designated PJM support staff, resides on the PJM Energy Management System (EMS). The PJM EMS Network Application (NA) programs utilize the model to:

- calculate the real-time state of the electric system; and,
- assess if the PJM system is operating within relevant, established limits

The EMS model is adapted for use in the real-time Locational Marginal Price calculator (LMP - see Section 5 of this manual, Data Interfaces). The LMP calculator is interfaced to another program, the Security Constrained Economic Dispatch (SCED) program which models PJM generators. The LMP and SCED programs work together to develop secure, economic operating points for the electric system and to provide automatic generation signals (AGC). These systems use data from various sources including, but not limited to, the EMS.

All the models are created and maintained from input data received by PJM from various sources including Transmission Owners, Generation Owners, Load Serving Entities, and other Reliability Coordinators.

For real-time reliability analysis, PJM uses a multi-layer modeling approach:

Layer 1 is the PJM Internal Footprint: A detailed model is maintained for companies within the PJM footprint (i.e., companies for which PJM serves as NERC Reliability Coordinator). The models are complete with breakers and switches, lines, transformers, etc., along with supporting real-time telemetry. PJM's first priority is to maintain accurate, detailed models of internal systems. As noted in the overview section, PJM's EMS models all elements of the Bulk Electric System as defined by **ReliabilityFirst Corporation** and **SERC Reliability**



Corporation (generally all 100+ kV circuits except single feed radial circuits: transformers with two or more terminals at 100+ kV: and, generator step-ups for units greater than 20 MW connected to the 100+ kV system). In addition, PJM's EMS also models lower voltage elements of the power system, especially if the lower voltage elements serve as parallel underlying circuitry.

Layer 2 uses similarly detailed information (including telemetry) that is generally available for systems adjacent to Layer 1. These systems, particularly the high voltage portions of these systems, are 'electrically close' to PJM. In part to facilitate modeling, PJM has established, or is working to establish, Joint Operating Agreements (JOAs), with adjacent Reliability Coordinators. Among other things, these agreements facilitate exchange of model and telemetry data. Entities with direct electrical ties to PJM are represented in detail, particularly at the boundaries. Lower voltage portions of these systems are not generally as tightly coupled electrically as the high voltage systems and are therefore not typically modeled in great detail. These are the next most critical areas to be maintained in the model.

Layer 3 represents the effects of systems beyond adjacent systems. Since these systems are not electrically close to PJM, systems beyond the PJM Footprint and Layer 2 areas are reduced (equivalenced) and/or truncated. Consequently these systems have much less detail. The impact of Layer 3 systems on PJM will be less than electric systems which are closer and more tightly coupled. Based on the physics of the interconnected grid, it is anticipated that these areas will result in minimal impact on equipment flows within the PJM footprint.

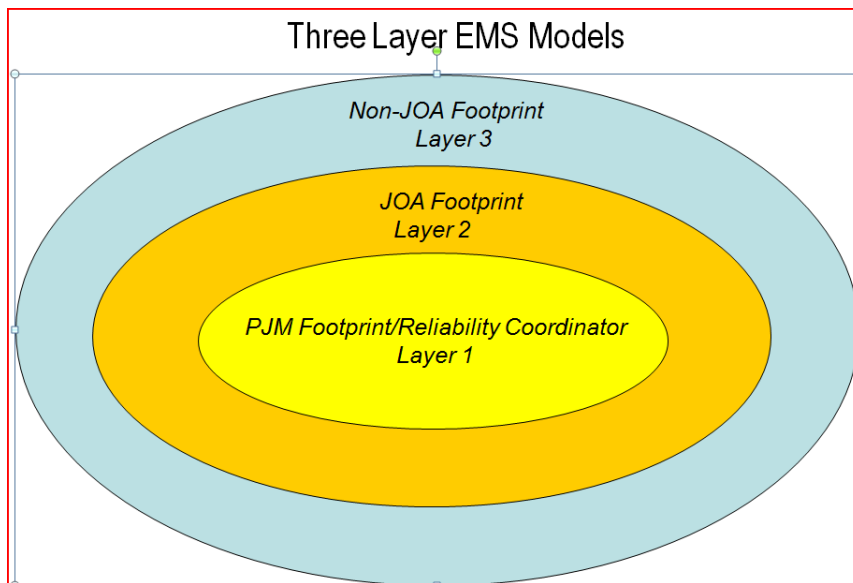

Exhibit 1: PJM EMS Three (3) Layer Model



Keeping the Steady-state Model Current

The models are only as accurate as the input data used to derive them; therefore, timely and accurate data updates are critical. These updates are performed on a regularly scheduled basis every year. Summer, Fall, Winter and Spring Builds are normally performed. The build dates are posted and can be viewed by browsing this web page: <http://www.pjm.com/Calendar.aspx> and selecting System Changes from the drop-down.

PJM relies upon TOs and GOs along with data obtained through JOAs to keep models current. It is important to note that GO information is primarily obtained from either the PJM planning queues or from PJM Interconnection Coordination staff members.

The NERC MMWG modeling effort provides basic electrical models of the Eastern Interconnection which PJM uses for regional and seasonal studies, as well as, ATC calculations. This information is not sufficient for real-time applications since MMWG cases use a bus-based approach. Additional details are needed to support real-time evaluations (e.g., breaker and/or switch status, tap positions, etc.). Real-time models also differ from MMWG models in that State Estimation requires branch flow, breaker status and voltage telemetry information which is generally available through ICCP or similar data links. Note that PJM does use MMWG data such as line impedances and basic connectivity information when necessary, especially for external system models.

Other practical considerations regarding the real-time models involve throughput and solution integrity. These qualities tend to degrade as the scope of the model grows so balancing the competing requirements is essential. It is incumbent upon PJM staff to balance the ability of the software to produce timely and reliable results with the appropriate amount of electrical detail. Consequently, PJM reserves the right to determine what level of model detail is appropriate and adequate for ALL portions of the model.

1.6 Real-Time Telemetry Data Requirements for System Reliability

PJM Manual M01 – PJM Manual for Control Center Requirements – should be used as the source for Control Center requirements. This includes, but is not necessarily limited to metering placement requirements, data acquisition frequency and accuracy requirements.

In general, Analog Data measurements are required for:

- Voltages for buses at 34 kV and above
- MW and MVAR values for all generating units greater than 1 MW (usually individual unit generation barring special, approved circumstances)
- MW and MVAR values (both ends) for designated transmission facilities (lines, transformers, phase shifters, series devices) at 69 kV and above (if single-phase metering is employed, the B-phase is preferred)
- Transformer phase angle regulator (PAR) tap positions for modeled and controlled transformers
- Transformer load tap changer (LTC or TCUL) tap positions for modeled and controlled transformers
- MVAR values for synchronous condensers
- MW & MVAR injections on buses at 34 kV and above



- Selected station frequencies

In general, Status Data is required for:

- Circuit breaker status for each modeled facility at 69 kV and above
- Breaker and disconnect statuses as modeled
- Transformer fixed tap settings (change in no-load tap setting)

1.7 PJM's Real-Time Transient Stability Model

PJM's Transient Stability Analysis (TSA) is a separate tool, largely independent of the EMS Network Analysis tools and data. TSA does use the Real-Time Reliability Model (aka EMS model) to establish positive-sequence electrical connectivity and uses the State Estimator solution to establish the initial conditions prior to performing transient analysis simulations.

To simulate transient behavior, data from PJM planning models is interfaced to the EMS model to establish appropriate generator, governor and exciter models, as well as, fault clearing times associated with protection schemes for the contingencies to be studied.

Keeping the TSA Model Current

Since models are only as accurate as the input data used to derive them, timely and accurate data updates are critical. Models and associated data will be re-synchronized annually with the information in PJM planning models. In addition, Transmission Owners are required to provide updates as needed, submitting fault-clearing time information through eDART. PJM may also request data checks or verification from TOs or GOs on an ad hoc basis.



Section 2: Model Information and Transmission Facility Requirements

Welcome to the Model Information and Transmission Facility Requirements section of the **PJM Manual for Energy Management System Model Updates and Quality Assurance**.

In this section you will find the following information:

- Model information and data requirements
- A description of PJM Transmission Facilities (see “PJM Transmission Facilities” @ <http://www.pjm.com/markets-and-operations/transmission-service/transmission-facilities.aspx>) and associated change request process. The PJM Transmission Facilities list delineates elements of the PJM Bulk Electric System as defined by NERC.
- A description of Transmission Owner facilities (see “Local Transmission Facilities”).

2.1 Overview

As discussed in Section 1: General Requirements, PJM's Real-Time Reliability Model is constructed of three (3) layers with varying levels of details. The first layer consists of the electrical systems within the PJM footprint, the second layer consists of adjacent systems and the third layer consists of systems which are judged to have minimal electrical impact on PJM.

Modeling requirements for electrical simulations depend upon the circumstances and how the results will be applied. It is important to note that the electric system is managed through a coordinated effort among several different interests. Note that RTOs such as PJM are responsible for a wide-area-view (WAV) of the Bulk Electric System (BES) while Transmission and/or Distribution System Owners are responsible for local area problems. In all cases, though, the physics of the electrical grid must be modeled to produce accurate results of actual and expected flows.

PJM's role is to identify and prevent problems which may impact interconnected systems. Consequently, PJM models must encompass transmission systems belonging to members of the organization, as well as, models of adjacent transmission systems since these systems may also impact internal flows and voltages. Within the PJM footprint PJM operators manage the system by controlling capacitors, reactors, load-tap-changing transformers, phase shifters, SVCs and generation patterns to eliminate actual and potential problems. PJM works with non-PJM companies to coordinate management of the overall electrical grid in the eastern portion of North America. PJM works with outside organizations to maintain and build models as required. This usually occurs as the result of regularly scheduled information exchange with the outside entities.

To establish the facilities which PJM will manage using all available means, including off-cost generation, a Tariff Facilities List is maintained and posted to the PJM website:

<http://www.pjm.com/markets-and-operations/transmission-service/transmission-facilities.aspx>



The list indicates PJM EMS modeling, Tariff obligations and Transmission Owner Outage Reporting responsibilities. This section describes the attributes of this facility list and how Transmission Owners can apply for amendments to the list.

Section 2 of Manual 3A concentrates on describing modeling requirements for Layer 1, the PJM footprint. It includes descriptions of real-time model attributes and telemetry requirements used by PJM's security analysis programs. Similar requirements apply to portions of Layer 2 of the model which involves adjacent electric system. Note that data exchange to support Layer 2 real-time models usually occurs directly with the adjacent RTOs/ISOs not TOs. PJM Transmission Owners will usually be involved only if their facilities are impacted.

2.2 Model Information and Data Requirements

Transmission Owners and Generation Owners are responsible for providing the information and data needed by PJM to accurately model their electrical system. PJM models have multiple data attributes, including modeling the physical devices, appropriate limits, substation and network connectivity, telemetry to support State Estimation, etc. The data and information to be submitted to PJM Model Management Department includes, but is not limited to, the following:

- Substation topology (including generator substations), facility connectivity and physical location upon request (State and GPS coordinates)
- Equipment names or designations
- Facility physical characteristics including impedances, transformer taps, transformer tap range, transformer nominal voltages, etc.
- Facility limits and ratings
- Voltage control information and recommended set-points
- Recommended contingencies to be studied
- Protective device clearing times, as appropriate, to support Real-Time transient stability analysis
- Buses, breakers, switches and Injections or shunts such as Loads, Capacitors, SVCs, etc.
- Lines and series devices (reactors or series capacitors)
- Transformers and phase shifters
- Generator auxiliary, station service or common service loads (MW & MVAR)
- Generator step-ups to be modeled for BES generators
- Generator 'D' curve limits
- Real-Time analog and equipment status telemetry* for transmission elements, including but not limited to:
 - Breaker, switch or other equipment status required to determine connectivity

Formatted: Indent: Left: 0"

Formatted: Indent: Left: 1"



- o Real (MW) and reactive (MVAR) power flow for lines, transformers (high or low-side), phase shifters
- o Real (MW) and reactive (MVAR) for loads and/or other injections as appropriate
- ☉_ Reactive (MVAR) power flow for caps, SVCs
- ☉_ Tap position (fixed and variable) for transformers, phase shifters and variable shunt devices
- ☉_ Reportable non-telemetered facility and equipment status
 - Real-Time analog and equipment status telemetry* for generation, including but not limited to:
- ☉_ Breaker, switch or other equipment status required to determine connectivity
- ☉_ Real power flow (MW) Specify if net or gross
- ☉_ Reactive power flow (MVAR) Specify if net or gross
- ☉_ Voltage (kV)
- ☉_ Plant auxiliary, station service or common service load (MW & MVAR)
- ☉_ Note: Must be able to calculate net if gross output available or calculate gross output if net available
- ☉_ Reportable non-telemetered facility and equipment status
 - * Also see Manual 1, Control Center and Data Exchange Requirements.

Formatted: Indent: Left: 13.14", First line: 1.8", Right: 0.05", Space Before: 0.6 pt

Formatted: Indent: Left: 1", Right: 0.04", Space After: 12 pt

Formatted: Indent: Left: 1"

Formatted: No bullets or numbering

Formatted: Indent: Left: 0"

Formatted: No bullets or numbering



2.3 PJM Bulk Electric System* Transmission Facilities

See Manual 3, Transmission Operations Section 1 Transmission Operations Requirements for descriptions, requirements and discussions about:

- PJM Transmission Facilities
- Reportable Transmission Facilities
- Observable Transmission Facilities
- Monitored Transmission Facilities
- Monitoring Requested by the Transmission Owner
- External Transmission Facilities
- Non-PJM OATT Transmission Facilities
- Transmission Facilities Not Monitored by PJM
- Local Facility Protection

*See Appendix C Bulk Electric System (BES) Definition Implementation at PJM for more information.

2.4 PJM Congestion Management Facilities

Facilities under PJM Congestion Management (or Reliability & Markets) Control

Note: In this manual, the terms Congestion Management and Reliability & Markets will be used interchangeably.

PJM has developed standards that Transmission Owners must follow in order for PJM to operate generation to control loading or voltage on transmission facilities. See Manual 3, Transmission Operations, Section 1.

See overview reference to the Transmission Services Tariff Facilities list on the PJM website.

2.4.1 Telemetry Requirements for Facilities to be added to Congestion Management Control.

For a transmission facility to be added to PJM Congestion Management Control, the facility must be “observable” (as defined in M3, Section 1) with sufficient telemetry redundancy to ensure accurate and reliable State Estimates. Generally, telemetry requirements are noted below:

Lines, phase shifters or series device:

- The branch has MW/MVAR telemetry at both ends and there is some MW/MVAR telemetry for other branches/injections at buses connecting to the branch, or
- The branch has MW/MVAR telemetry at only one end and there is good MW/MVAR telemetry for other branches/injections at buses connecting to the branch, or



- The branch has no MW/MVAR telemetry at either end but it has almost perfect MW/MVAR telemetry for other branches/injections at buses connecting to the branch.

Buses:

- Buses are “observable” if there is at least one voltage telemetry point and there is MW/MVAR telemetry for its branches and injections, or
- The bus does not have any voltage telemetry point but a voltage telemetry point is available at the immediate neighbor bus (of the same voltage level) AND the bus being evaluated has all generation injections (for each generator connected and modeled) and most of the MW/MVAR telemetry for its branches and injections.

Refer to PJM Control Center and Data Exchange Requirements (M01), Section 3 and PJM Transmission Operations Manual (M03), Section 1 for additional details. PJM’s Manual for Generator Operational Requirements (M14D) contains additional information about telemetry requirements.

2.4.2 Process to Change the PJM Congestion Management Control Facilities List

The process and timeline below is to be followed by Transmission Owners (TOs) requesting PJM to:

- assume congestion management control responsibility of additional transmission facilities;
- alter attributes such as ratings for all, or most, facilities of a given type when fundamental changes in assumptions or philosophy are required;

OR,

- remove facilities from the congestion management list.

By Sep 15, TO must verify that all additional transmission facilities to be nominated for inclusion in Congestion Management are properly modeled, with appropriate telemetry, in the PJM EMS model. (See Telemetry Requirements for Congestion Management Control below.) PJM staff is available to provide assistance if needed. EMS model adjustments must be coordinated with PJM’s deadline (Sept. 15) for the November update. Note that, as a part of the PJM EMS model update procedure, the TO must indicate whether a new construction facility will be under PJM congestion management control.

Between Sep 1 and Dec 1, TO formally submits the request, addressed to the Manager Model Management, for PJM to: Assume congestion management control responsibility of the additional facilities effective June 1 of the following year. All requested facilities must be transmission facilities, according to the FERC “seven-point” test, covered under Attachment H of the PJM OATT, and must be in the EMS model by the November model update. As a part of the request, the TO must submit the following:

- Thermal ratings of the requested facilities, as per PJM Transmission Manual



- Voltage limits of the requested facilities, as per PJM Transmission Manual
- A recommended list of contingencies to be evaluated by PJM for the requested facilities

Dec. 1 to 8 PJM informs internal organizations of the proposed changes, including Market Operations, Operations Planning, Transmission & Interconnection Planning, Market Monitoring, etc., as appropriate. PJM will post all pending requests on the PJM OASIS website shortly after the Dec 1 submittal deadline. The notice will be of the general form:

Special Notice: Additional facilities will be under PJM congestion management control.

Effective, June 1, 20xx PJM will assume congestion management control of additional transmission facilities in COMPANY. [Click here for the list of additional facilities.](#)

OR

Special Notice: Attribute (rating) changes affecting numerous facilities under PJM congestion management control are required.

Effective, June 1, 20xx PJM will begin using the revised attributes (ratings) as part of congestion management control of facilities in COMPANY. [Click here for the list of facilities affected.](#)

OR

Special Notice: Facilities are scheduled to be removed from PJM congestion management control.

Effective, June 1, 20xx PJM will remove the specified facilities in COMPANY. [Click here for the list of facilities affected.](#)

Dec. 1 to Feb 15 PJM Market Operations, Market Development and Market Monitoring will assess anticipated changes in congestion as a result of adding, removing or altering attributes (ratings) of facilities in the PJM congestion management control list. PJM Transmission & Interconnection Planning performs analysis to ensure that the system resulting from the changes meets the PJM Reliability Planning Criteria or if any system problems result from the proposed changes. PJM Transmission performs telemetry and observability evaluation of incorporating the proposed changes. PJM Operations Planning performs operating studies and EMS studies to ensure reliable operations when the requested changes are included as part of PJM congestion management control.

Feb. 1 Coordinate changes with upcoming ARR/FTR auction (for June 1 to May 31 of the following year). The annual network AAR/FTR nomination period ends Mid-March.

Feb. 15 TO will be informed of the results of the planning, telemetry and observability evaluations. Market Operations, Market Development and Market Monitoring will report on their assessment of the impact on Congestion Management of the changes.

March 1 TO will be notified by March 1 whether PJM can assume congestion management control on June 1. PJM informs appropriate internal organizations of the proposed changes, including Market Operations, Market Development, Operations Planning, Transmission & Interconnection Planning, Market Monitoring,

March 1 to March 8 The list of requested facilities added, removed or re-rated will be posted on PJM website to notify market participants of the changes in the list of facilities under PJM



congestion management control effective June 1. For new construction facilities, the expected in-service dates will be posted.

- | June 1 PJM adjusts (adds, changes, removes, etc.) congestion management control to accommodate the requested facility changes. For new construction facilities, PJM will assume congestion management control when the facilities are put in service.
- | For TOs integrated into PJM after September 1 of the previous year, requests to remove facilities currently under PJM congestion management will be accepted until Feb 1, to be effective June 1.
- | PJM reserves the right to grant exceptions to this timeline in order to maintain system reliability.

2.4.3 Process to change Post Contingency Congestion Management Facilities

PJM supports a Post Contingency Congestion Management program. With this program, TOs can obtain permission to operate facilities beyond calculated post-contingency limits for select facilities. Only low-impact facilities are eligible (i.e., will not contribute to system cascading) for the program. To request an exception for PJM Operations to accept an automatic switching scheme at a specific location, the TO must submit a formal request to the PJM System Operations Subcommittee (SOS). The TO must attach necessary documentation and study results demonstrating the scheme will function under all operating conditions as designed.

TOs must identify the facilities under consideration for Post Contingency Congestion Management, along with the remedial action scheme to be employed (switching, generator ramping, etc.), and any attributes such as ratings which are to be altered. This information is required along with the documentation and study results noted above.

- | Changes to the Post Contingency Congestion Management Facilities (additions, changes or removals), are initiated by the Transmission Owner via request to the manager of PJM's **Real-Time Data Management Department**. Changes will be implemented following the same timeline as the Process to Change the PJM Congestion Management Control Facilities List schedule listed above.
- | For information about PJM's Post Contingency Management program, see Manual 3 Transmission Operations. M03 also includes Attachment G which documents facilities which have been approved and are eligible for the Post Contingency Congestion Management Program.



Section 3: EMS Data Collection Process

Welcome to the EMS Data Collection Process section of the **PJM Manual for Energy Management System Model Updates and Quality Assurance**. In this section you will find the following information:

- “Background on PJM EMS System Model Updates”
- PJM Transmission System Model Update/Data Collection Procedures
- PJM Ratings Data (Thermal Equipment Ratings Monitor – TERM)
- Interim Update Capability
- Naming Conventions

3.1 Background on PJM EMS System Model Updates

This document is intended to describe the philosophy guiding PJM's EMS model update and validation procedures, specifically identifying feedback and information about the PJM models available to users. At the present time, it is not intended to serve as a detailed user's guide or training manual for those involved in the day-to-day business of updating models.

PJM's operating footprint encompasses all, or portions of District of Columbia, Delaware, Illinois, Indiana, Kentucky, Maryland, Michigan, New Jersey, North Carolina, Ohio, Pennsylvania, Tennessee, Virginia, and West Virginia. Modeling such a large system and keeping the model up-to-date is a complex process, requiring cooperation between PJM and member companies, as well as, neighboring or 'electrically close' utilities, RTOs, etc. The models are developed for multiple purposes, including Real-Time Security (Model Update, State Estimation, Security Analysis, Transient Stability and Voltage Stability Assessment) and Study-mode simulations for short-term operations analysis (primarily outage planning), as well as, Day-ahead Markets, Real-time LMP and Security Constrained Economic Dispatch calculations and FTR auctions. In addition, tie-line, and tie-line metering data, is translated for used in PJM Generation Control algorithms.

The System Operations Subcommittee - Transmission (SOS) representative is responsible for models of their system. Typically, the SOS-T representative designates an alternate or relies upon the Data Management Subcommittee member to provide information in accordance with PJM schedules.

eDART's Network Model application is used to collect data needed to model planned system changes. This data is interpreted and coded to prepare updates and input for the Siemens' suite of EMS network applications (i.e., state estimator, security analysis, etc.). In addition, the model changes are forwarded to other PJM groups to incorporate these changes, as appropriate, into models used by Day-ahead Markets, etc. Changes such as new tie-lines, which impact Automatic Generation Control systems, are also derived from the changes submitted as part of the modeling build process.

There are many inter-dependent systems and multiple stakeholders utilizing the basic model data, requiring significant coordination. Consequently, PJM restricts regularly scheduled updates of the EMS model to four times each year.



Two of these updates, commonly known as the Summer and Winter builds, follow a formal process with PJM Transmission Owners providing input. Data which may impact models is also gathered by PJM staff from the PJM Regional Transmission Expansion Plan (RTEP), as well as, the Generation and Merchant Transmission Queues. The builds model electrical grid modifications resulting from the near-term, future transmission and generation construction projects reported by Transmission and Generation Owners throughout the PJM footprint. The two (2) formal model builds planned for each year with transmission owner and generation queue input, are scheduled on, or about, June 1 and December 1.

Two other EMS updates are performed each year. These builds are focused on updating or expanding the external system models as required but also serve as additional opportunities to correct known problems with PJM Generation and Transmission Owner facilities. These builds are scheduled on, or about, March 15 and September 15 each year.

Limiting model builds to four times per year ensures a 'stable' model for all stakeholders/participants.

Although fairly common practice in the industry, a 'just in time' approach to model building, (i.e., performing updates as construction projects are completed) is not feasible in the PJM environment. As a result, PJM employs a 'double-model' strategy. Existing substation configurations, as well as, the planned configurations, are modeled. The double-model permits PJM to re-configure the model on-line to reflect the connectivity of new construction and to retire equipment on-line as necessary. PJM typically employs 'dummy' switches to incorporate the pre- and post-construction configuration.

Although developed initially for reliability purposes, the EMS model updates also serve as the basis for updates to the commercial models used in PJM Market programs. Commercial model support staff members modify and adapt the network model for use with these Market applications. Hence, the Operations and Markets models are essentially identical. After extensive testing, PJM transfers new EMS and Market system models into production concurrently.

Many other database systems depending upon the EMS network model and the EMS model update process receive one or more of the following:

- a full copy of the EMS network model;
- a data extract from one of the EMS databases;
- a list of incremental EMS changes; or,
- a PSS/E conversion of the EMS network model.

Implementation of the data from the new model builds is also coordinated with other PJM applications such as eDART (Outage Scheduling, TERM, etc.)

Note that PJM will schedule additional model builds if justified.

3.2 PJM Transmission System Model Update/Data Collection Procedures

Periodic updates to the PJM EMS are required. A key to maintaining accurate PJM reliability and market models is timely submission of the transmission model changes which are to be included. Advance or early notification is essential to success. TOs are required to notify



PJM from 6 months to 1 year in advance of system changes. The EMS network model is then formally updated twice each year to reflect the TO changes. Model upgrades are targeted for completion May 1 and December 1. The May 1 update is referred to as the Summer update and the December 1 update is referred to as the Winter update. To be assured that a facility addition, revision, or deletion to be included in an EMS model update, all technical modeling information must be submitted to PJM's Model Management Department before the following deadlines*:

Info Submitted Before	EMS Model Update Date	Target In-Service Date
March February 8*	May	June 1 + 6 months
September 8*	December	January 1 + 6 months

Exhibit 2: Deadlines for Submitting Modeling Data

- *Note that the deadlines listed in this document are approximate, indicating that data should be submitted on, or before, mid-month February and September. In reality, the schedule will vary with the calendar. Typically data is required by close of business on a Friday near mid-month.

Each summer and winter update schedule follows a similar time-line pattern. Prior to the scheduled model change-over production date, Transmission Owners are notified that the PJM EMS model will be updated and date specific requirements are provided several months in advance of the due date. These notices are typically emailed in mid-December for the summer update and in mid-June for the winter update.



Timeline for Model Update – Sample

Process Timeline

TOs must include transmission model changes effective on or before December 20xx

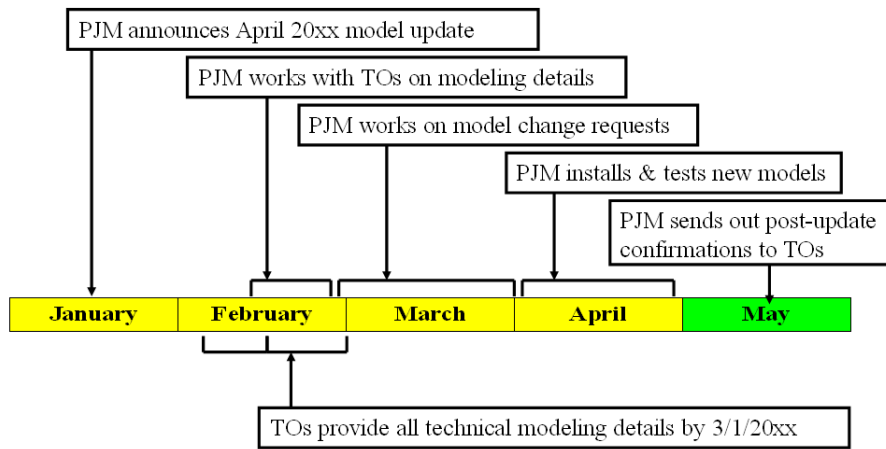

8

DMS#133790

Exhibit 3: Timeline for Model Update—Sample

As part of the email initiating these data requests, a list of projects on record in PJM's generation and transmission planning queues is attached for the TOs to review. TOs are expected to review the projects on record at PJM and validate that they correlate with information available internally, reporting any differences to PJM operations representatives involved with the data collection process. These differences are fed back to PJM planners who review the information with TO planning organizations to reconcile any differences.

PJM's goal is to prepare model additions well in advance of actual construction. TOs are responsible for providing data about all construction projects that will impact the PJM model during the coming six month period. This six month period (window) is defined as construction to be started and/or completed from June 1 through Dec. 31 for the Summer build and as construction to be started and/or completed from Jan. 1 through May 31 for the Winter build. It is of interest to point out that the PJM Summer build includes construction that will be occurring in preparation for Winter peak load periods and the PJM Winter build includes construction that will be occurring in preparation for Summer peak load periods.

Because construction completion deadlines tend to be somewhat tentative or variable, PJM prefers to operate on the conservative side. That is, PJM will accept data for projects beyond the six month window even though TOs indicate there is some uncertainty about the



completion date, provided there is a high confidence that the project will be funded and completed in the subsequent 6 to 12 month period.

Transmission Owner representatives should use the eDART Network Model function to record changes. The system requires users to provide a project description and an in-service date for the project. The user is then prompted to select from a drop-down list of existing substations in their model to make changes or to enter a new substation name. Additional prompts are provided to illustrate all the equipment presently modeled at PJM within each substation (breakers/switches, lines, loads, series devices, shunts, SVCS/generators, phase-shifters and two-winding transformers). Users are required to enter data through the appropriate forms modifying existing equipment by selecting the device to be modified and/or enter data to describe new equipment. Descriptions of each field are incorporated into the data collection tool. Users can also download one-line diagrams for each substation modeled by PJM within their service territory.

Users are required to provide the following general data items:

- One-line of the project which is to be attached as a file to the project
- Brief project description with an abbreviated TO name in the 1st three characters
- In-service dates for the project and individual equipment if phased in
- Names used internally for the various devices
- Impedances in p.u. on 100 mVA of lines and other lumped parameter devices
- Load transfers, estimated peak load and power factor
- Shunt size
- Phase shifter taps and MW/Phase Angle targets and range
- Available telemetry
- Transformer nominal voltages, taps and
- SCADA linkages
- Denote that the project involves tie-lines
- Denote the internal TO and PJM project ID as appropriate

Forms for each type of equipment in the EMS database (breakers, lines, transformers, shunts, series devices, phase shifters, loads, generators/SVCs) have been created and can be referenced through the eDART Network Model (data collection) function.

PJM staff members are responsible for interfacing the necessary generation data and models to be used. If Transmission Owners have information about the various generation projects in their areas, it is recommended that this data be submitted as a project or validated as previously modeled. Generator information is derived directly from the PJM generation planning queue information and will be correlated with information provided by TOs regarding generation projects within their 'footprint'.

TOs are encouraged to provide data to represent updates to occur on their systems to the degree they feel appropriate. PJM reserves the right to make adjustments deemed appropriate and sufficient to model and support PJM's mission to support Bulk Electric



System reliability and economics. As a result, PJM may elect not to model everything the TO provides. Therefore, the PJM model is expected to be similar to, but not necessarily the same as, individual TO Real-Time or planning models.

Tie-line projects require extra attention, especially those involving ties with non-PJM entities as they impact the control area signals required for Automatic Generation Control (AGC). Consequently, projects involving tie-lines need to be clearly identified using the Tie-Line Yes/No flag in the line data section of the eDART Network Model application (section 4.)

PJM also recognizes that not all project data may be available initially. TOs are requested to provide information to the best of their ability to meet the scheduled data due-dates. If necessary, TO staff members are to contact planners in their organizations to obtain approximate impedances or reference the data from applicable MMWG cases, etc. As more exact data becomes available, TOs are required to update the projects using the eDART Network Model (data collection) tool. For example, SCADA information and ratings data are often not available initially. It is the responsibility of the TO to submit appropriate data to PJM as soon as it is available. The data must be received by PJM not less than 2 weeks prior to the scheduled cut-in.

eDART outage tickets allow the user to flag outages that involve model changes. TO model representatives should coordinate with those submitting eDART outage tickets to ensure that this flag is set as appropriate. The flag is used by PJM to assist in coordinating new equipment cut-ins requiring model changes.

PJM staff members are responsible for preparing Network Model Update Packets which include:

- A marked up PJM EMS one-line for each impacted substation
- A one-line for any new substation to be modeled by PJM
- In-service dates and project ID are noted on the one-lines
- Dummy switches used to convert from existing to future configurations
- Pertinent information for operators will be noted on the one-lines
- Diagrams and other information provided by users
- Clear identification of tie-lines

PJM staff members are responsible for regularly exchanging model data with other members of the various PJM Joint Operating Agreements (JOAs). Through the data exchange process, model updates will be assessed and incorporated into the PJM models as required. Generally, real-time data is interfaced to the PJM models for areas of particular interest/concern (see Layer 2 in Exhibit I). These portions of the external electrical models are modeled in detail with supporting real-time status and analog data obtained from other RTOs, plus adjacent TOs. As one would expect (and following the physics of the interconnected systems) the areas of interest tend to be along EHV and high-voltage paths extending from PJM into adjacent systems. These electrically close areas are then State Estimated, along with the rest of the PJM interconnected footprint.

Where possible, generators in the outside systems are also modeled to take advantage of available telemetry. Using engineering judgment and operating experience these boundaries are extended as required and systems that are electrically remote will either be



equivalenced or eliminated. PJM has agreements with adjacent systems to exchange model data on a regular basis. PJM staff members involved with model support review the model changes received from outside entities. The PJM staff then establishes dialogue with the outside entities to obtain model details if required to maintain an accurate representation of the outside systems. These data exchanges have been accomplished in several different formats (CIM, PSSE, **SERC**, etc.). It is an evolving process.

| The elements of the system to be monitored for possible limit violations is defined in the EMS and posted on the PJM OASIS under System Information in the Ratings.txt file which is updated daily.



The figure below illustrates the relative level of detail for areas modeled in the PJM EMS.

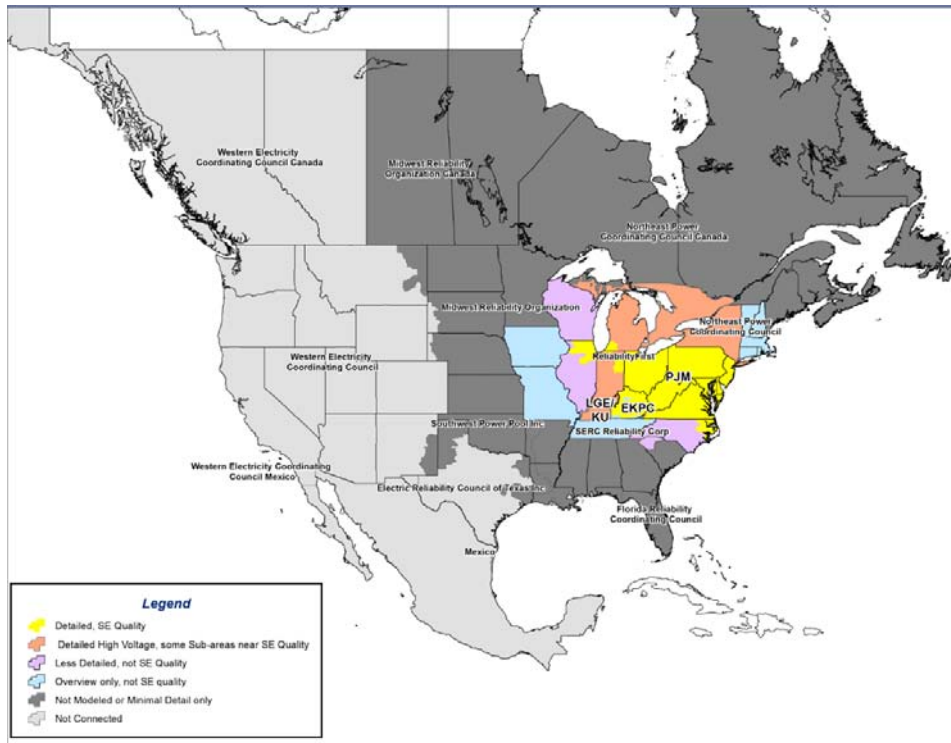

[Exhibit 4: PJM EMS Model Details](#)

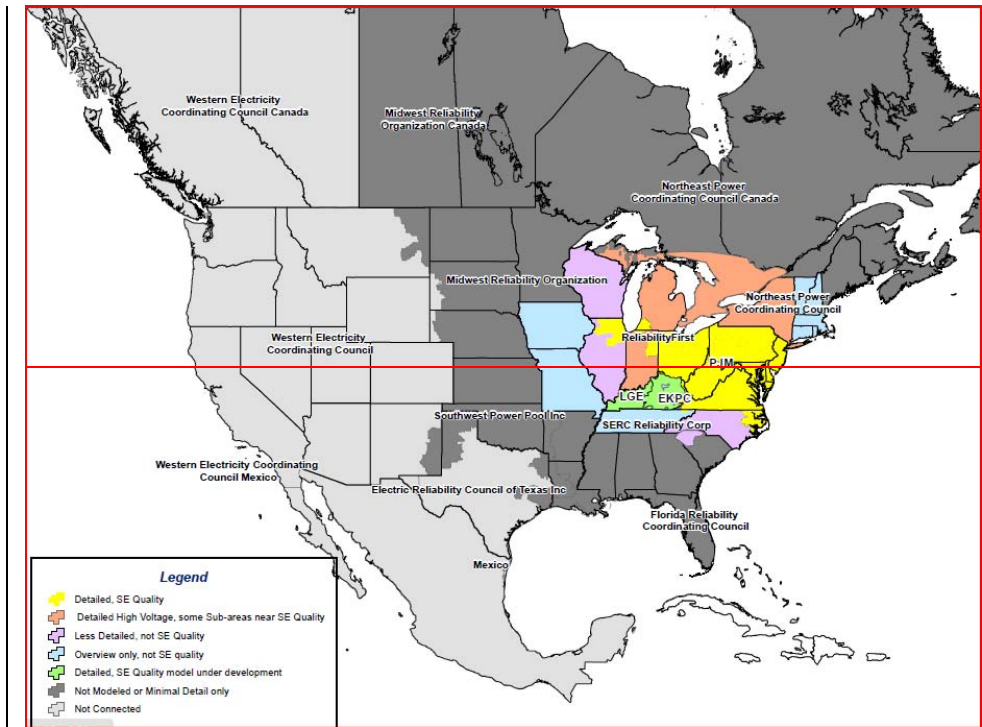

Exhibit 54: PJM EMS Model Details

Formatted: PJM_Normal



3.3 PJM Ratings Data (Thermal Equipment Ratings Monitor – TERM)

Another eDART function is the Thermal Equipment Ratings Monitor, or TERM. All facilities in the PJM EMS model are transferred to eDART immediately after each model update build. Transmission Owners should be able to enter ratings data in accordance with PJM policy for each facility in the database – lines, transformers, series devices and phase shifters. (The capability to enter circuit breaker ratings is being developed but is not currently available.) PJM requires ratings for 8 temperature sets - 95, 86, 77, 68, 59, 50, 41 and 32 degrees Fahrenheit. Users can also differentiate between day and night limits by entering values reflecting direct solar heating of conductors.

In addition, PJM systems expect Normal (continuous), Emergency (equipment capability for up to 4 hours with long term and short term emergency set equal unless specifically approved otherwise) and Load Dump limits (equipment capability for up to 15 minutes duration). These represent progressively increasing severity of loading. See **Section 2 Facility Ratings Definitions and Data Procedures in M03 Thermal Operating Guidelines** for more information on how PJM operators use ratings information. Also see Appendix A of this document for more information regarding processing TERM tickets at PJM.

See **Section 2 How to Change Facility Ratings in M03 Transmission Operating Guidelines** for additional information about TERM usage, as well as, bulk loading ratings updates.

3.4 Interim Update Capability

PJM's EMS is capable of performing some limited, interim updates if, and as, required. This practice is not a preferred operating practice and is primarily utilized when impedances need to be revised. If there are model problems, representatives of Transmission and Generation Owners are encouraged to contact PJM to review the situation and determine if, and when, corrections can be made. The eDART TERM function provides the ability for users to view existing R, X and B (resistance, reactance, and susceptance) information and input R, X, B adjustments. Only impedance revisions which are expected to have a significant impact on the State Estimator solution will be implemented immediately with others processed as part of the routine build process.

3.5 Naming Conventions

Company names are limited to 5 characters

Substation names are limited to 8 characters

PJM attempts to make every substation name unique

A 2 character designation is embedded in substation name if it is a duplicate

Generators are to be named after localities or land marks to avoid confusion if sold

The following standards are currently in use for unit naming:

- G-1 : Generic Generator



- GT-1/COTU-1/CT-1 : Gas Turbine/Combustion Turbine
- ST-1 : Steam
- CC-1 : Combined Cycle
- D-1 : Diesel
- HYD-1 : Hydro
- WF-1 : Windfarm
- LF-1 : Landfill
- NUG-1 : NUG (Non-Utility Generator).
- SP – Solar Park



Section 4: EMS Model Change Control and Feedback

Welcome to the EMS Model Change Control & Feedback section of the **PJM Manual for Energy Management System Model Updates and Quality Assurance**. In this section you will find the following information:

Describe feedback and data available to TOs regarding their models, including:

- Overview of EMS Model Change Control and Feedback
- Bus Connectivity and Engineering Data
- Substation Nodal Connectivity
- Cut-ins and Contingencies
- SCADA Mapping
- One-line life cycle
- Data Management Working Group

4.1 Overview of EMS Model Change Control and Feedback

PJM shares the concern of all TOs that it is important to provide the best models, and therefore the best analysis, to operators for reliability and commercial evaluations of the system. To this end, PJM has been progressively improving the information available to Transmission Owners participating in the EMS model update process. The type of feedback required is two-fold. First, and foremost, participants in the model building process need to receive confirmation, and validate that the changes they've submitted have been correctly incorporated into the PJM EMS models. Second, participants in the process want information about changes submitted by others so they can then appropriately modify internal real-time models. Due to confidentiality restrictions, PJM is not in a position to freely share all information available. Consequently, the distribution of information about the changes made to PJM models may be restricted.

~~In response to requests to~~ To improve feedback to participants in the data gathering process, PJM ~~initially began~~ ~~providing~~ summaries of model changes placed in the production PJM EMS models. Since, as noted earlier in this document, System Operation Subcommittee – Transmission (~~SOS-T~~) members are designated as the 'owners' responsible for transmission models of their system, model change data is channeled through representatives of that group.

The data made available is summarized in the spreadsheet format shown in Exhibit 6 Sample Model Update Build Summary below.

<u>ID</u>	<u>Co.</u>	<u>Series</u>	<u>In-svc</u>	<u>Model Updated</u>	<u>Short Description</u>	<u>Long Description</u>
<u>N</u>	<u>CO1</u>	<u>YYW</u>	<u>MM/DD/YY</u>	<u>MM/DD/YY</u>	<u>Revise Grandview, 138 kV supply</u>	<u>At Grandview, install new bkr., xfer Schneiderville line to new position</u>

Exhibit 6: Sample Model Update Build Summary

Detailed model change information is also summarized and provided on a substation and equipment level, along with a snapshot view of the EMS one-lines in use at PJM at the time

- Formatted: Font: 9 pt
- Formatted Table
- Formatted: Font: 9 pt
- Formatted: Font: 9 pt
- Formatted: Font: 9 pt
- Formatted: Font: 9 pt



of the most recent model build. Preliminary detailed reports will be made available to TOs providing model update inputs as soon as practical after installing the new model on the Test system. However, users are cautioned that the data is subject to change as described in section 5.1.2.3 Validation & Benchmarking New EMS Models.

In addition, Transmission Owners have multiple views of the EMS data base available to them, including eDART connectivity information and power flows provided to Transmission Owners to support day-ahead planning. Power flows used to support the FTR Market are also available (note that Market models are based on the PJM EMS model). Through the power flows, Transmission Owners have access to engineering data such as impedances, load buses, etc. (Note: Impedance data is also available to Transmission Owners via eDART/TERM application forms. In addition, the eDART Network Model application allows users to access copies of PJM's EMS one-line diagrams (in Adobe SVG format). PJM constructs EMS one-lines to reflect both existing and future conditions. Participants meeting established EMS model update schedules are able to view planned changes in advance since new projects and system changes are included in the PJM models approximately six (6) months before going into service. However, the new equipment will remain switched out of service until going live. To assist users, PJM issues a change summary sheet upon completion of each new EMS build. PJM will make details of the changes available to SOS-T, DMS and designated Transmission Owner users upon request. (PJM reserves the right to reject the request.) It is the responsibility of participants in the model building process to review the change summary sheets, one-line diagrams, and other information.

Project ID	Company	Series	In-service Date	Model Updated	Short Description	Long Description
NNNN	GO1	05/06W	12/25/2006	12/1/2006	Revise Grand-Jet. 138-kV supply	At Grand-Jet. transfer 138-kV Tap to Schneiderville to new 138-kV position. Install new 138-kV breaker.

Exhibit 5: Sample Model Update Build Summary

SOS-T members or their representatives are charged to validate that PJM represents their systems accurately and to provide corrections as required. Several additional mechanisms have been made available as support for this process has evolved to supplement eDART connectivity information available through tiers.

PJM reserves the right to initiate selective model audits, with the support of SOS-T, in the future.

PJM has provided information for TOs to review and validate their models. It is expected that SOS-T members will use the data available to them to develop processes internal to their organizations to verify that the PJM models correctly represent the connectivity and engineering data provided by them to PJM. This data is now available through a variety of mechanisms. A discussion of more advanced mechanisms to intended for use by Transmission Owners to validate engineering data and substation nodal connectivity follows. TOs are expected to review the available information and provide feedback regarding problem areas within two weeks of receiving the update information from each model build.



- | Users are responsible for providing data according to the established schedules and for reviewing information and providing corrections as required.
- | Regularly scheduled meetings of the Data Management Subcommittee, hosted by PJM, are also an opportunity for TOs to obtain feedback about projects in adjacent utilities. These meetings are held in February, May and November each year.
- | Specific information is also made available upon user request. In addition, users can email data recorded in the eDART Network Model application to each other.

4.2 Bus Connectivity and Engineering Data

PJM provides feedback to TOs regarding bus level connectivity and engineering data in a variety of formats. TOs are encouraged to take advantage of accessing the data available to them. Ratings and impedance data (R, X, B) of lines, transformers, phase shifters and series devices is available to approved transmission users of the eDART TERM function. TERM also provides users with information about the Monitored Priority status of their facilities. Users are able to submit tickets for impedance changes. These changes can be made by PJM staff on-line without a complete EMS build. However, it is anticipated that the changes will primarily be required when preliminary data was used to model a construction project and that actual data is found to be different upon completion of the project. The application can be used for error corrections, too.

Another option for users is that engineering data is available for review in load flow formats. Impedance and bus-level connectivity is shown in the models used to support FTR (monthly & annual) Auctions and Day-ahead analyses. Models are posted to the Market web-site as part of the Annual and Monthly FTR auction process. The Markets models are available to TOs and all other Market participants. They are derived directly from the EMS model. TOs are encouraged to review and validate these models. Alternatively, data derived directly from the daily load flow analyses performed to evaluate day-ahead reliability and also used for other short-term operating studies is also available. Authorized TOs subscribing to eDART have access and can review these load flows, commonly referred to as day-ahead load flow cases, at any time. TOs are responsible for reviewing and reporting errors.

- Model (bus) changes are posted for RTLMP so that is an official public source. <http://pjm.com/markets-and-operations/energy/real-time.aspx>
- An FTR model is also posted on the FTR model page which represents the base topology used in markets. <http://pjm.com/markets-and-operations/ftr/model-information.aspx>. To gain access to the power flows, a customer needs CEII access. That can also be accessed at the link above.

Although limits (ratings) can be reviewed using the available power flow information noted, it is recommended that TOs use TERM as the source of all ratings data.

4.3 Substation Nodal Connectivity

eDART is populated directly from the EMS model after the completion of each build. Equipment B3 text names and nodal connectivity information is available through the eDART OUTAGE function. Connectivity information is also provided to users by eDART via 'tiers'. With this feature, users can view model components up to three (3) connections from the location they are currently viewing.



In 2006, eDART was enhanced to provide additional model data feedback. In addition to creating change requests describing new equipment, these enhancements, called the eDART Data Collection/Model Update function, allows users to recall information about existing substations. The information displayed includes all equipment modeled within the substation (B3 names, lines, phase shifters, transformers, shunts, breakers, switches, series devices and SVCs/generators). Engineering data such as impedances, voltage levels, tap sizes, etc. is also presented on the forms used to describe the various pieces of equipment in this new software.

In addition to the engineering data feedback, the new eDART functionality makes 'snapshots' of PJM EMS one-lines (static data only) available to users through the Network Model application. The snapshots detail substation lay-outs as modeled in the PJM EMS and used by PJM operators. Due to confidentiality restrictions, the one-lines available are restricted to those substations owned by the TO accessing the data. See Exhibit 6 for PJM One-line diagram symbols

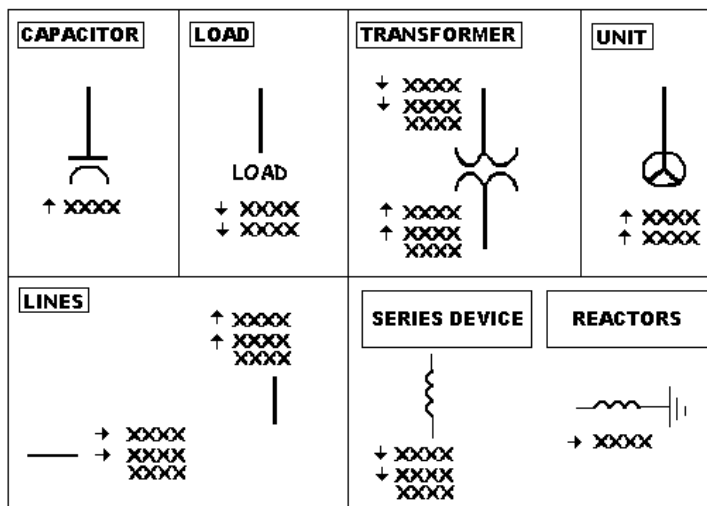

Exhibit 6 One-line diagram symbols

In summary, load flow and engineering data available through eDART and TERM, users is quite extensive. The data has been provided with the primary objective of enhancing each TO's ability to validate models of their respective systems, but the data is available for general purpose use.

If Transmission Owner representatives are submitting data in advance, the one-lines and engineering data provided will afford an opportunity for users to validate models prior to transferring the data into production systems. It is incumbent upon TOs to perform the checks as soon as possible after each build. If corrections are required and PJM receives them in a timely fashion they can be incorporated in the interim builds (March and October),



avoiding last minute adaptations and/or scrambles to correct problems. See Exhibit 6 below which depicts the data collection milestones including requirements for TO validation.

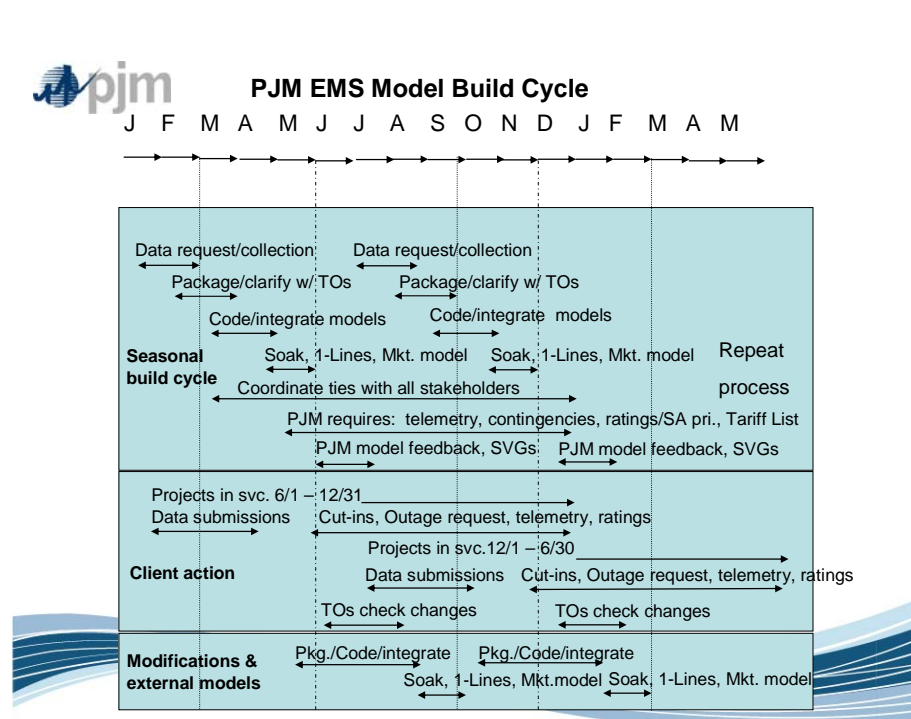

Exhibit 7 - eDART Network Model data submission & model validation timeline

4.4 Processing Tie-Lines

In addition to the need to provide updates concerning tie-lines to ensure that the correct network connectivity is maintained, tie-line projects also impact other systems such as Generation Control and Settlements. Consequently these projects require special attention.

Tie-lines can generally be divided into the following categories:

- External ties between PJM and non-PJM entities;
- Internal ties between transmission zones defining PJM generation control zones;
- Internal ties between PJM transmission zones which do not impact generation control.



Note that tie-lines can also technically exist between PJM TOs and customer equipment, i.e., within a PJM transmission zone. However, these ties are not included in this discussion.

PJM TOs are responsible for working with PJM planners to identify new tie-lines and/or changes to existing tie-lines as part of the Regional Transmission Expansion Process (RTEP). All tie-line projects are to be documented in RTEP (see Manual 14 B).

When submitting EMS model modifications, TOs are also required to clearly identify projects impacting tie-lines using the eDART Network Model flag. When planning outages to the new facilities into service, TOs are required to report the tie-line change to the PJM SOS as part of their regularly scheduled meetings. These reports are to be scheduled at least 30-45 days prior to cut-in and should include references describing and/or itemizing the:

- project stakeholders
- explanation of impact on existing tie-line arrangements
- construction taking place
- cut-in schedule and outage tickets
- metering locations
- telemetry lists
- equipment ratings
- status of legal documents required to approve the tie-line modification

Upon receipt of a Tie-Line Project Package with the Check List, PJM's Generation Department staff will evaluate each project and schedule meetings or conference calls with appropriate stakeholders. Note that the stakeholders involved will include representatives of the tie-line owners, as well as, external balancing authorities and/or reliability coordinators.

4.5 Cut-ins and Contingencies

PJM one-lines and models are created to simulate both pre- and post- construction configurations. Consequently, the substations impacted by construction cut-ins must be evaluated and configured accordingly. When creating one-line diagrams reflecting the pre- and post-construction model, PJM places commentary on the static mask describing the in-service date and any other pertinent information. This makes anyone viewing the 1-line aware that changes are expected.

Provided projects involving re-configurations, replacements and/or new construction projects are received from TOs and processed by PJM at least six (6) months in advance of the in-service date, the equipment to be cut-in will appear in eDART. Consequently, TO outage schedulers will then be able to schedule outages to support the cut-in of this new equipment. In addition, the TO will be able to submit ratings for the new equipment in TERM, as well as, work with PJM staff members to link new telemetry points to support the model changes. In some cases, construction will require more than the usual six (6) months lead-time. In that event, PJM will work with the user to model the new configuration 12 to 18 months in advance, depending upon the circumstances. See Exhibit 8 Model Submission, Build, Quality Assurance Review and Cut-in Timeline below.

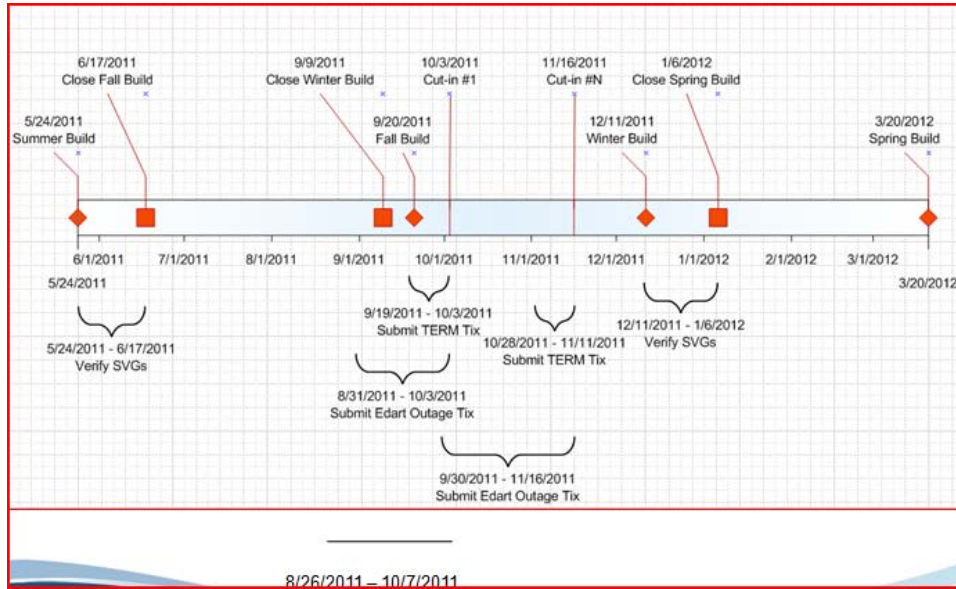

Exhibit 8 - Model Submission, Build, Quality Assurance Review and Cut-in Timeline

eDART Outage Ticket Cut-in Flags

In-service dates submitted as part of the model update process are generally approximate dates. It is important for Transmission Owners staff to use the eDART Outage Ticket 'Cut-in' flag to identify when new equipment or new configuration are actually going in service. TO outage schedulers should simply check, the 'Cut-in' flag near the center of the eDART Outage Ticket form when scheduling outages that will result in a reconfiguration of the electric system.

By setting the cut-in flag on an eDART outage ticket, the appropriate stakeholders are notified that an outage ticket will result in the need to make model adjustments. Consequently, setting the flag is very important to ensure that model changes are implemented in a timely manner. See Exhibit 9 eDART Outage Ticket with Cut-in Flag below.



Manual 3A: Energy Management System Model Updates and Quality Assurance
Section 4: EMS Model Change Control and Feedback

Ticket	219052	User	thomak2	Market Sensitive	<input type="checkbox"/>	In to Hotline Work	<input type="checkbox"/>	Send to Mit	<input type="checkbox"/>	Cause Types Add SF-6 Gas C.B. Overhaul C.B. Replacement CB Maintenance Cable Repair Contingency Planning Cut-in Disconnect/Ground Sw. Maintenance Doble Test Emergency Excludable Outage	
Company	Allegheny Power Control Area			Xmission Sensitive	<input type="checkbox"/>	Emergency	<input type="checkbox"/>	Submit OnTime	<input type="checkbox"/>		
Comp Tick Id				Send to West	<input type="checkbox"/>	SCS	<input type="checkbox"/>	Wep Trip	<input type="checkbox"/>		
Ticket Start	12/18/2007 06:00	Availability	Duration	Send to East	<input type="checkbox"/>	Cong. Expected	<input type="checkbox"/>	Lock Form	<input checked="" type="checkbox"/>		
Switch Date	12/18/2007 06:00	Outage Type	Continuous					PAR Tap for SDX	<input type="checkbox"/>		
Ticket End	03/31/2008 17:30	Status	Completed					Cut In Flag	<input checked="" type="checkbox"/>		
		NOT FOR USE									
		NOT FOR USE									
		NOT FOR USE									
Location/Description of Work (500 character limit)				Add Date		End Ticket					
MEADOW BROOK MD 2 138 KV BKR & MEADOW BROOK MD 3 138 KV BKR Tap new Hampshire 138KV line terminal to 138KV B bus NOTE: THIS BREAKERS ARE NOT IN EDART YET. PLEASE CHANGE THIS OUTAGE TO THE CORRECT BREAKERS WHEN EDART IS UPDATED.				Active Time Stamps							
				Start Date	End Date	TimeStamp					
				12/18/2007 18:40	03/05/2008 14:39	03/06/2008 06:41:06					
PJM Comments (500 character limit)				Add Study				Date Log			
				Study Log				Start Date	End Date	Time Stamp	User
				User	Type	Study Date	12/18/07 06:00	03/31/08 17:30	12/04/07 12:51		
Market Operation Comments (500 character limit)								Ticket History			
								Submitted	Marc200	12/04/07 12:51	
								Received	DANTOJ	12/04/07 13:11	
								Approved	BAKERD	12/14/07 17:47	
								Last Revision		00/00/00 00:00	
Tier Select				Type	Station	Voltage	Equipment Name				
Tier 1				Tier 2	Tier 3						
Generate				Equip Add	Dupe Tick	Dupe Equip	Notify form				
Status	Type	Station	Voltage	Equipment Name		Start Date	End Date	Primary			
Open	BRKR	MEADOWBR	138	MEADOWBR MD2 CB		12/18/2007 06:00	03/31/2008 17:30	<input checked="" type="checkbox"/>			
Open	BRKR	MEADOWBR	138	MEADOWBR MD1 CB		12/18/2007 06:00	03/31/2008 17:30	<input type="checkbox"/>			
Exit				Print	History Log	Email Log	Comment Log	Submit			

Exhibit 9 - eDART Outage Ticket with Cut-in Flag



Dummy switches to model New Facilities

Exhibit 10 below illustrates the use of dummy switches at PJM for dual modeling of pre- and post-construction configurations to support model changes. These adjustments are achieved when PJM staff members alter the status of 'dummy' switches, revising the configuration to represent the new arrangements. New equipment is modeled as connected through normally open dummy switches (i.e. out-of-service). Upon cut-in, the switches are closed and the retired/replaced facilities are then disconnected by opening the dummy switches which were originally normally closed.

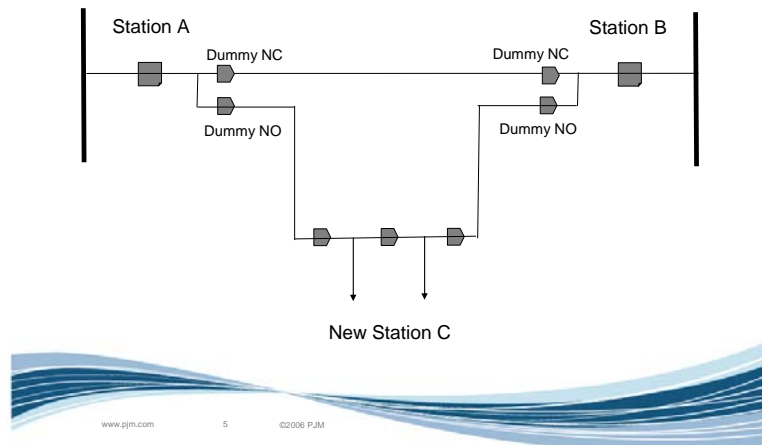

Exhibit 10 - Dummy Switches to model new facilities pre- and post-construction

Cut-in Reports

PJM uses the 'Cut-in' flag to generate weekly reports to help identify when model modifications may be required and verifies that necessary supporting data such as ratings and telemetry are in place. PJM will also ensure that the necessary model modifications are implemented in a timely fashion.

- To facilitate the cut-in process, PJM will publish a weekly list of scheduled outages in eDART that have the Cut-in flag set. The reports include a 6 week look-ahead of all outages tickets that have the Cut-in flag set. See Exhibit 11.
- TOs can filter the information for their individual needs. TOs are expected to review the data for accuracy and begin assembling and submitting necessary ratings data and ensuring that telemetry is provided to support the new configuration. PJM staff members also review this data.



Manual 3A: Energy Management System Model Updates and Quality Assurance
Section 4: EMS Model Change Control and Feedback

Cut-In Flag Report from 5/9/2013 to 6/22/2013									
Ticket	TO	Station & Equipment	Volt	Start	End	Type	On Tin	Description	
511167	AEPSCT	HANGING2 D2 CB 765 KV	765 KV						
514666	AE	DEEPWATE OCB 6604 69 KV	69 KV	6/10/13 6:00	6/14/13 18:00	Continuous	Yes	@Quinton: New Construction reconfig sub. Cutin new	
514666	AE	DEEPWATER-QUINTON 0723-1 69 KV	69 KV					Churchtown-Quinton 69KV	
514666	AE	QUINTON G CB CB 69 KV	69 KV						
504543	COMED	74 KEWANE 38L7423 CB 138 KV	138 KV	6/3/13 6:00	6/16/13 20:00	Continuous	No	#####	
504543	COMED	74 KEWAN L7421 CB CB 138 KV	138 KV						
504543	COMED	74 KEWAN BT105 CB CB 138 KV	138 KV						
504543	COMED	74 KEWANE 38L15508 CB 138 KV	138 KV						
504543	COMED	74 KEWANE 38L7413 CB 138 KV	138 KV						
504543	COMED	74 KEWANE-KEWANE Z1 TIE 138 KV	138 KV						
504543	COMED	74 KEWAN-EDWARDS 7423 TIE 138 KV	138 KV						
504543	COMED	74 KEWAN L9430 CB CB 138 KV	138 KV						
504543	COMED	74 KEWAN-7411 7411 1 138 KV	138 KV						
504543	COMED	81 TOULO-74 KEWANE 7421 138 KV	138 KV						
504543	COMED	74 KEWAN BT1-2 CB CB 138 KV	138 KV						
504543	COMED	74 KEWAN-6101 6101 3 138 KV	138 KV						
504543	COMED	74 KEWAN-BISHOPHI L9430 138 KV	138 KV						
504543	COMED	74 KEWANE 38L6101 CB 138 KV	138 KV						
504543	COMED	74 KEWANE 38L7411 CB 138 KV	138 KV						
504543	COMED	74 KEWAN-15508 15508 4 138 KV	138 KV						
504543	COMED	981 CRES-74 KEWAN 7413 138 KV	138 KV						
513481	AEPSCT	PENNVILL-ADAMSIM 138 KV	138 KV	6/17/13 7:00	6/21/13 13:00	Continuous	Yes	138KV BUS OUTAGE	
513481	AEPSCT	ADAMSIM A CB 138 KV	138 KV					INCLUDING THE 138/69/34KV	
513481	AEPSCT	ADAMSIM-MAGLEY 138 KV	138 KV					TR 1 OUTAGE FOR FINAL	
514668	AE	DEEPWATE OCB 6604 69 KV	69 KV	6/17/13 6:00	6/21/13 18:00	Continuous	Yes	@Quinton: New Construction	
514668	AE	DEEPWATER-QUINTON 0723-1 69 KV	69 KV					reconfig sub. Cutin new	
514668	AE	QUINTON G CB CB 69 KV	69 KV					Churchtown-Quinton 69KV	

Exhibit 11 - Sample 6 Week Look Ahead Cut-in Report



Contingencies

Similarly, contingencies defined in the PJM EMS may need to be altered as system changes occur. Contingency files are re-processed and re-calibrated to align model elements with the contingency definitions as part of the EMS build process. In addition, PJM Model Management and Reliability Engineering Department staff members review the contingency lists to ensure that the definitions are modified to reflect protection scheme changes.

4.6 SCADA Mapping

Also see Section 5 of this Manual, Real-Time Application Support for information about problem solving.

The volume of data to model is extremely large, with some 70,000 SCADA points alone used by PJM. PJM relies on several contributing factors to ensure model accuracy and reliable analytical tools to provide operations support - 24x7x365. To ensure that the on-line programs solve during widely varying operating conditions, PJM must, and does, rely on automation to detect data inconsistencies and problems, and TO support. Complete point by point audits have proven to be time-consuming with extended turn-around times. In addition, the electrical grid is constantly changing and audits have shown to become out-of-date before they can be completed, rendering them not only costly, but somewhat ineffective. Consequently, PJM relies upon the inherent capabilities of the SE solution to rigorously and mathematically assess the data/model to reconcile and/or reveal data inconsistencies. PJM's experience is that the State Estimator effectively solves over a wide range of operating conditions, indicating that the model is highly tuned and accurately reflects real-time conditions. Incorrectly mapped status points are revealed through anomaly detection. In addition, problems reported by various staff members and/or TOs are thoroughly investigated and feedback is provided. Adding metering to areas with minimal observability would serve to enhance error detection.

4.7 One-Line Life Cycle

PJM's EMS depends primarily upon substation one-line diagrams to provide users with information regarding SCADA and State Estimator data. The diagrams are also designed for easy user reference to calculated residuals which illustrate the difference between the calculated SE values and the corresponding SCADA values.

Most of PJM's EMS one-lines have been, and continue to be, created manually. However, the capability exists to auto-generate one-line diagrams. This feature is typically used as part of a process to enhance large areas of the model, when a high volume of one-lines is required. This situation occurs, for instance, during expansion of the RTO and/or when portions of the external model are expanded. Although electrically correct, the auto-generated diagrams are not always as direct and easy to read as are manually created diagrams. Hence, PJM prefers manually creating one-line diagrams to support changes to an existing substation and/or creation of a new substation in the model.

PJM one-lines that reflect the modifications to the model are created during the test or soak period prior to implementing the new data base in the production EMS. The new, and modified, diagrams are converted automatically to SVG format immediately after the new build is completed. The new one-lines are integrated into the eDART Data Collection/Model Update Function. The Transmission Owner is required to review the new and updated



drawings for their areas to ensure that the changes submitted are accurately illustrated, capable of representing both the pre- and post- construction models. Recalling that model changes are to include construction projects at least 6 months in advance, there should be adequate time to correct and adjust models if necessary. To provide an opportunity to make necessary adjustments, it is important that problems and modifications be reported as soon as possible.

4.8 Data Management Subcommittee

The Data Management Subcommittee (DMS), formerly known as the Data Management Working Group (DMWG), was re-formed in 2005 to create a forum for PJM Transmission Owners to provide input and feedback to the PJM EMS model update process. It also gives members of the group an opportunity to exchange information with each other. The meeting is also used as a forum to convey information about models, gain familiarity with related existing or future PJM systems and learn from the experiences of each participating organization.



Section 5: Real-Time Application Support

Welcome to the Real-Time Application Support section of the **PJM Manual for Energy Management System Model Updates and Quality Assurance**. In this section, you will find the following information:

- Discussion of PJM support for real-time applications
- Discussion of solution quality and availability
- Discussion of link availability

5.1 Overview of Real-Time Application Support

As discussed in Section 1 of this manual, PJM's Network Applications (or Real-Time) model PJM companies in detail, Tier 1 company systems, especially high voltage lines and substations) in somewhat lesser detail and systems beyond Tier 1 with minimal details.

5.1.1 Real-Time Analysis

PJM's State Estimator (SE), representing about 13,000 buses runs on a 1 minute periodic trigger with results of the SE solution presented to operators through substation one-lines. The State Estimator serves two major functions:

- It filters data to ensure a consistent representation of the current grid which serves as a base condition for further analyses such as Contingency Analysis; and,
- It provides filtered, near real-time data to PJM system operators to eliminate metering inconsistencies and inaccuracies (for example, multiple voltage measurements at a bus are reconciled, etc.)

Several factors impact the real-time applications and the value of these tools:

- The model must accurately represent the electrical grid to be analyzed for security assessments. The model must also take into consideration the impact of tightly-coupled portions of adjacent electric systems (aka Wide Area View). To support Reliability Coordinator functions, the PJM model must accurately represent the RTO 'footprint' as well as components in adjacent systems.
- At all times, the model must accurately represent maintenance conditions and/or any unusual operating arrangements which alter the grid and resulting flows.
- The solution must be achieved quickly and reliably (good numerical stability over varying operating conditions) to provide operators with high-quality, near real-time information. To maintain high performance and throughput PJM models are intentionally kept to the minimum size possible to achieve acceptable solution results. PJM's SE and Contingency Analysis (CA) programs both are initiated every minute of the day. When all computer hardware and software are functioning normally, SE results are obtained in 30-45 seconds while CA analysis is completed within approximately 60 seconds.



5.1.2 SE Solution Quality and Availability, including Links

5.1.2.1 SE Communication & Data Links

The Network Topology Processor and State Estimator are dependent upon timely receipt of data from generating companies, as well as, transmission owners to provide status and analog information. This data is provided via ICCP-links for transmission and owners of large generating plants. For some small generating companies, SCADA data is used as input.

A link outage report is maintained for all PJM links. When a link is down, the incoming data is obviously bad so it is important to keep the links functioning and providing good quality data. In addition, the TOAC Metrics report records performance statistics representing Transmission Owner performance on EMS, State Estimator Convergence and data (into their system and into PJM system). ICCP links, as well as, links to generating plants are monitored by the PJM EMS. Alarms are generated whenever abnormal conditions occur. Operators and our Reliability Engineering staff are trained to handle some problems directly. If they cannot, during normal business hours back-office staff will be called upon to assist. If off-hours problems occur then PJM has an on-call list to provide support. If the problems are determined to be on the TO or GO end, contact lists have been established to help resolve the problem as quickly as possible.

5.1.2.2 SE Solution Quality & Availability

~~The PJM SE is triggered to execute every minute.~~ PJM maintains a record of State Estimator convergence in spreadsheet form to measure availability. It is calculated monthly as number of converged solutions divided by the total number of attempted executions of the program (converged + non-converged solutions). The SE Convergence percentage is an overall picture of how robust the solution algorithm and model is but the number should be used carefully. Historical convergence statistics illustrate that the model is very well-conditioned, solving in well over 98.7% of the attempted executions. ~~With the PJM SE triggered to execute once per minute this translates to 4 or 5 non-convergent solutions per day.~~

Any non-convergence problems are reported through the EMS alarm package, immediately investigated and resolved as quickly as possible. Operators and on-shift Reliability Engineers are trained as the first line of defense with back-office and call-in staff available for higher level support. Historically, SE divergence is most likely to be caused by problems with the ICCP link data wherein data for entire companies is not available, creating significant data skews and/or erroneous status points, etc.

EMS support staff members routinely:

- Review anomaly tables
- Review residual tables
- Analyze performance indicators such as the number of iterations to converge to a solution and to assess if poor metering or poor modeling is evident
- Investigate all problems reported by operators and reliability engineers.

~~In the effort to ensure model quality and dependable accurate solutions, prior to placing a new model into production, EMS support staff members complete a rigorous 'soak' test.~~



~~The testing interfaces SCADA data directly to the new model to ensure that the models produce a stable solution consistent with the results of the previous model.~~

In addition, upon request PJM staff will exchange results of the PJM SE with representatives of the various TOs to compare PJM and TO SE results and provide a dump of the SE model in PSSe format for the TO's to review.

Results from the PJM SE may be compared to the SE results produced by the TO and/or other company. If there are differences which cannot be readily explained, PJM support staff members will work with TO representatives to compare results and models until all the differences can be explained. Depending upon the results of the investigation, appropriate actions are taken.

During normal business hours, support staff members are available. Members of the PJM EMS support staff coordinate their availability to provide call-in support during off-normal business hours. Restoring SE is afforded immediate priority.

5.1.2.3 Validation & Benchmarking New EMS Models

~~Prior to placing a new model into the production, PJM staff members complete a rigorous 'soak' test. The new EMS model is implemented on a Test system and a complete set of the SCADA data linked to the current real-time model is interfaced to that model. The soak test spans a three (3) to four (4) week period, designed to ensure that the model will produce stable, accurate solutions over a wide array of operating conditions. Results from the test system are compared to results from the production model to determine if they are consistent. As inconsistencies or model errors associated with either State Estimator or Contingency Analysis (see Section 5.1.4) results are uncovered, adjustments and corrections are made to the new model.~~

~~For a two (2) day period prior to the scheduled transfer of the new model to the production system, PJM closely monitors the SE solution on the test system. The test model is ready for transfer to the production system if:~~

- ~~_____ 98% of SE solutions converge~~
- ~~_____ No more than 10 consecutive non-converged solutions~~
- ~~_____ Average number of solution iterations is <20~~
- ~~_____ <=25 bad data points (<.05% of ~ 51,000 kV, mW, mVAR & Tap analogs)~~
- ~~_____ Pre- and post-build SE Bad Data differs by no more than 2 existing locations~~
- ~~_____ Worst anomaly in PJM footprint <50% of reading~~

~~Note that if any unanticipated conditions occur which adversely impacts the results above, PJM will analyze the situation before proceeding with the build. If it is deemed prudent to proceed with the build, documentation will be prepared explaining the circumstances.~~

5.1.3 Contingency Analysis (CA)

PJM's Contingency Analysis program is triggered immediately upon completion of a convergent SE. CA simulates between 4000 and 4500 outage scenarios with full AC analysis every minute of the day. An additional 500, or so, contingencies are defined to simulate special circumstances such as Maximum Credible disturbances. These are run on an exception basis. Both the real-time sequence and power flow are able to execute these

Formatted: Font: Not Italic

Formatted: Font: Not Italic



contingencies for a thorough analysis of the behavior of the electrical system in response to the various scenarios. The vendor's software makes adding new contingencies fairly routine and each element that is to be included in a given contingency must be defined. The contingencies are originally prepared based on available system one-lines and usually depict the equipment which is opened by protective relaying (breaker operation) unless specific operating procedures/orders support modeling additional switching. The individual elements of a contingency are validated against equipment defined in the PJM EMS models. Any reported errors are corrected by PJM operators, Reliability Engineers and/or, back-office staff. Contingencies affected, or required, by equipment updates/configuration changes, etc. are usually implemented by back-office staff members just prior to the completion of construction.

5.1.4 CA Solution Quality

As noted above, PJM's contingency analysis program performs full AC analysis of all contingencies. No screening is used. To provide a check or test of the results, results of the contingency analysis program are validated against power flows simulating similar conditions and also by comparing results to actual conditions when appropriate, comparing results pre- and post- switching.

PJM staff members monitor the Contingency Analysis program similar to the State Estimator application. If non-convergent simulations occur, the problems are examined and resolved through appropriate means. PJM worked with our EMS vendor to implement a fairly sophisticated application known as Study Real-Time Maintenance. This application allows back-office staff to capture data and execute real-time applications to re-create the circumstances associated with various problems to assist with problem diagnosis and resolution.

If the CA aborts, an alarm is generated and shown to the operators. In addition, the on-line programs indicate if any of the contingencies simulated do not solve. If the dispatchers cannot resolve the problem, problem resolution is escalated to on-shift reliability engineers and, if the problem is still unresolved, support personnel are called. PJM's Study Real-Time Maintenance package is used to determine if the problem can be repeated and as a debugging tool. PJM staff members seek to understand the reason for all non-converged solutions because any contingency which does not produce results may be an indication that the occurrence of the event will be harmful to the overall system.

As with the State Estimator, PJM also relies upon the daily experiences of dispatchers and reliability engineers to validate that the CA results. Dispatchers and Reliability Engineers are in frequent contact with TOs and adjacent companies. Results from the PJM CA are compared to the CA results produced by the TO and/or other company. If there are differences which cannot be readily explained, support personnel are called to analyze the situation. If no explanation is apparent, PJM support staff work with TO representatives to compare results and models until any the differences can be explained. Depending upon the results of the investigation, appropriate actions are taken.

During normal business hours, support staff members are available. Members of the PJM EMS support staff coordinate their availability to provide call-in support during off-normal business hours. Restoring CA is afforded immediate priority.





Section 6: Data Interfaces

Welcome to the Real-Time Application Support section of the **PJM Manual for Energy Management System Model Updates and Quality Assurance**. In this section, you will find the following information identifying the various interfaces, or downstream databases which require EMS data. These data bases must be updated to assure correlation with EMS models.

The following systems are interfaced to, or derived from the EMS models:

- eDART Functions
- Transmission Outages
- Generator Outages and D Curve updates
- Thermal Equipment Rating Monitor (ratings – see [Appendix A](#) for Term Processing Ratings Data Check List)
- Model Update (Data Collection)
- Tariff Facilities
- EMS Contingency lists
- EMS Flowgates
- EMS SVG one-lines
- EMS SA priorities
- 0 - Not in congestion management
- 1 - Indicates congestion management
- 2 - Indicates security coordination
- 3 - Outage reporting
- 4 - External model security coordination
- Other priorities up to 8 can be assigned
- Market models for LMP and FTR including auxiliary data such as Ratings and Contingency Lists
- Market Settlements (after incorporating known load ownership exceptions, system loads from eMeter and SE loads are reconciled as part of the Market Settlement process.)
- Generator SCADA systems and/or telemetry systems must be interfaced to EMS to provide data for State Estimation if not obtained via ICCP links.



Section 7: Model Contacts

Welcome to the Real-Time Application Support section of the **PJM Manual for Energy Management System Model Updates and Quality Assurance**. In this section, you will find the following information:

See the System Operation Subcommittee (SOS) rosters at <http://www.pjm.com/committees-and-groups/subcommittees/sos.aspx> for contact information.

See the Data Management Subcommittee (DMS) roster at <http://www.pjm.com/committees-and-groups/working-groups/dms.aspx> for contact information.



Appendix A: TERM Processing Ratings Data Check List

What is TERM?

TERM is a front-end ratings database for the PJM EMS. TERM runs periodic checks to verify that the ratings in EMS and in TERM are consistent. The periodic checks are performed at 0600 and 1800 hours. TERM tickets are automatically generated creating tickets matching the EMS ratings when differences are found. No ratings are automatically updated in EMS. As TERM tickets are processed, the status of the tickets changes.

PJM's EMS Network Application programs (State Estimator and Security Analysis) perform the actual limit checking. Data is transferred manually from TERM to Network Applications. PJM operators/REs have the ability to enter ratings data directly into EMS, bypassing TERM. However, automated programs continuously check that all EMS ratings data is consistent with the corresponding TERM data. A Temporary TERM ticket is created with a status of Implemented w/o Approval when the EMS data and TERM data are inconsistent. EMS ratings data is considered the correct data if there is a difference. PJM's EMS has some front-end ratings data, too, saved in an Oracle database known as the Primitive database. TERM also attempts to coordinate with that data.

TERM tickets can be classified as either 'Permanent' or 'Temporary'. Permanent tickets are required to have an Estimated Start Date but not an Estimated End Date since the ratings are 'in perpetuity'. Temporary tickets are required to have an Estimated Start and an Estimated End Date. Neither the Estimated Start or End Date automatically triggers any changes in EMS ratings.

Tickets are submitted to TERM in two ways, via the TERM user interface (UI) or via the EMS/TERM bridge. Ratings change tickets are **Submitted** by users via the UI. PJM staff must **Approve** and **Implement** these Tickets. Once a ticket has a status of Implemented, a formatted file is created which must be loaded **manually** by back-office staff into the EMS. Tickets submitted via the UI can be classified as Permanent or Temporary. (Note: Temporary tickets are usually submitted when cooling fans or oil circulation pumps are forced out until repairs can be made.) TERM performs some automated checking programs. At 0600 and 1800 hours, a full system check is run to identify any ratings data that is NOT consistent. Other checks are performed on a more frequent basis. If the EMS ratings data (called Spectrum) is NOT consistent with the TERM data, an eDART ticket is automatically generated. The revised data is highlighted on the ticket in BOLD. Tickets automatically created by the EMS/TERM bridge are always classified as Temporary with the End Date estimated as Start + 1 Month. These tickets are assigned a status of **Implemented without Approval** and the ratings remain in effect until a new ticket is either processed by PJM staff based on data submitted through the UI or a subsequent check of the EMS finds that the TERM and EMS ratings data disagree.

When a new Permanent ticket replaces existing data, the previous **Permanent ticket is changed to a status of Completed** and any **Temporary tickets are flagged as Restored**.

When a new Temporary ticket replaces an existing Temporary ticket, the existing Permanent ticket continues to exist but the **previous Temporary ticket is changed to a status of Restored**.



Timestamps are associated with TERM tickets as they are submitted. When tickets are created automatically by TERM the Timestamp and the Est Start should be the same except around 6 AM and 6 PM (18). At 6 AM and 6 PM a 'true up' is done which checks that every rating in EMS is consistent with every rating in TERM and no new ratings can be implemented during this check. The timestamp can be different from the Est Start when tickets are manually processed. When creating a ticket in TERM, an Estimated Start is required to be manually entered. The Timestamp indicates when the ratings were actually placed in service. (For example, suppose that a ticket was submitted today with an Estimated Start Date of Monday 8/25 at 8 AM but the ticket actually gets transferred to EMS on Friday 8/22 at 4 PM. The Time Stamp would be Friday 8/22 at 4 PM and the Estimated Start remained 8/25 at 8 AM.)

How to Change Facility Ratings

Background:

Ratings are an essential component for monitoring system conditions and PJM attempts to employ the most accurate ratings information available at all times. Rating data is required whenever new, monitored facilities are installed. In addition, facility ratings may change due to equipment upgrades or other identified reasons (such as temporary cooling equipment malfunctions) It is expected that facility ratings will remain constant over time therefore ratings changes for a given facility should be required infrequently.

All new facility ratings, and changes to existing facility ratings, should be requested by the Transmission Owner (T.O.) through the Thermal Equipment Rating Monitor (TERM). PJM developed the TERM ratings database as part of the eDART application suite. Transmission Owners (T.O.s) are responsible for entering or submitting ratings changes into TERM as 'tickets'. The data on each ticket is recorded and time stamped, creating an audit trail of the information. TERM also creates an electronic file that is used as input to the Energy Management System (EMS).

| It is the T.O.'s responsibility to keep ratings data current by submitting ratings updates throughout the year. T.O.s can, and should, submit changes at any time.

| PJM's modeling practice calls for explicitly modeling and rating all major electrical components to ensure an accurate representation of the grid. That is, line segments (not breaker-breaker) and series devices such as transformers, phase shifter and series devices (reactors or capacitors) are modeled and rated. (Although modeled, shunts capacitors are not limit checked by the PJM EMS and are not rated.) The effect of bus conductors, leads, breakers, switches, line traps, current transformers, protection schemes, etc. that limit capability must be incorporated by the T.O. into an appropriate 'major' component such as a line, transformer, series device (reactor or capacitor) or phase shifter. (When modeled, PJM's EMS simulates breakers and switches as logical devices – open or closed with zero impedance – so no flow can be directly calculated through these devices.) T.O.s are required to identify the appropriate limiting device for each rating when submitting ratings through TERM.

| TERM data is based upon the PJM EMS model. Consequently, ONLY equipment that has been modeled can be viewed and rated. It is imperative that future equipment be modeled well in advance of the equipment in-service date. If the prescribed time-lines in M03A are met, the equipment can not only be switched into service but will also be available for T.O.s



to enter rating data. Generally, this means that new equipment should be in the PJM model more than six (6) months prior to going live (see M03A for discussion of PJM seasonal model builds).

Submitting TERM Tickets

Re-rates and up-rates due to upgrades and/or new construction:

Only authorized T.O. staff members can access TERM (see your CAM administrator). Users select TERM from the eDART application menu to get to the MAIN menu. From the MAIN menu, users should select Create New Ticket and then use the drop-downs provided to select the facility to be initially rated or re-rated. Users should note that the ticket is Permanent (to remain in effect indefinitely) and enter a Start Date to indicate when the new rating will be effective (or the new equipment will be in-service). At their discretion, users can access the default or current ratings data in use at PJM from the soft-keys at the bottom of the page. A 'duplicate' feature is also included to facilitate data entry when submitting ratings for similar equipment with similar ratings.

The T.O. is required to provide justification for the change and for coding in the reason for the change. A reason for the change can be selected from a drop-down menu and users can also manually enter comments. Users are encouraged to make use of the comments field since this information can be used to link the ratings updates to specific construction upgrades, making the approval process more efficient. TERM also requires users to enter the limiting device for each rating provided. A variety of different types of limits can be viewed and selected from the drop-down menu provided (e.g., conductor, bus, wave trap, switch, etc.).

The T.O. is responsible for verifying that all data is correct.

Similar to the process for submitting a transmission outage request, ratings change requests should be made by the 1st day of the month in advance of the expected change (new configuration). Recognizing that this may not be possible under all circumstances, PJM will consider rating change submitted 5 business days prior to the expected implementation date. It is particularly important to submit changes resulting from new installations with this lead time to ensure that new facilities will be monitored when required.

Furthermore, PJM recognizes that ratings are critical to reliable operations and that some rating changes may not be anticipated by the T.O. Consequently, exceptions to this policy can be accommodated upon request by the T.O. If PJM agrees that the changes are reasonable and necessary, the changes will be processed as soon as practical to coincide with the Start Date entered by the user. Users should note that the requested Start Date does not automatically trigger implementation of ratings changes. Users should personally contact PJM staff if it is imperative to expedite ratings implementation.

Temporary Up-Rates or De-Rates

To temporarily up-rate or de-rate a facility due to cooling system problems, etc., T.O.s should enter data into TERM as noted above. However, the ticket should be flagged as a Temporary ticket and an END DATE must be provided. Recognizing that these limits may impact operations, these tickets will be processed as quickly. The T.O. submitting the ticket is urged to contact PJM staff to bring attention to this type of change.



Processing Permanent TERM tickets

Real Time Data Management staff members are responsible for evaluating rating change requests. The TERM queue is checked daily for new entries during normal work days by PJM staff. Ratings are typically checked for the following:

- Ratings are expected to decrease as the temperature index goes up (valid exceptions exist, e.g., differences caused by winter/summer load curves used to derive transformer ratings).
- The same Emergency ratings will populate both the Short-term and Long-term Emergency ratings unless the facility has an approved operating procedure justifying differences between these ratings (e.g., Post-contingency facilities).
- Emergency ratings are expected, but not required, to be higher than Normal Ratings.
- Load Dump ratings are expected, but not required, to be higher than Emergency ratings.
- Rating changes exceeding this guideline may require more scrutiny.
- If the reason for the change is not clear or there are any questions about the requested change, TOs will be required to provide additional justification or information. A comments field is provided.
- Start Date.
- PJM compares the old and new ratings. Generally, rating changes less than a 10% increase or 10% decrease will be approved. If a ratings change greater than 10% increase or decrease is submitted and is not associated with construction or system modifications approved as part of the PJM planning process, additional lead time is required for processing.

Tie-lines are generally defined as 'breaker-to-breaker'. If the facility is a tie-line or in-series with a tie-line without being separated by the protection scheme, PJM will contact the opposite-end owner to advise them of the change and request that they verify the ratings data on their portion of the facility(ies).

Check the monitored equipment priority flag in EMS

(0 - not monitored, 1 – Reliability & Markets., 2- Reliability - BES

3 – Status only for reportable outages, 4 – Reliability External Facilities,

5 – Status External Facilities; 6 – Reliability Non-BES, 7 – Reliability - GSUs)

Note that PJM's implementation of the Bulk Electric System (BES) definition requirements are discussed in Appendix C of this manual.

PJM default conventions for modeling ratings:

- Rate the low-side of 2-winding transformer since metering is usually there
- Rate the high-side of the primary winding of 3-winding transformers
- Never implement ratings on the 1 kV side of 3-winding Ts



- Rate End A only for internal lines
- Rate both End A & End B for tie-lines (owner is responsible for data)

Users should note that PJM specifies how the rating sets will be applied in operations in **Section 2 Thermal Operating Guidelines** in **M3 Transmission Operations**.

The T.O. can view TERM for the status of tickets or view the ticket for the 'Actual Start Date'. The 'Actual Start Date' indicates when the ratings became active in the PJM EMS. If there is no 'actual start date' listed, the change is not active in PJM's EMS.

After implementing the change, Engineering Support circulates a notice to PJM Dispatch, Operations Planning, Transmission Planning and Forward Market Operations staff members informing all concerned that a ratings change was implemented.

T.O.s are expected to coordinate changes to the PJM EMS Ratings data with changes in their internal EMS.

Processing Tie Line Ratings

As noted earlier, PJM prefers that ratings updates, including tie-line ratings, be made before the 1st day of the month prior to the month the change needs to be implemented. In the case of tie-lines, additional coordination and therefore lead-time is required. PJM will consider tie-line rating requests to be late if they are not received 10 business days prior to the expected implementation date.

Ratings changes impacting tie-lines are communicated to both owners and/or the responsible NERC Security Coordinator for the facility to ensure consistent application. Ratings for each end of the facility should reflect the owning company's ratings of the facility as the PJM EMS has the capability of selecting the most limiting ratings from either end of the tie-line. PJM will coordinate implementation of tie-line ratings to ensure that owners of both ends of the line have entered the correct information.

Processing Temporary Rating Changes at PJM:

During off-hours operations, PJM operators can, at their discretion, implement temporary ratings changes directly into the EMS. These changes automatically create Temporary TERM tickets to record the change permanently. Depending upon the circumstances (primarily the duration of the change), PJM operators will instruct back-office staff to review temporary changes during normal business hours. The procedure below discusses temporary ratings:

1. Whenever emergency, short-term (temporary) de-rates are required:
 - a. During normal working hours TO staff should:
 - i. Alert PJM Dispatch to the ratings changes
 1. PJM will manually implement the necessary changes directly into the EMS until the TERM ticket is implemented
 2. PJM will manually updated the ratings as temperature sets change until the TERM ticket is implemented
 - ii. Create a temporary ticket for the facility with the de-rated limits
 - iii. Submit the ticket in TERM and



- iv. Contact ESD staff to process as soon as possible to expedite
 - b. During off-shift hours, TO should:
 - i. Contact the PJM REs/PDs
 - ii. PJM REs/PDs will implement the necessary changes directly into EMS
 - iii. PJM REs/PDs will re-enter appropriate ratings data if the temperature set for TO is changed at PJM
 - iv. Upon start of normal working hours, the TO staff should follow the steps above (1.a.ii to 1.a.iv) for TERM ticket submission.
 - c. To restore the ratings to values after maintenance is completed, the TO should:
 - i. Alert PJM Dispatch to the ratings changes
 1. PJM will manually implement the necessary changes directly into the EMS until the TERM ticket is implemented
 2. PJM will manually updated the ratings as temperature sets change until the TERM ticket is implemented
 - ii. Create and submit a new Permanent ticket with the applicable ratings whenever equipment is restored to 'normal'.
 - iii. TO staff members should consider using the Duplicate feature of TERM for this.
 - iv. If it deemed critical to restore the ratings as soon as possible, TO back office staff should contact ESD staff via phone or eMail to expedite.
2. PJM REs/PDs have the ability to implement ratings updates by direct entry in the PJM EMS. TO staff (both shift and non-shift) should follow the procedures indicated. If there are any problems, the TO should document the situation and forward to PJM for further review of the circumstances.
3. This procedure does not impact processing of Temporary tickets created by TERM due to Dynamic Ratings changes.

Processing Ratings Changes in Short Notice, Emergency Situations

If an emergency rating change is needed, the change can initially be approved via phone call to PJM, however, a TERM ticket must still be entered by the next business day.

Formatted: Font: Not Bold

Bulk Ratings Changes

Ratings are expected to be fairly constant over time with ratings revisions generally implemented on an exception basis. However, PJM will work with T.O.s to develop a plan for implementing changes impacting large numbers of facilities if required.

TERM has been expanded to provide the ability for PJM staff to support bulk ratings uploads. To support this type of effort, T.O.s are required to provide spreadsheets denoting temperature-indexed ratings data for Normal, Long-term Emergency, Short-term Emergency



and Load Dump ratings. Other required data includes the limitation (using an index of approved limitations) associated with the corresponding ratings (e.g., conductor, relay, etc.). The spreadsheets must also provide the PJM EMS B3 Text name to link the equipment to the existing PJM EMS model. Note that it may be necessary for the T.O. to provide additional data including existing ratings as well as calculated differences (in %) between the existing and planned ratings. Also, if available, PJM requests that the T.O. map the B3 Text names to the PSSe bus names used in the latest NERC IDC case. PJM staff will work with the T.O. to assign a descriptive, group name to the spreadsheet and will perform routine data checks as noted earlier in this section prior to implementation. Once the T.O. and PJM arrive at an approved working file, a date will be established to implement the data.

Uploading ratings in bulk requires a significant amount of coordination. For example, bulk ratings updates must be posted to the PJM OASIS prior to actual implementation to ensure that all stakeholders are aware of the changes. Bulk ratings changes are typically scheduled for implementation as part of a PJM EMS database build. However, circumstance may dictate the need for T.O.s to coordinate wholesale ratings changes to comply with changes to congestion management facilities (see M03A for details). PJM expects to receive requests to implement bulk load ratings changes 60 days in advance of the desired implementation date.

Posting Ratings

After each EMS build and during the first week of each month, PJM will post the current ratings data to the PJM OASIS.

Also see Select Transmission Equipment Ratings Monitor (TERM):

<http://www.pjm.com/etools/edart.html>

and

PJM ratings presentation at: Doc #303781



Appendix B: eDART Network Model Training

Go to: <http://www.pjm.com/markets-and-operations/etools/edart/edart-training-presentations.aspx> and Select eDART – Network Model Training (PDF)



Appendix C: Bulk Electric System (BES) Definition Implementation at PJM

Bulk Electric System (BES) Implementation at PJM

PJM is committed to operating the bulk electric system reliably and efficiently at all times. To accomplish this, PJM employs many tools and processes to meet industry standards established to ensure reliability and serve the electric utility industry and its customers.

All transmission facilities operated by PJM fall within one of two NERC Regional Entities - **ReliabilityFirst Corporation** or **SERC Reliability Corporation**. In 2013~~07~~, NERC, ~~through both Regions,~~ approved ~~a~~ definitions of the Bulk Electric System (BES) ~~to be applied uniformly for all Regional Reliability Organizations~~. The definitions ~~focuses~~ on ~~equipment rated 100 kV or higher to establish~~ key elements and equipment ~~in which comprise~~ the transmission ~~(-or-Bulk Electric)-~~ system. ~~In this definition, radial components of the system are excluded, provided they meet the required criteria. The definition also accommodates the inclusion of equipment rated below 100 kV which may impact through transmission components of the electric system. Transmission Owners are responsible for defining BES elements for their systems, as well as, any exclusions or inclusions.~~ To comply with NERC standards, these key elements must be identified and ~~appropriately~~ monitored. ~~As such, each Transmission Owner should notify PJM if any existing elements have been excluded, or any new elements have been included, in its transmission area. In most, but not all, cases, PJM will model these elements explicitly to determine whether the equipment is in service (status) or that for thermal loading or voltage levels which could deviate from recommended limits.~~

~~Although similar, the two definitions are different. The approved definitions which apply to PJM and its members are found at the following websites:~~

~~**ReliabilityFirst Corporation** — www.rfirst.org/Misc/Forms/BESDefinition.aspx~~

~~**SERC Reliability Corporation** — www.serc1.org/documents (NERC filing to FERC — **SERC definition of bulk electric system.pdf**)~~

The following discussion, provided for your information, summarizes PJM's BES implementation approach.

Discussion

PJM has implemented BES as a part of established activities, processes and functions. Facilities included in the BES augment practices originally established to monitor and assess elements of the transmission system associated with administration of the PJM Market and to support NERC reliability coordination (RC) functions.

PJM employs a multi-tiered strategy to ensure system reliability. BES equipment is recognized in all appropriate planning and operations processes and functions. Since a wide array of off-line and on-line transmission studies are performed, facilities included in the BES are under constant review.



Long-term and near-term off-line studies review expected conditions based on load forecasts and include the effects of planned system modifications. Planned maintenance is reflected in the studies where known and applicable. Unplanned and unanticipated outages are simulated via contingency analysis. The off-line studies employ load flow and dynamic stability tools to determine if the projected conditions represent a secure and viable operating condition. If problems are uncovered, solutions are formulated and plans are made to modify the system as required.

As the time frame reduces from long-term to near-term and then to real-time, different analysis tools are employed. To study actual conditions, PJM employs state of the art tools such as State Estimation, Security Analysis, etc. to assess the 'health of the system'. These evaluations run continuously, cycling through ~~almost approximately every one to two-minute~~ ~~of the days~~, 24 hours a day, 7 days a week. These analytical tools determine if unacceptable loading or voltage conditions exist or can be expected for thousands of potential outages. The on-line tools can also be used to help develop remedies to problems that are uncovered and evaluate the efficacy of various options proposed that ensure the system will continue operations in a secure state for the myriad of postulated contingency conditions.

The base conditions and outages/contingencies studied periodically in off-line simulations represent hypothetical conditions consistent with NERC TPL and TOP standards. Events simulating Category A (System Normal), Category B (Loss of single BES element), Category C (Loss of two or more BES elements) and Category D (Extreme events) are simulated as required (defined in NERC TPL standards). These studies assess the system's ability to withstand these types of adverse events. If problems are identified in the analysis, a variety of system adjustments are then employed to counter-act adverse events, well in advance of the actual occurrence of the problem identified.

For on-line studies, equipment maintenance is often represented as part of the base conditions. Events simulating NERC Category A and Category B contingencies are studied continuously by the State Estimator and Security Analysis tools employed in the PJM EMS. Depending upon the type of problem identified, PJM operators are trained to take action to ensure that the system remains reliable. Category C and Category D outages are also simulated on-line as required.

To assess both study and near real-time conditions, facility loading is evaluated as a function of equipment capability. Voltages are also concurrently assessed as a function of acceptable high and low limits. Voltage changes which occur in response to the simulated contingencies are also compared to specified limits. Thousands of hypothetical contingencies (outages) are investigated to determine if any BES elements will be adversely impacted.

Although not comprehensive, the following list cites several types of key studies that are routinely performed:

- Off-line, long-term, Regional Transmission Expansion planning studies;
- Generation Deliverability planning studies;
- Seasonal Operations Analysis studies;
- Short-term (daily to 6 months) Outage Coordination studies;
- Very near-term studies during peak load conditions; and,

Formatted: Indent: First line: 0"



- Periodic State Estimation and Security Analysis by both PJM and TOs

(Note that PJM will also work with the staff of member companies to investigate circumstances and conditions which warrant special attention.)

Equipment included in the BES

Electrical Models

PJM uses well established models of lines, series devices, shunts, transformers, phase shifters and generators in the various off-line and real-time studies. Due to the nature of the calculations used to evaluate electric system models, it is not always feasible to directly monitor some components of the BES. For instance, in the real-time models, the current status of switches and breakers is automatically used by the software to develop 'bus' models of the system at a given point in time based on telemetered status information. This renders an accurate 'bus' representation of current system conditions reflecting current maintenance activities, as well as, prevailing load and generation patterns. Status information is also used to simulate or monitor the effects of switched BES shunt devices such as capacitors and reactors in PJM operation's models. For off-line studies, it is generally presumed that switches and/or breakers are in their normal open or close position and 'bus' models are derived by the user. If maintenance or other 'abnormal' system conditions are modeled, the user must adapt the model accordingly.

PJM's focus is on the wide-area network, concentrating on the loading of major equipment, such as lines, transformers, series devices, phase shifters, generators, etc. There are several reasons for carefully selecting components to model (or not model). PJM's on-line SE/SA tools employ lumped parameter models. Hence these tools do not directly calculate flows through switches and breakers, etc. as they are near zero-impedance devices. There are other, very low impedance connections such as drops, loops, taps and bus sections that also do not lend themselves to explicit real-time models with the available tools—.

It can be demonstrated that representing very low impedance elements can cause numerical instability. The addition of numerous very low impedance connections would also tend to reduce throughput by increasing State Estimator and Contingency Analysis computing time. For these reasons, PJM does not generally represent very low impedance connections and devices in real-time analysis. Given-

current tools. However, it is recommended that very low impedance devices can be reviewed in off-line studies to assess. ~~As part of the Transmission Owner's planning process,~~ all possible substation configurations ~~are to be reviewed to determine if they can be fully loaded during anticipated peak load conditions as part of the Transmission Owner's planning process.~~ If loading problems of specific, very low impedance devices are uncovered in the TO's analysis, the TOs should make appropriate system modifications to alleviate the problem. If insufficient lead time exists to mitigate the problem, PJM will work with the TO to develop appropriate tools, alarms and procedures to reliably monitor specific equipment as an interim measure. TOs will be responsible for providing data and/or information to support monitoring the facilities in question should the need arise (as described in Manual 01 Control Center Requirements).

There may also be special modeling considerations which obviate the need to directly monitor select equipment in the EMS model. These special considerations may include:

- Individual turbines in a 'wind farm';



- Phase Shifters;
- DC lines; and,
- Other non-synchronized facilities (e.g., 25 cycle railroad equipment).

This equipment may be represented as either a load ([sink](#)) or generator ([source](#)) for on-line security purposes and may not be explicitly modeled as part of the BES. Maximum loading conditions are pre-determined through off-line study. Flows are restricted in the model to the prescribed load and generation levels. [For on-line models, windfarm generation is modeled by simulating 'aggregate' generators at points connected to the Bulk Electric System via step-up transformers.](#)

Ratings for the modeled equipment are derived and provided by the transmission owner. These are applied to the 'major equipment' noted above. Typically, limits applied to the modeled lines and transformers are modified to account for 'line or transformer drops', 'bus-bars', etc., since these are essentially zero impedance devices and are not readily modeled. [Auxiliary equipment components are not explicitly modeled by PJM \(e.g., CTs, PTs, wave traps and relays\). The impact of these devices is reflected in the limits applied to modeled equipment and to establish the contingencies to be evaluated. Since PJM requires metering for real-time models, power outputs from the plant are accurate and consistent with the aggregate plant output at all times.](#)

Since equipment can be monitored for a number of different reasons, it is necessary to categorize components of the overall electric system monitoring effort. The various types of monitored equipment are categorized as:

- 0 – Modeled but not monitored
- 1 – Equipment participating in Markets & Reliability*
- 2 – Reliability - BES facilities not in Markets & Reliability**
- 3 – Modeled and monitored for Status only
- 4 – External facilities modeled and monitored
- 5 – External facilities modeled and monitored for Status only
- 6 – Reliability - Non-BES facilities modeled and monitored at TO request
- 7 – Generator Step Up transformers***

* Although the majority of these facilities are also classified as BES, this category of equipment also includes some Non-BES facilities less than 100 kV.

** Includes facilities PJM monitors as NERC Reliability Coordinator.

***Generator step-up (GSU) transformers, initially sized to support maximum output of the generators they connect, are analyzed as part of PJM's off-line, Generator Deliverability studies ~~and are not considered to be BES elements themselves.~~ Expected GSU loading is reviewed again whenever unit or plant modifications are planned. For on-line studies, PJM explicitly models the GSUs when it is used to connect a BES generator to the network. [PJM models wind farms as aggregated units connected to the collector transformers which interconnect to the electrical grid at 100+ kV.](#) If the GSU does not connect a BES generator



to the network or if the unit is external to PJM the GSU may be implicitly modeled. Thermal ratings are applied to GSU which connect BES generators to the network.

Any BES facility limitations which cannot be modeled or approximated readily by PJM can typically be monitored by adjusting major equipment limits. When this is not feasible, PJM works with TOs to develop appropriate mechanisms to avoid potential problems.

PJM's analysis of the electric system is not limited to equipment identified as part of the BES. In addition to fully integrating, qualifying BES electric system components into all analyses, PJM also models and monitors additional system components. These components may be required for operation of the PJM Reliability & Market or for security analysis of non-BES and/or non-PJM Market facilities. That is, BES elements are a subset of all the components are modeled and monitored as members of the PJM Monitored Facilities list.

Components of the PJM Monitored Facilities list, including modeled BES facilities, are published on the PJM web-site at:

<http://www.pjm.com/markets-and-operations/transmission-service/transmission-facilities.aspx>

For clarity, it is important to note that to ensure high fidelity models and accurate simulations of the actual electric system; equipment that is not included in PJM Monitored Facilities is also modeled. This equipment can represent either internal or external (non-PJM) facilities. These facilities are generally not listed on the web-site.

BES Protective Equipment

PJM routinely completes off-line planning studies to investigate normal conditions, single contingencies, as well as, the impact of the simultaneous loss of multiple BES elements and delayed clearing and/or failures of interrupting devices. Appropriate measures are taken to upgrade or mitigate the circumstances when problems are identified. PJM also studies breaker duties and assesses Dynamic Stability via off-line studies.

The impact of the action of protective equipment, including the protection associated with or impacting BES facilities, is, incorporated into near-term and real-time studies by constructing contingencies to simulate expected operations to isolate problems from the system. In addition to studying Normal or Steady-State operating conditions to ensure a secure operating state, PJM constructs and studies outages for periodic evaluation (about 2 minutes). These outages simulate the operation of primary protection schemes employed by the TOs (consistent with NERC Category B). This is substation specific and presumes that protective relays will operate as designed to open the nearest fault clearing devices. Since the PJM EMS uses real-time status to determine connectivity, the impacts of abnormal opened and closed switches and breakers is automatically reflected in the security analysis models. TOs are responsible for alerting PJM if primary relay schemes are disarmed and/or alternate protection schemes are in place. Using this information, PJM will adjust the periodically monitored contingencies to reflect these conditions.

Bus faults and failures of protective devices (Category C and Category D) can also be modeled and reviewed on an ad hoc basis via the real-time analysis tools.



Revision History

Revision 07 (07/10/2013):

- [Engineering Support to Model Management, John Baranowski, mgr](#)
- [Responsibility for ratings to Real Time Data Management, Chris Smart, mgr](#)
- [References from DMWG to DMS](#)
- [Numerous edits throughout the entire document for clarity](#)
- [Section 1.2, specifies auxiliary loads, generator step-ups & telemetry model requirements to support BES](#)
- [Inserted new section 1.7 discussing TSA and data requirements](#)
- [Section 2.2 & 3.1 added references to transient stability data requirements including contingency definitions and clearing times in sections involving data requirements](#)
- [Section 3.3 defines emergency ratings as capability up to 4 hours and emergency ratings as capability up to 15 minutes](#)
- [Section 3.3 eliminated statement that 3% separation is required between emergency & load dump](#)
- [Added new Exhibit 5 illustrating the level of model detail in the overall PJM EMS model](#)
- [Added Solar Park to generator naming conventions in Section 3.5](#)
- [Provided reference locations for LMP and FTR load flow data in section 4.2 Bus Connectivity and Engineering Data](#)
- [Inserted new section 4.4 explaining Tie-line cut-in process requirements](#)
- [Section 4.5 \(was 4.4\) revised to describe Cut-in flags & reports](#)
- [Section 5.1 removed references to theory and reality](#)
- [Section 5.1.2 clarified to state that PJM's SE solution & dumps are provided to TOs upon request](#)
- [In Appendix A, TERM Processing Data Ratings Check List removed references to forced differentials between Normal, Emergency and Load Dump ratings \(see Section 3.3 changes\)](#)

Revision 06 (01/24/2011)

Section 2.2 was expanded to include the physical location of substation equipment, including state and GPS coordinates.

The Electrical Models section of Appendix C 'Bulk Electric System (BES) Implementation at PJM' was modified to discuss modeling and monitoring very low impedance equipment.



Appendix A, TERM processing ratings data information concerning processing of temporary ratings changes was expanded.

Revision 05 (05/03/2010)

Appendix A 'TERM Processing' was re-written and re-named 'Processing Ratings in TERM'. An explanation of new TERM Bulk Upload capability scheduled for implementation 2Q10 was also included.

Appendix C 'Bulk Electric System (BES) Implementation' revised as follows:

- Removed indents from section headers to improve readability
- Added special modeling discussion to the Electrical Models section
- Inserted 'an' before ad hoc in last sentence

Revision 04 (05/05/2009)

Denoted David Schweizer as manager of Power System Coordination Department, formerly Ken Seiler

Added Appendix C Bulk Electric System (BES) Definition Implementation at PJM. A reference to the appendix was placed in Section 2 under the heading PJM Bulk Electric Transmission Facilities.

In Section 3, PJM Ratings Data (Thermal Equipment Ratings Monitor – TERM), a paragraph was added to reference the ratings update procedures found in M3, Transmission Operating Guidelines.

In Appendix A, TERM Processing Ratings data check list revised the monitored facility flag descriptions to be consistent with PJM's BES Implementation. Also noted that PJM's implementation of the Bulk Electric System definition requirement is outlined in M03 Appendices.

Revision 03 (09/25/2008)

Section 2 Model Information and Transmission Facility Requirements was revised to remove duplication between M3, Section 1 and M3A, Section 2.

Also clarified that the terms Congestion Management and Reliability & Markets are interchangeable.

Added Background and Highlights of what TERM is and How It is Used at PJM to Appendix 1

Updated references to other manuals.

Revision 02 (08/14/2008)

BES Implementation

The References section was updated to clarify that this manual references M-14D, Generator Operational Requirements.

Terminology and references throughout the document were modified to ensure compliance with recently developed **ReliabilityFirst Corporation & SERC Reliability Corporation** definitions of the Bulk Electric System (BES). Note that the system facilities modeled, managed and monitored by PJM include, but are not limited to, those defined by the **ReliabilityFirst Corporation & SERC Reliability Corporation** definition.



| References to PJM model responsibilities throughout the document were modified to reflect current organizational structures/names.

| Section 1 was updated to clarify telemetry requirements for load-tap-changing (known as LTC or TCUL).

| Section 4 was updated to clarify that the transmission owner is responsible for verifying modifications to their models are accurate using feedback provided by PJM.

Revision 01 (05/15/2007)

Changed the name of author from Mike Bryson to Ken Seiler.

Revision 00 (03/01/07)

This revision is the preliminary draft of the PJM Manual for Energy Management System (EMS) Model Updates and Quality Assurance (QA).