

MARCH 20th 2024 MRC Draft M14B for LTRTP –

PJM Manual 14B:

PJM Region Transmission Planning Process

Revision: 5X

Effective Date: XXXX XX, 2024

Prepared by
Transmission Planning Department

PJM © 2024



Table of Contents

Approval2

Current Revision.....2

Introduction.....2

 About PJM Manuals.....2

 About This Manual.....2

 Intended Audience2

 References.....2

 Using This Manual2

 What You Will Find In This Manual2

Section 1A: Critical Energy Infrastructure Information (CEII).....2

 1A.1 CEII Definition2

 1A.2 Introduction.....2

 1A.2.1 General Intent.....2

 1A.2.2 Examples of CEII.....2

 1A.2.3 Rules When CEII Includes Confidential Member Information2

 1A.2.4 Reservation of Rights to Amend CEII Rules.....2

 1A.3 PJM CEII Rules2

 1A.3.1 CATEGORIES OF PJM CEII REQUESTERS PROCEDURES.....2

 1A.3.1.1 Authorized Entities Procedures2

 1A.3.1.2 Federal Agency and NERC Procedures2

 1A.3.1.3 PJM Authorized State Commission2

 1A.3.1.4 Procedures Applicable to Other CEII Requests.....2

 1A.3.2 PJM CEII Handling2

Section 1: Process Overview2

 1.1 Planning Process Work Flow.....2

 1.2 TEAC and Subregional RTEP Committee and Related Activities2

 1.3 Planning Assumptions and Model Development2

 1.3.1 Reliability Planning (including Operational Performance and Public Policy Planning).....2

 1.3.2 Economic Planning2

 1.3.3 FERC Form No. 7152

 1.3.4 Supplemental Projects2

 1.4 RTEP Process Key Components.....2

 1.4.1 Key Process Drivers2

 1.4.1.1 Baseline reliability analyses2

 1.4.1.2 Economic analyses (Market Efficiency studies).....2

 1.4.1.3 Operational performance issue reviews and accompanying analyses .2

 1.4.1.4 FERC Form No. 7152

 1.4.1.5 Supplemental Project Planning2

 1.4.1.6 Customer-Funded Upgrade analyses2

1.4.1.7 The Final RTEP Plan	2
1.4.1.8 Maintaining reliability associated with critical substations.....	2
1.4.2 Coordination of Baseline Upgrades, Supplemental Projects and Customer-Funded Upgrades	2
1.4.2.1 When a Need is identified in the Attachment M-3 Process that requires development of a Supplemental Project (not yet included in RTEP base case)	2
1.4.2.2 When a Supplemental Project is submitted for inclusion in the Local Plan (not yet included in RTEP case)	2
1.4.2.3 When a baseline upgrade is included in RTEP base case (in a prior RTEP cycle) and a Supplemental Project or Customer-Funded Upgrade is identified which interacts with the need for the baseline upgrade.....	2
1.4.2.4 Incorporation of EOL Needs into the RTEP	2
1.4.3 Addition and Removal of System Projects or Upgrades from the RTEP Base Cases.....	2
1.5 Planning Criteria	2
1.5.1 Reliability Planning.....	2
1.5.2 Market Efficiency Planning.....	2
1.5.3 FERC Form No. 715 Planning	2
1.5.4 Supplemental Project Planning.....	2
Section 2: Regional Transmission Expansion Plan Process	2
2.1 Transmission Planning = Reliability Planning + Market Efficiency+ FERC Form No. 715 + Public Policy + Supplemental Project Planning	2
2.1.1 Multi-Driver Approach	2
2.1.2 Reliability Planning.....	2
2.1.3 Market Efficiency Planning.....	2
2.1.4 Public Policy Planning.....	38
2.2 The RTEP Process Drivers.....	40
2.3 RTEP Reliability Planning.....	43
2.3.1 Establishing a Baseline.....	43
2.3.2 Baseline Reliability Analysis	43
2.3.3 Near-Term Reliability Review	44
2.3.4 Reference System Power Flow Case	45
2.3.5 Contingency Definitions	46
2.3.6 Baseline Thermal Analysis.....	46
2.3.7 Baseline Voltage Analysis.....	46
2.3.8 NERC P3 and P6 “N-1-1” Analysis	47
2.3.9 Load Deliverability Analysis	50
2.3.10 Generator Deliverability Analysis	50
2.3.11 Spare Equipment Strategy Review	51
2.3.12 Baseline Stability Analysis	51
2.3.13 Extreme Event Review.....	51
2.3.14 Long-Term Reliability Review	52
2.3.15 Stakeholder review of and input to Reliability Planning	54
2.3.16 Corrective Action Plan	55

2.4 RTEP integrates Baseline Assumptions, Reliability Upgrades and Request Evaluations	56
2.5 RTEP Cost Responsibility for Required Enhancements	57
2.6 RTEP Market Efficiency Planning	57
2.6.1 Market Efficiency Analysis and Stakeholder Process	58
2.6.2 Determination and evaluation of historical congestion drivers	58
2.6.3 Determination of projected congestion drivers and potential remedies	58
2.6.4 Evaluation of cost / benefit of advancing reliability projects	59
2.6.5 Determination and evaluation of cost / benefit of potential RTEP projects specifically targeted for economic efficiency	59
2.6.6 Determination of final RTEP market efficiency upgrades	60
2.6.7 Submitting Proposals	62
2.6.8 Ongoing Review of Project Costs	62
2.7 Evaluation of Operational Performance Issues	62
2.7.1 Operational Performance Metrics	63
2.7.2 Probabilistic Risk Assessment of PJM 500/230 kV Transformers	63
2.8 End of Useful Life Issues	64
2.9 Critical Substation Planning Analysis	64
Attachment A: PJM Baseline Reliability Upgrade Cost Allocation Procedures	66
A.1 Purpose	66
A.2 Scope	66
A.3 Schedule 12 Cost Allocation Process for Baseline Transmission Reliability Upgrades	66
A.3.1 RTEP Baseline Reliability Upgrade Cost Allocation	66
Attachment B: Regional Transmission Expansion Plan—Scope and Procedure	70
B.1 Purpose	70
B.2 Scope	70
B.3 Procedure	72
B.4 Scenario Planning Procedure	76
Attachment C: PJM Deliverability Testing Methods	79
C.1 Introduction	79
C.1.1 Purpose of Deliverability Requirements	79
C.1.2 Types of Deliverability Requirements	79
C.2 Load Deliverability	80
C.2.1 Overview of Load Deliverability	80
C.2.1.1 Purpose of Load Deliverability	80
C.2.1.2 Locational Deliverability Areas	80
C.2.1.3 General Assumptions	81
C.2.1.4 General Procedures	81
C.2.2 Current Locational Deliverability Area Definitions	82
C.2.3 Base Case Development	86

C.2.3.1 Load Deliverability Area Assumptions	86
C.2.3.2 Dispatch for Load Deliverability Study Area	87
C.2.3.3 Dispatch for PJM Areas not in a Capacity Emergency	88
C.2.3.4 Dispatch for non-PJM Areas not in a Capacity Emergency	88
C.2.4 Capacity Emergency Transfer Objective (CETO) Procedure	89
C.2.5 Capacity Emergency Transfer Limit (CETL) Procedure	89
C.2.5.1 Procedure for Determining Load Deliverability Facility List	89
C.2.5.2 CETL Determination	91
C.2.6 CETO/CETL as an Input to RPM	92
C.3 Deliverability of Generation	92
C.3.1 Generator Deliverability Procedure	93
C.3.1.1 Introduction	93
C.3.1.2 Study Objectives	93
C.3.1.3 General Procedures and Assumptions	93
C.4 Long-Term Deliverability Analysis	103
C.4.1 Base Case Development	104
C.4.2 Analysis	105
C.4.3 Linear Extrapolation	106
C.4.4 Long-Term Upgrades	108
Attachment D: PJM Reliability Planning Criteria	110
Attachment D-1: Load Loss Definitions	112
Attachment E: Market Efficiency Analysis Economic Benefit / Cost	116
Ratio Threshold Test	116
E.1 Total Annual Enhancement Benefit	116
E.2 Total Annual Enhancement Cost	119
Attachment F: Determination of System Operating Limits used for	120
planning the Bulk Electric System	120
Attachment G: PJM Stability, Short Circuit and Special RTEP Practices	125
and Procedures	125
G.1 Stability	125
G.2 Dynamics Procedures	126
G.2.1 Dynamics Reference Cases	126
G.2.2 Dynamics Analysis	127
G.3 New Services Queue Stability Study Procedures	129
G.3.1 Stability Data Requirements	130
G.3.2 New Services Queue Stability Study Scope and Process	130
G.4 System Stability Studies	131
G.4.1 NERC P3 and P6 "N-1-1" System Stability Studies	132
G.5 Impact Study Procedures Applicable to Wind Turbine Analyses	134
G.5.1 Wind Project Final Impact Study Data	135
G.5.2 Wind Project LVRT Requirements	135

G.5.3 Wind Project Reactive Power Modeling	135
G.6 Stability Analyses of Stability Sensitive Local Areas in PJM.....	136
G.7 Short Circuit	136
G.8 Nuclear Plant Specific Impact Study Procedures	137
G.9 Appendix to Manual 14B Attachment G.....	138
G.9.1 Testing of Transmission Owner Criteria	139
G.9.2 Nuclear Station Testing.....	139
G.9.3 BG&E Specific Criteria	140
G.9.4 ComEd Specific Criteria	140
G.9.5 PPL Specific Criteria	141
G.9.6 Implementation of the NPIR for Planning Analysis	141
G.10 NERC Standard PRC-023 – Transmission Relay Loadability.....	141
G.11 PJM Capacity Import Limit Calculation Procedure.....	143
Attachment H: Power System Modeling Data	147
H.1 Power System Modeling Data	147
H.1.1 Load Flow Analysis Models.....	147
H.1.2 Load Flow Modeling Requirements.....	148
H.1.3 Submittal of Load Flow Data	149
H.1.4 Short Circuit Analysis Models.....	150
H.1.5 Stability Analysis Models.....	151
Attachment I: Steady State & Stability Performance	
 PlanningEvents	155
Attachment J: Checklist for New Equipment Energization Process	161
Revision History	164

Table of Exhibits

Exhibit 1: Reliability Planning Cycle.....	33
Exhibit 2: 24-Month Market Efficiency Cycle.....	35
Exhibit 3: Modeling Rights for Merchant Transmission Facilities.....	94
Exhibit 4: Illustration of Base Reliability Scenario Development Considerations & Assumptions	
Exhibit 5: Interpolating Transmission Loadings Over tThe Planning Horizon.....	105

Approval

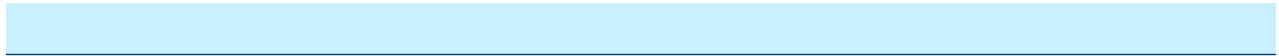

Approval

Approval Date: 12/27/2021

Effective Date: 7/1/2023

Sami Abdulsalam, Sr. Manager

Transmission Planning

Current Revision

Revision 53 (7/1/2023):

- Introduction: Revised terminology to align with new tariff language, updated references
- Section 1A.3.1.1: Updated terminology
- Section 1.1: Updated terminology/references
- Section 1.4.1.6: Updated terminology/references
- Section 1.4.3: Updated terminology
- Section 2.1.1.1: Updated terminology/references
- Section 2.2: Updated terminology, revised note to clarify potential impact of generation retirements
- Section 2.3.1: Updated terminology
- Section 2.4: Updated terminology, streamlined language
- Section 2.5: Updated reference
- Attachment B, B.3: Updated terminology/references
- Attachment B, B.4: Updated terminology
- Attachment C: Updated terminology throughout
 - C.3.1.3:
 - 2: Removed statement referencing serial queue process
 - 5a: Revised statement on commercial probability to align with IPRTF material
- Attachment G: Updated terminology/references throughout, updated stability language to align with current process
- Attachment H.1.2: Updated terminology

Revision 52 (12/1/2022):

- Updates to the Generator Deliverability Procedure to implement block dispatch
 - New Exhibit 4 – Block Dispatch for RTEP Cases
 - Section 2.3
 - Sections 2.3.11 (Light Load) and 2.3.13 (Winter Peak) removed, now addressed in 2.3.10

-
- o Attachment B

-
- o o Attachment C.3
 - o o Attachment D-1
 - o Attachment D-2 and D-3 removed, now addressed in C.3
 - Section 1A.3.2 added to clarify PJM CEII Handling

Introduction

Welcome to the **PJM Region Transmission Planning Process Manual**. In this Introductory Section you will find information about PJM manuals in general, an overview of this PJM Manual in particular and information on how to use this manual.

About PJM Manuals

The PJM Manuals are the instructions, rules, procedures, and guidelines established by PJM for the operation, planning, and accounting requirements of the PJM RTO and the PJM Energy Market. The manuals are grouped under the following categories:

- Transmission
- PJM Energy Market
- PJM Regional Transmission Expansion
- Reserve
- Accounting and billing
- PJM administrative services

For a complete list of all PJM manuals, go to the Library section on PJM.com.

About This Manual

The **PJM Region Transmission Planning Process Manual** is one of the PJM manuals in the PJM Regional Transmission Expansion group. This manual focuses on the process for planning baseline expansion facilities under the PJM Region Transmission Planning Process. Capitalized terms not defined as they are used have the meaning defined in the PJM's Open Access Transmission Tariff (OATT) and in the Operating Agreement (OA.)

This **PJM Region Transmission Planning Process Manual** consists of two sections and related attachments. All sections and attachments are listed in the Table of Contents.

Note:

While the PJM Manuals provide instructions and summaries of the various rules, procedures and guidelines for all phases of PJM's planning process, the PJM Operating Agreement and the PJM Open Access Transmission Tariff (OATT) contain the authoritative provisions.

Intended Audience

The intended audiences for this PJM Region Transmission Planning Process Manual include:

- Generation and Transmission Project Developers and their engineering staff

Note:

The term "Transmission Project Developer", as defined in the PJM Open Access Transmission Tariff, refers to an entity that submits a request to interconnect or add Merchant Transmission

Facilities to the Transmission System or to increase the capacity of Merchant Transmission Facilities interconnected with the Transmission System in the PJM Region rather than an existing Transmission Owner on the PJM System that installs Regional Transmission Expansion Plan “baseline,” “economic,” “system performance” or public policy projects. An existing Transmission Owner also installs “Supplemental Projects” pursuant to Tariff, Attachment M-3. . Prior to PJM’s interconnection reforms effective January 3, 2023, the Interconnection Service Agreement (ISA) was the form agreement included in the Tariff used to facilitate interconnection to PJM’s transmission system, which used the term “Interconnection Customer” to refer to generation interconnection customers, similar to the Project Developer. While the ISA is no longer used for interconnection to the transmission system, pre-existing ISAs remain active. On and after [provide Transition Date], the Generator Interconnection Agreement (GIA) is used as the form agreement included in the Tariff to facilitate interconnection to PJM’s Transmission System. In addition, PJM will use a Wholesale Market Participation Agreement (“WMPA”) to facilitate the interconnection of a project that intends to engage in Wholesale Transactions in PJM’s markets and physically interconnect its Generating Facility at a local distribution or sub-transmission facility that is not at the time subject to the Tariff. Forms of both the GIA and WMPA are found in Tariff, Part IX.

- Transmission Owners, nonincumbent transmission developers and their respective engineering staff
- Federal and state regulatory bodies
- PJM Members
- PJM staff

References

There are other PJM documents that provide both background and detail on specific topics that may be related to topics in this manual. References with related information include:

- [PJM Manual 1: Control Center and Data Exchange Requirements](#)
- [PJM Manual 2: Transmission Service Request](#)
- [PJM Manual 3: Transmission Operations](#)
- [PJM Manual 14C: Generation and Transmission Interconnection Facility Construction](#)
- [PJM Manual 14D: Generator Operational Requirements](#)
- [PJM Manual 14H: New Service Request Process](#)
- [PJM Manual 21: Rules and Procedures for Determination of Generating Capability](#)

Using This Manual

We believe that explaining concepts is just as important as presenting procedures. This philosophy is reflected in the way we organize the material in this manual. We start each section with an overview. Then we present details, procedures or references to procedures found in other PJM manuals. The following provides an orientation to the manuals’ structure.

What You Will Find In This Manual

- A table of contents.
- An approval page that lists the required approvals and a brief outline of the current revision.
- This Introduction and sections containing the specific transmission planning process details including assumptions, criteria, procedures and stakeholder interactions.
- Attachments that include additional supporting documents, forms, or tables.
- A section at the end detailing all previous revisions of this PJM Manual.

Section 1A: Critical Energy Infrastructure Information (CEII)

1A.1 CEII Definition

PJM adopts the Federal Energy Regulatory Commission’s (“FERC” or “Commission”) definitions of Critical Energy Infrastructure Information (“CEII”) and Critical Infrastructure at 18 CFR §388.113 (c) as follows:

- Critical Energy Infrastructure Information means specific engineering, vulnerability, or detailed design information about proposed or existing critical infrastructure that:
 - o Relates details about the production, generation, transportation, transmission, or distribution of energy;
 - o Could be useful to a person in planning an attack on critical infrastructure;
 - o Is exempt from mandatory disclosure under the Freedom of Information Act, 5 U.S.C. 552; and
 - o Does not simply give the general location of the critical infrastructure.
- Critical Infrastructure means existing and proposed systems and assets, whether physical or virtual, the incapacity or destruction of which would negatively affect security, economic security, public health or safety, or any combination of those matters.

1A.2 Introduction

1A.2.1 General Intent

PJM’s intent is to provide a process for eligible recipients to access CEII consistent with the Commission’s standards for handling CEII material. PJM information that contains CEII can only be obtained by complying with PJM’s CEII authorization process.

1A.2.2 Examples of CEII

The Commission considers certain information to be CEII. For example, information filed in the FERC-715, Part 2, Part 3, and Part 6 (<http://www.ferc.gov/legal/ceii-foia/ceii.asp>) is considered by the FERC to be CEII. This information contains electrical models, detailed one-line diagrams and analysis of the filer’s actual transmission system including potential weaknesses of the filer’s transmission system. PJM treats all such power flow and associated system modeling data as CEII. This includes all power flow models that are developed using or including data and related information used in transmission system analysis such as contingency and monitored element files. Power flows specifically configured for short circuit analysis that do not contain load and generation dispatch are not considered CEII. Other information may also qualify as CEII under the Commission’s definitions.

1A.2.3 Rules When CEII Includes Confidential Member Information

Regarding all types of PJM information, additional consideration must be given to whether or not PJM received or originated the information as confidential information prior to decisions regarding its release. Confidential information is governed by the PJM Operating Agreement Section 18.17 and the Open Access Transmission Tariff Sections 222-223. Certain information

is a combination of CEII information filed or provided by a number of “owners” and may include confidential information. To the extent CEII material sought from PJM includes confidential information of a PJM Member, including PJM Transmission Owners or Generation Owners, PJM will require the requester to demonstrate the affected members give consent to the release of the confidential information contained within the CEII material by PJM to comply with the Tariff and Operating Agreement. Power flows may, but generally do not, contain confidential information. Some PJM power flows are special cases that contain both confidential information and CEII. For example, PJM power flows originating from system operations and used for near term operational studies often contain confidential information in addition to CEII. Confidential information of members, if any, may be redacted prior to release of CEII if the CEII requester is unable to demonstrate to PJM that the affected members give consent to the release of the confidential material.

1A.2.4 Reservation of Rights to Amend CEII Rules

PJM reserves the right to revise its process from time-to-time, to limit access to CEII as may be appropriate in any specific instance in accordance with PJM’s manual revision procedures posted on PJM.com.

1A.3 PJM CEII Rules

1A.3.1 CATEGORIES OF PJM CEII REQUESTERS PROCEDURES

1A.3.1.1 Authorized Entities Procedures

The process to request CEII from PJM is as follows for an employee or authorized agent/consultant of : (i) a PJM Member; (ii) a PJM Transmission Owner; (iii) a PJM Generation Owner or operator of generating units in the PJM Region; (iv) a NERC registered Transmission Owner/Operator; (v) a PJM Project Developer; (vi) another RTO or similar independent system operator recognized by the Federal Energy Regulatory Commission; (vii) a NERC Planning Coordinator or Transmission Planner; (viii) a Non-incumbent Developer pre-qualified to be a Designated Entity pursuant to Schedule 6 of the Operating Agreement; or (viii) a natural gas local distribution company and/or a natural gas pipeline operator serving customers within the PJM Region (individually “Authorized Entity” and together “Authorized Entities”). The process outlined below allows for individual employees or individual authorized consultants of Authorized Entities to obtain CEII. PJM’s procedures set forth below allow an organization to submit requests on behalf of multiple individuals within Authorized Entities.

Except in the case of Organizational CEII requests described below, each individual requester of CEII from employees or authorized agents/consultants of Authorized Entities must complete a PJM CEII Request Form and must execute the appropriate PJM CEII Nondisclosure Agreement (“NDA”). Employee, authorized agent or an Authorized Entity must submit a PJM CEII Authorization Form (in addition to the requester’s completed PJM CEII Request Form and appropriate PJM CEII NDA) that identifies each individual agent/consultant who may make individual requests for PJM CEII on behalf of such entity.

Once the CEII requester has been verified by PJM as a legitimate CEII requester (i.e., a legitimate employee or authorized consultant of one of the organizations listed in paragraph 1A.3.1.1 above), such CEII requester may obtain CEII.

Organizational CEII Requests: Authorized Entities may enter into an organizational agreement with PJM which will allow the receiving organization to share CEII information under the terms of an applicable PJM CEII NDA however, PJM may use other forms of organizational CEII NDAs as appropriate. Such organizational NDA will require individual recipients of CEII material to be listed and sign an attachment to the NDA which will require each individual to acknowledge his or her understanding of the restrictions on the use of CEII or further disclosures except as allowed under the terms of the organizational NDA. Each organization is required to keep the list of authorized individual recipients up to date and notify in PJM in writing of any changes to the status of the authorized individual recipients in accordance with the applicable NDA.

1A.3.1.2 Federal Agency and NERC Procedures

If the requester of CEII material is a representative of FERC, Department of Energy, Department of Homeland Security, NERC or a NERC Regional Entity (e.g. RF, SERC, etc.), PJM will release the information if PJM confirms that the requestor (requestors) are employees of these agencies and the CEII material is subject to the agencies rules of procedures applicable to CEII.

1A.3.1.3 PJM Authorized State Commission

The process to request CEII from PJM is as follows for an employee of a PJM Authorized State Commission: Each individual requester of CEII must complete a PJM CEII Request Form and must execute a PJM CEII Government NDA located on the PJM website.

- After such CEII requester has been verified by PJM as a legitimate CEII requester (i.e., a legitimate employee of one of the governmental organizations listed above), such CEII requester may obtain the requested CEII.

1A.3.1.4 Procedures Applicable to Other CEII Requests

The process to request CEII from PJM is as follows for any other requester seeking CEII from PJM:

- Each individual requester of CEII must establish or have a PJM.com account. A PJM.com account can be created here: <https://accountmanager.pjm.com/accountmanager/pages/public/new-user.jsf>
- Each individual requester of CEII must then complete a PJM CEII Request Form and must execute an appropriate PJM CEII NDA. The PJM CEII NDA form will come up when a link to CEII is clicked on many places on PJM.com. There are prepopulated PJM CEII Request Forms at various locations throughout PJM.com. A blank generic PJM CEII Request Form is located at: <https://www.pjm.com/library/request-access.aspx>. Where the individual requester of CEII is an authorized agent/consultant for another entity, then an authorized employee of such entity must submit a PJM CEII Authorization Form (in addition to the requester's completed PJM CEII Request Form and the appropriate PJM CEII NDA) that identifies each individual agent(s)/consultant(s) who may make individual requests for PJM CEII on behalf of such entity. The PJM CEII Authorization Form is located on the PJM website at: <https://www.pjm.com/library/request-access/form-ceii-consultant-request.aspx>

- Upon receiving all completed required CEII forms, PJM will determine if the requested information is CEII, and, if it is, whether to release the CEII to the requester. PJM will use the information provided by the requester in the PJM CEII Request Form to (1) establish whether a requester has presented a legitimate need for the CEII; and (2) weigh the need for the CEII against the potential harmful effects of its release. In reviewing the request from such individual, PJM will confirm the authenticity of the CEII requester and whether the request is consistent with the requestor's business or educational interest as determined from a review of publicly available data such as the requestor's website.

If PJM is unable to determine from publicly available information that the request is consistent with the requestor's business or educational interest in such data, the request will be denied. A requester shall provide additional information (beyond the PJM CEII Request Form) to PJM upon PJM's request.

1A.3.2 PJM CEII Handling

A recipient of PJM CEII shall maintain it in a secure place. Access to PJM CEII shall be limited to the recipient and other recipients of the identical CEII. Recipients may make copies of PJM CEII, but such copies are PJM CEII and subject to the same required handling. Recipient may make notes regarding the PJM CEII, but those notes shall be treated as PJM CEII notes if they contain CEII or were derived from PJM CEII.

Section 1: Process Overview

In this section you will find an overview of PJM's transmission planning process that culminates in the Regional Transmission Expansion Plan (RTEP). This process (referred to in this Manual interchangeably as the RTEP process or more generically as the PJM regional transmission planning process) is one of the primary functions of Regional Transmission Organizations (RTOs.) As such, PJM implements this function in accordance with the Regional Transmission Expansion Planning Protocol set forth in Schedule 6 of the PJM Operating Agreement.

As further described in following portions of this manual, the PJM RTEP process consists of baseline reliability reviews as well as analysis to identify the transmission needs associated with generation interconnection and merchant transmission interconnection. PJM implements the planning of interconnections as part of the broader RTEP process pursuant to the PJM Open Access Transmission Tariff (OATT.) The relationship between Interconnection planning and the RTEP is discussed in later sections of this manual and in related manuals.

1.1 Planning Process Work Flow

The Manual 14 series provides information regarding PJM's regional transmission expansion planning protocol (RTEPP) to complement planning provisions in the PJM Operating Agreement, Schedule 6 and the PJM Open Access Transmission Tariff (OATT), Attachment M-3 (Attachment M-3 Process). These documents can be found on-line at <https://www.pjm.com/library/governing-documents.aspx>.

This ongoing process has continued to evolve since 1997, when PJM's RTEPP (codified in PJM's Operating Agreement, Schedule 6) was approved by the Federal Energy Regulatory Commission (FERC). Since that time, the process has been expanded and enhanced in response to member and regulatory input as documented in the Operating Agreement, Schedule 6; OATT, Attachment M-3; and the PJM Manual 14 series. The current PJM regional transmission expansion plan (RTEP) process includes ample opportunity for stakeholder input through frequent oral and written exchange of information and reviews via the Transmission Expansion Advisory Committee (TEAC) and PJM's three (3) Subregional RTEP Committees (Mid-Atlantic, Southern and Western).

PJM and PJM Transmission Owners' near-term planning processes, looking at conditions out to year 5, are incorporated in an 18-month overlapping planning cycle which begins in September of the previous calendar year and extends through a full calendar year to the February of the next calendar year. The long-term planning processes, looking at conditions in years 6 through 15 and observing the same reliability criteria for the identification of required reinforcement, are incorporated in a 36-month planning cycle that begins in January of the first year and extends to December of the third year. These planning cycles are illustrated in Exhibit 1 in this Manual.

The PJM planning process activities, culminating in PJM's annual RTEP, constitute PJM's single, Order No. 890 compliant, transmission planning process.

All PJM OATT facilities are planned through and included in this open, fully participatory, and transparent process.

There are three (3) planning paths that ultimately culminate in the PJM RTEP base case, also referred to as the planning model. Facilities identified in each path allow **for** the opportunity for

early, full and transparent participation by interested PJM stakeholders. The three paths include planning activities associated with: (i) Regional RTEP Projects and Subregional RTEP Projects (baseline upgrades), (ii) Supplemental Projects; and (iii) Customer-Funded Upgrades. Baseline upgrades include projects planned for (i) reliability, including Form No. 715 criteria and operational performance, (ii) economic planning, and (iii) public policy planning (which may involve the use of the State Agreement Approach process).

Supplemental Projects refer to transmission expansion or enhancements not needed to comply with PJM reliability, operational performance, FERC Form No. 715, economic criteria or State Agreement Approach projects; Supplemental Project drivers, or needs, are “supplemental” to those Operating Agreement specified criteria. Transmission Owners plan Supplemental Projects in accordance with the OATT, Attachment M-3 Process. Projects planned through the Attachment M-3 Process include those that expand or enhance the transmission system. By way of example, a Supplemental Project could include a Transmission Owner project needed to address transmission facilities at the end of their useful life, which, in accordance with good utility practice, is not determined by the facility’s service life for accounting or depreciation purposes. Customer-Funded Upgrades refer to Network Upgrades, Distribution Upgrades or Merchant Network Upgrades identified pursuant to OATT Parts II, III and VIII and paid for by the Project Developer or Eligible Customer or voluntarily undertaken by an Upgrade Customer in fulfillment of an Upgrade Request.

Planning of Baseline Upgrades:

Baseline upgrades are produced from PJM’s planning cycle activities described in this manual, Operating Agreement Schedule 6, and illustrated in Exhibit 1 in this Manual. PJM leads the analysis and development of baseline upgrades related to reliability, operational performance, FERC Form No. 715 criteria and economic planning for all facilities 100 kV and above under PJM’s operational control. These facilities are designated as Bulk Electric System (BES) facilities and are subject to the North American Electric Reliability Corporation (NERC) standards and criteria for such facilities. The PJM analyses ensure compliance with NERC, PJM and any applicable Regional Entity criteria (e.g. Reliability First (RF) or SERC Reliability Corporation (SERC)). In addition, the PJM-led analyses also include analysis of and solutions for transmission facilities with nominal voltages below 100 kV to the extent such facilities are under PJM’s operational control (see <http://www.pjm.com/markets-and-operations/ops-analysis/transmission-facilities.aspx>). The TEAC and Subregional RTEP Committees provide the opportunity for stakeholders to engage in the PJM transmission planning process of such facilities, as described in this Manual.

In addition, for transmission facilities under PJM operational control, the Transmission Owner may submit its local planning criteria in its FERC Form No. 715 filing.

Transmission Owner Supplemental Projects:

Supplemental Projects refer to a transmission expansion or enhancement not needed to comply with PJM reliability, operational performance, FERC Form No. 715 or economic criteria. Transmission Owners plan Supplemental Projects in accordance with the Attachment M-3 Process. Projects planned through the Attachment M-3 Process could include those that: (i) expand or enhance the transmission system; (ii) address Transmission Owner zonal reliability issues; (iii) maintain the existing transmission system; (iv) comply with regulatory requirements or (v) implement Transmission Owner asset management activities (which could include needs

related to a transmission facility approaching the end of its useful life, which, in accordance with good utility practice, is not determined by the facility's service life for accounting or depreciation purposes).

Pursuant to the Attachment M-3 Process, Supplemental Projects are presented through the TEAC (230 kV and above facilities) or the Subregional RTEP Committees (below 230 kV facilities) for review and comment in a three-part meeting process that includes at a minimum (i) an Assumptions Meeting, (ii) a Needs Meeting and (iii) a Solutions Meeting. The Solutions Meetings are followed by a round of comments before the Transmission Owners finalize the Supplemental Projects. The stakeholders are provided a final comment period before the Supplemental Project is included in the Local Plan. Supplemental Projects included in the Local Plan are provided to the TEAC and the PJM Board as informational before integrating the Supplemental Project into the RTEP base case. Supplemental Projects are not approved by the PJM Board.

It should also be noted that prior to integrating a Supplemental Project into the RTEP base case PJM performs a "do no harm study" to evaluate whether a proposed Supplemental Project will adversely impact the reliability of the Transmission System as represented in the planning models used in all other PJM reliability planning studies. If as a result of the do no harm study, system upgrades are required, such upgrades will be considered part of the Supplemental Project and are the responsibility of the Transmission Owner sponsoring the Supplemental Project.

As part of the review of Supplemental Projects, PJM will inform stakeholders if PJM determines that a proposed Supplemental Project does not meet the Operating Agreement definition of a Supplemental Project. Additionally, PJM will monitor the status of the projects being developed through the Attachment M-3 Process in order to associate the Supplemental Project with the need identified by the Transmission Owner in the Attachment M-3 Process. For Supplemental Projects, the transparent identification of the need is important to PJM's regional planning process and, accordingly, the identification of the need should include a description of the need in sufficient detail that together with the applicable criteria and supporting documentation stakeholders are capable of reviewing the Transmission Owner's need determination as well as replicating the results of the planning studies.

A Project proposed as a Supplemental Project that does not meet the definition of Supplemental Project or cannot be associated with the need identified by the Transmission Owner in the Attachment M-3 Process will not be included in the Local Plan. Supplemental Projects, to the extent they are developed through the Attachment M-3 Process and can be associated with a supplemental need(s) identified by the relevant TO, will be included in the next annual RTEP base case.

Through the Attachment M-3 Process, Supplemental Projects are subject to similar open, transparent and participatory PJM committee activities, as are baseline upgrades developed through the TEAC and the Subregional RTEP Committee meetings (see discussion of TEAC and Subregional RTEP Committees).

As part of the review of Supplemental Projects PJM will also apprise the relevant Transmission Owner if a baseline upgrade might alleviate or partially mitigate the need for a Supplemental Project. In addition, PJM will determine if a Supplemental Project might impact a baseline need

identified through the RTEP process, which might be in progress. A discussion of guidelines associated with potential for overlapping needs is included in this Manual below in section 1.4.2.

Planning for Customer-Funded Upgrades is performed in response to a New Service Request or Upgrade Request, and includes Network Upgrades, distribution system upgrades or Merchant Network Upgrades identified pursuant to OATT Parts II, III and VIII. Studies of interconnection and transmission service requests and any resulting transmission modifications are posted to PJM's website in the project cycle

area (<http://www.pjm.com/planning/generation-interconnection.aspx>). In addition, any necessary transmission facility modifications are brought to the TEAC for presentation and stakeholder participation. Interconnection planning is discussed in more detail in Manual 14H.

1.2 TEAC and Subregional RTEP Committee and Related Activities

The PJM TEAC functions in accordance with its established charter and provisions of the Operating Agreement, Schedule 6. Additionally, in 2008 PJM began to facilitate more localized planning functions through the Subregional RTEP Committees.

The TEAC and Subregional RTEP Committees provide a transparent and participatory planning process throughout the development of the RTEP, from early assumptions-setting stages to discussion of criteria violations and/or identified system needs, review of recommendations for alternative solutions and then review and comment regarding the solutions incorporated into the RTEP base case.

The Subregional RTEP Committees allow more focused and meaningful stakeholder participation and attention to the subregional and local Transmission Owner zonal issues. Currently, there are three PJM RTEP subregions: Mid-Atlantic, Southern, and Western. When a Subregional RTEP Committee meeting is needed and scheduled, it generally will be implemented as a separate meeting for each subregion.

All PJM stakeholders can participate in any or all subregional activities on a voluntary basis, with one exception. The exception is that the Transmission Owners that comprise each of the various subregions must participate in the Subregional RTEP Committee meeting that includes their area and each Transmission Owner must be present at the TEAC meeting where its Supplemental Projects are presented. PJM will facilitate TEAC and Subregional RTEP Committees to review Regional RTEP Projects, Subregional RTEP Projects and Supplemental Projects.

PJM, with stakeholder input, may initiate additional Subregional RTEP Committees meetings consistent with the Attachment M-3 Process to review and address stakeholder questions or concerns regarding needs or proposed solutions, as may be necessary or beneficial. Separate local meetings or more localized reviews may also be held by individual PJM Transmission Owners in the event that the individual Transmission Owner decides that it is a more appropriate way to address local issues. In addition to their participation in the TEAC and Subregional RTEP Committees meetings, stakeholders can also provide written comments on the development of baseline upgrades and Supplemental Projects. Written comments can be provided to PJM through the Planning Community on PJM.com.

For administrative convenience, RTEP projects (i.e., baseline upgrades) are separated into

Regional RTEP Projects (230 kV and above) and Subregional RTEP Projects (below 230 kV) (referred to collectively herein as “RTEP Projects”), as defined in the Operating Agreement, in order to make an initial categorization and posting of violations and upgrades that will enable stakeholders to more easily sort through and review issues of interest.

Regional RTEP Projects and Supplemental Projects (230 kV and above) will be reviewed at the TEAC. Subregional RTEP Projects and Supplemental Projects (below 230 kV) will be reviewed at the applicable Subregional RTEP Committee. The Subregional RTEP Committee is responsible for the initial review of Subregional RTEP Projects. For Regional and Subregional RTEP Projects, the TEAC and Subregional RTEP Committees follow the procedure set forth in the Operating Agreement, Schedule 6 specific to the TEAC and other applicable PJM committee procedures. For Supplemental Projects subject to Attachment M-3, the Attachment M-3 Process will apply.

Review of RTEP Projects and Supplemental Projects at the TEAC and/or Subregional RTEP Committees normally occurs during the February through August RTEP stakeholder analysis and review periods (see Exhibit 1). However, additional Supplemental Projects for unforeseen needs that a PJM Transmission Owner identifies later in the year will follow OATT, Attachment M-3 Process for inclusion in the RTEP.

Stakeholders will be provided the information necessary for participation in the discussions and evaluations, including: (1) the PJM and/or Transmission Owners models, criteria and assumptions that underlie transmission system plans, (2) the procedure to access the study information necessary to replicate the PJM and/or Transmission Owner planning studies and participate in the evaluation and discussion of the identified need, (3) information regarding the project proposed to address the identified need, (4) the current cost estimate for the project, and (5) a description of the proposed modifications to existing facilities that may be part of the project.

In addition, projects that originate through Transmission Owner planning will be posted on the PJM web site. This site will include all currently planned baseline upgrades and newly planned Supplemental Projects and Transmission Owner Initiated projects from past RTEP cycles that are yet to be placed in-service). This website provides tracking information about the status of listed projects and planned in-service dates. It also includes information regarding criteria, assumptions and availability of study cases.

1.3 Planning Assumptions and Model Development

1.3.1 Reliability Planning (including Operational Performance, Form No. 715 and Public Policy Planning)

PJM’s planning analyses are based on a consistent set of fundamental assumptions regarding load, generation and transmission built into power flow models. Load assumptions are based on the annual PJM entity load forecast independently developed by PJM (found at <http://www.pjm.com/planning/resource-adequacy-planning/load-forecast-dev-process.aspx>). This forecast includes the basis for all load level assumptions for planning analyses throughout the 15 year planning horizon. Transmission planning assumptions are embodied in the base case power flow models developed annually by PJM and derived from the Eastern Reliability Assessment Group processes and procedures pursuant to NERC standard

MOD-032, as well as Transmission Owners' assumptions included in their respective FERC Form No. 715.

A single reliability planning process 36-month cycle is comprised of three overlapping 18-month near-term planning cycles to identify and develop shorter lead-time transmission enhancements or expansions and one 36-month long-term planning cycle to provide sufficient time for the identification and development of longer lead-time transmission enhancements or expansions that may be required to satisfy planning criteria. While these processes are separate, they do not operate exclusively of each other and consideration must be given to the findings and actions taken in both when assumptions are considered, and analyses is completed. Consistent with the requirements of the NERC TPL Reliability Standards, the reliability planning process includes both near-term (years one through five) and long-term (years six through fifteen) assessments of the transmission system as described further in section two of this Manual 14B.

RTEP assumptions are vetted with the Independent State Agencies Committee (ISAC), stakeholders at Transmission Expansion Advisory Committee (TEAC) and Subregional RTEP Committees. Final determination of all assumptions to be included in any scenario or sensitivity study will be made by PJM and shared with stakeholders at the TEAC.

Assumptions related to system load for the near-term planning process will be based on the [PJM](#) load forecast as discussed above. Load assumptions for the long-term planning process will start with the load forecast as discussed for the near-term process, but may also include additional assumptions regarding increased and new types of electrification. These assumptions will be discussed with the ISAC, TEAC and SRTEP committees during the beginning of each of the respective processes.

Generation assumptions include those necessary to account for both addition, and removal of generation resources. Generation assumptions included in the near-term models primarily consist of existing generation, announced retirements and addition of generation with an appropriate interconnection agreement or Wholesale Market Participant Agreement (WMPA), as well as any generation that meets Decision Point II requirements of the interconnection process, if needed to meet load. Near-term models may include generation deactivations for generation impacted by federal and state public policy considerations and publicly available company commitments to retire generation that are brought to the attention of PJM. Generation assumptions in the long-term models include; 1) additions included in the near-term models but may also include generation additions beyond those in the New Service Request process, and 2) generation removal which, based on analysis of economics and federal and state public policy impacts over the planning horizon, could be significantly at risk for deactivation. Generation additions in the long-term models will be constructed using widely accepted capacity expansion modeling tools that leverage information from the New Service Request process and other sources of information on the economic potential of different assets at different locations to characterize possible future grid outcomes. An example of these tools is capacity expansion models that identify the economic resource fleet with consideration of, among other things, the projected load, resource adequacy constructs, future technology costs and characteristics, fuel prices and renewables' potentials at different locations, transmission headroom, and federal and state policies. The capacity expansion modeling tools will be reviewed with stakeholders beginning in the assumptions phase of LTRTP development and refined periodically as necessary to improve the models' performance. Long-term models will

include generation deactivation for generation impacted by federal and state public policy considerations. The deactivation of generation impacted by economic considerations will also be considered, for example through sensitivity studies. Inclusion of these deactivations is necessary to reduce the possibility for the need of solutions that might otherwise be required in as little as 90 days; in accordance with procedures for the deactivation of generation outlined in Part V of the Tariff. Collectively, the generation changes made to the near-term models to construct the long-term scenario and sensitivity planning models constitutes the long-term capacity expansion. PJM will construct one base reliability scenario, described in Attachment C, section 4.1, and one scenario to support public policy planning described in section 2.1.4, and consider the need for additional sensitivities and scenarios to inform the reliability planning and public policy planning processes consistent with Operating Agreement, Schedule 6, section 1.5.3. A scenario is a model representation of power system outcomes given a full set of assumptions; a sensitivity is defined relative to a scenario by changing generally one assumption at a time to understand its impact on analyses' results. During the beginning of the 36-month long-term planning cycle, for a time which may include up to the first twelve months of the cycle, PJM will work closely with the Independent State Agencies Committee (ISAC) and the TEAC to develop the assumptions and methods to be used in the capacity expansion and will provide opportunity for meaningful stakeholder review and comment, including when changes are made to these basic assumptions and methods.

As necessary, PJM updates its models (e.g., power flow, short circuit, and stability) with the most recent data available for its own regional studies. All PJM base power flow and related information are available pursuant to applicable Critical Energy Infrastructure Information, Non-Disclosure and OATT-related requirements (accessible via <http://www.pjm.com/planning/rtep-development/powerflow-cases.aspx> or by contacting the PJM Planning Committee contacts listed on the committee page on PJM.com). Each type of RTEP analysis (e.g., load deliverability, generator deliverability etc.) encompasses its own methodological assumptions as further described throughout the rest of this Manual. Additional details regarding the reliability planning criteria, assumptions, and methods can be found in the following sections and this manual's Attachments.

Attachment J contains the checklist for the new equipment energization process to be utilized by Transmission Owners and Designated Entities from inception to energization of upgrade projects.

1.3.2 Economic Planning

Each year as part of the 24-Month Market Efficiency Cycle, PJM performs a market efficiency analysis, following the completion of the near-term reliability plan for the region. PJM's market efficiency planning analyses will utilize many of the same starting assumptions applicable to the reliability planning phase of the RTEP development. In addition, key market efficiency input assumptions, used in the projection of future market inefficiencies; include load and energy forecasts for each PJM zone, fuel costs and emissions costs, expected levels of potential new generation and generation retirements and expected levels of demand response. PJM will input its study assumptions into a commercially available market simulation data model that is available to all stakeholders. The data model contains a detailed representation of the Eastern Interconnection power system generation, transmission and load. In addition, the market efficiency analysis of the cost/benefit of potential market efficiency upgrades will also include

the discount rate and annual revenue requirement rate. The discount rate is used to determine the present value of the enhancements' annual benefits and annual cost. The annual revenue requirement rate is used to determine the enhancements' annual cost. PJM will finalize the market efficiency analysis input assumptions soon after the development of the PJM load forecast that is generally available approximately in late January. Prior to finalizing, PJM will review the proposed assumptions at the PJM Transmission Expansion Advisory Committee. This review will provide the opportunity for stakeholder review of and input to all of the key assumptions that form the basis of the market efficiency analysis. In this way, PJM will facilitate a comprehensive stakeholder review and input regarding RTEP study assumptions. All final assumptions and analysis parameters will be presented to the TEAC for discussion and review and to the PJM Board for consideration.

1.3.3 FERC Form No. 715

The Transmission Owner's process specific to the Transmission Owner's zone, including projects that could address the end of useful life of existing facilities, which, in accordance with good utility practice, is not determined by the facility's service life for accounting or depreciation purposes, may be memorialized as Transmission Owner planning criteria under the Transmission Owner's FERC Form No. 715.

1.3.4 Supplemental Projects

Supplemental Projects are included in both PJM and Transmission Owners planning models for the applicable reliability studies conducted outside the Attachment M-3 Process, to the extent the Supplemental Project impacts the transmission system.

The Transmission Owners' planning of Supplemental Projects follows the sequence of steps set out in the Attachment M-3 Process. Commencing September of the year preceding the next RTEP year, PJM will include as part of the model development for the next year's RTEP base case (see 18-month planning cycle illustrated in Exhibit 1 in this Manual), those Supplemental Projects submitted by the Transmission Owners for inclusion in the Local Plans in the July timeframe.

Additional Supplemental Projects for unforeseen needs that a PJM Transmission Owner identifies later in the year, and which are finalized after July, may be included in the base case if the inclusion of these projects would not disrupt analysis associated with the development of the RTEP violations. Such additional Supplemental Projects must comply with the Attachment M-3 Process. Once PJM issues its preliminary RTEP models for verification of topology and dispatch prior to initiation of any preliminary RTEP analysis and quality control check in preparation for opening a proposal window, PJM will not consider for inclusion in the RTEP base case a subsequently-submitted proposed Supplemental Project(s) that would alleviate a violation identified in the proposal window. However, a Transmission Owner, or any other pre-qualified Designated Entity, may submit a project proposal for consideration in the proposal window to address a posted violation that would also address a related need identified in the Attachment M-3 Process.

1.4 RTEP Process Key Components

PJM's goal is to ensure electric supply adequacy and to enhance the robustness of energy and capacity markets. Achieving these objectives requires the successful completion of PJM's planning, facility construction and operational and market infrastructure requirements.

1.4.1 Key Process Drivers

Key components of PJM's 15-year transmission planning process discussed in this Manual include:

1.4.1.1 Baseline reliability analyses

The PJM Transmission System ("PJM System") provides the means for delivering the output of interconnected generators to the load centers in the PJM energy and capacity markets. Baseline reliability analyses ensure the security and adequacy of the Transmission System to serve all existing and projected long term firm transmission use including existing and projected native load growth as well as long term firm transmission service. RTEP baseline analyses include system voltage and thermal analysis, and stability, load deliverability, and generator deliverability testing. These tests variously entail single and multiple contingency testing for violations of established NERC reliability criteria regarding stability, thermal line loadings and voltage limits. Baseline reliability analyses are discussed in more detail in Section 2 and Attachment C.

1.4.1.2 Economic analyses (Market Efficiency studies)

In addition to reliability based analyses PJM also evaluates the economic merit of proposed transmission enhancements. These analyses focus on the economic impacts of security constraints on production cost, congestion charges to load and other econometric measures of market impacts. PJM's market efficiency analyses are discussed in Section 2 of this Manual and Attachment E. PJM development of economic transmission enhancements is also codified under Schedule 6 of the PJM Operating Agreement.

1.4.1.3 Operational performance issue reviews and accompanying analyses

Maintaining a safe and reliable Transmission System also requires keeping the transmission system equipment in safe, reliable operating condition as well as addressing actual operational needs. On an ongoing basis, PJM operating and planning personnel assess the PJM transmission development needs based on recent actual operations. This may lead to special studies or programs to address actual system conditions that may not be evident through projections and system modeling.

To ensure that system facilities are maintained and operated to acceptable reliability performance levels, PJM has implemented an Aging Infrastructure Initiative to evaluate appropriate spare transformer levels and optimum equipment replacement or upgrade requirements. This initiative, based on a Probability Risk Assessment (PRA) process, is intended to result in a proactive, PJM-wide approach to assess the risk of facility failures and to mitigate operational and market impacts. Section 2 of this manual provides further discussion of the PRA process.

1.4.1.4 FERC Form No. 715

Each Transmission Owner specifies reliability criteria it uses to evaluate system performance in its FERC Form No. 715 filing. As part of the RTEP process, PJM will identify system needs using each Transmission Owner's planning criteria, which could include end of useful life, which, in accordance with good utility practice, is not determined by the facility's service life for accounting or depreciation purposes and other asset management activities, reflected in the Transmission Owner's FERC Form No. 715.

1.4.1.5 Supplemental Project Planning

Transmission Owner may identify a need associated with a transmission expansion or enhancement not required to comply with the PJM reliability, operational performance, FERC Form No. 715 or economic criteria. The PJM Transmission Owners plan Supplemental Projects in accordance with the Attachment M-3 Process. Projects planned through the Attachment M-3 Process could include those that: (i) expand or enhance the transmission system; (ii) address local reliability issues; (iii) maintain the existing transmission system; (iv) comply with regulatory requirements; or (v) implement Transmission Owner asset management activities (which could include needs related to a transmission facility approaching the end of its useful life, which, in accordance with good utility practice, is not determined by the facility's service life for accounting or depreciation purposes).

1.4.1.6 Customer-Funded Upgrade analyses

A Customer-Funded Upgrade is a Network Upgrade, Distribution Upgrade or Merchant Network Upgrade (Network Upgrade) the cost of which is paid for by a Project Developer, Eligible Customer or Upgrade Customer. All entities requesting interconnection of a generating facility (including increases to the capacity of an existing generating unit) or requesting interconnection of a merchant transmission facility within the PJM region must do so through PJM's interconnection process detailed in OATT, Parts IV and VIII. PJM studies the interconnection and deliverability of New Service Requests or Upgrade Requests in the local area at the Point of Interconnection to determine whether Customer-Funded Upgrades are required to either interconnect to the system or upgrade existing transmission facilities. The interconnection process and deliverability testing procedures are discussed further in this Manual in Attachment C and Manual 14H. The evaluation of generation and merchant transmission New Service Requests is codified in the Tariff, Parts IV and VIII

1.4.1.7 The Final RTEP Plan

Based on all of the requirements for firm transmission service on the PJM System, PJM develops an annual RTEP to meet those requirements on a reliable, economic system development and environmentally acceptable basis.

Furthermore, by virtue of its regional scope, the RTEP process assures coordination of expansion plans across multiple transmission owners' systems, permitting the identification of the most efficient or cost-effective expansion plan for the region. The RTEP developed through this process is reviewed and approved by PJM's Board of Managers. The Supplemental Projects are integrated into the RTEP, however the Board does not approve individual Supplemental Projects. The following Section 2 describes the PJM RTEP Process analysis.

1.4.1.8 Maintaining reliability associated with critical substations

To ensure the reliability of the transmission grid into the future, PJM has implemented a set of analysis to further enhance system reliability as discussed in Section 2.9 of this Manual 14B. This study is based on technical analysis performed, such as that performed using the PJM cascading trees tool software, and incorporates standard analytical methods of power flow study. As part of the RTEP process, PJM will analyze all transmission system enhancements to ensure that acceptable critical substation planning analysis objectives are maintained based on the analysis.

1.4.2 Coordination of Baseline Upgrades, Supplemental Projects and Customer-Funded Upgrades

Changes to the transmission system are incorporated into the RTEP base case based on the process drivers outlined in section 1.4.1 above in the form of three different types of upgrades or projects: 1) baseline upgrades (see sections 1.4.1.1 – 1.4.1.4); 2) Supplemental Projects (see sections 1.4.1.5); and 3) Customer-Funded Upgrades (see sections 1.4.1.6).

During the course of reviewing any upgrade or project, PJM will work with stakeholders to identify any upgrades or projects, or portions thereof that interact electrically. By doing so, PJM is able to determine the proper classification of a project based on one or more types of drivers, as well as develop the more efficient or cost-effective solutions.

1.4.2.1 When a Need is identified in the Attachment M-3 Process that requires development of a Supplemental Project (not yet included in RTEP base case)

During a review of the RTEP analysis, it may become apparent that a supplemental need identified in the Attachment M-3 Process may interact with an identified violation, system condition, economic constraint, or public policy requirement posted on the PJM website. In this case, PJM will provide notice of the potential interaction associated with the posted system condition by posting the newly available information to the PJM website and provide notification to stakeholders. In addition, PJM may determine whether to lengthen an open proposal window in order to permit project proposers additional time to consider the availability of new or changed information. PJM can consider proposals, including proposals in its open proposal window that more efficiently and cost-effectively address both the identified baseline need(s) and any related needs identified in the Attachment M-3 Process.

1.4.2.2 When a Supplemental Project is submitted for inclusion in the Local Plan (not yet included in RTEP case)

During a review of the RTEP analysis, including input from stakeholders, it may become apparent that a Supplemental Project submitted for inclusion in the Local Plan, but not yet included in the RTEP base case, may interact with an identified violation, system condition, economic constraint, or public policy requirement posted on the PJM website. In this case, PJM will provide notice of the potential interaction associated with the posted system condition included in the PJM open proposal window. In addition, PJM may determine whether to lengthen the open proposal window in order to permit project proposers additional time to consider the availability of new or changed information regarding the facilities associated with the open proposal window, including any related needs identified in the Attachment M-3 Process.

In the development of the RTEP, PJM shall examine whether a possible baseline upgrade would more efficiently and cost-effectively address the identified regional need, as well as a supplemental need addressed by a proposed Supplemental Project.

If PJM identifies that a possible baseline upgrade would more efficiently and cost-effectively address the identified regional need, as well as a supplemental need, PJM will discuss with the relevant Transmission Owner and other stakeholders at the next appropriate Subregional RTEP or TEAC meeting. PJM shall submit the proposed baseline upgrade to the PJM Board for inclusion in the RTEP.

The Transmission Owner shall determine whether the baseline upgrade meets the supplemental need addressed by the proposed Supplemental Project and, if so, the Transmission Owner will withdraw the project from inclusion in the Local Plan. The Transmission Owner will inform PJM and the stakeholders at the next appropriate Subregional RTEP or TEAC meeting that the Supplemental Project will not be submitted for inclusion in the Local Plan.

If the Transmission Owner subsequently determines that the supplemental need is not met, the TO at the next appropriate Subregional RTEP or TEAC meeting will: (1) provide documentation to PJM and the stakeholders on the rationale supporting its determination; and, (2) inform PJM and the stakeholders that the Supplemental Project will be submitted for inclusion in the Local Plan. Accordingly, PJM will include the proposed Supplemental Project in the next RTEP base case. After discussion with the relevant Transmission Owner, PJM will notify the relevant regulatory siting authority, if applicable, when a Supplemental Project is being reviewed that PJM has identified a baseline violation for which the baseline solution may impact the supplemental need for the Supplemental Project.

Any disputes arising under Attachment M-3, including any substantive and procedural disputes arising from the transmission planning process, may be resolved in accordance with the dispute resolution procedures in Schedule 5 of the Operating Agreement.

1.4.2.3 When a baseline upgrade is included in RTEP base case (in a prior RTEP cycle) and a Supplemental Project or Customer-Funded Upgrade is identified which interacts with the need for the baseline upgrade

PJM will review the needs for each of the upgrades or projects and review these needs with the stakeholders. This review will include, but is not limited to, the determination of how each upgrade or project may or may not satisfy the needs of one or more of the processes, and a review of the proposed schedules for the upgrades or projects and the system timing needs in order to inform these discussions.

Following a review of the applicable information, PJM shall determine the steps to be taken in order to preserve baseline reliability while also accommodating other system needs for the M-3 and the Cycle and Upgrade Request evaluation processes. Stakeholders will be provided an opportunity to discuss PJM's findings prior to PJM making a decision as to how PJM will proceed.

The Transmission Owners provide status updates in accordance with Section 6 of Manual 14C. Such status updates should include an indication of any relevant regulatory siting authority approval necessary for the project and the status of such approval. If at any time, PJM identifies a baseline need where a possible baseline upgrade would more efficiently and cost-effectively

address the baseline need, as well as the identified needs for any proposed Supplemental Project, PJM will notify the relevant regulatory siting authority where the Supplemental Project is being reviewed that PJM has identified a baseline violation for which the baseline upgrade may impact the supplemental need for the Supplemental Project.

1.4.2.4 Incorporation of EOL Needs into the RTEP

The Transmission Owners shall prepare and provide to PJM, on an annual basis, a Candidate EOL Needs List. This The candidate EOL list shall be comprised of a Transmission Owners its non-public confidential, non-binding projection of up to 5 years of EOL Needs that it has identified under the Transmission Owner's processes for identification of EOL Needs. The methodology used by the Transmission Owner to determine inclusion in this EOL list shall be presented to stakeholders annually, and will generally be provided during the assumptions meeting as part of the M-3 process as outlined in Section 1.1. PJM shall identify any potential substantial electrical overlap between an identified PJM planning criteria need identified during the current PJM planning cycle, under the RTEP process and a projected EOL need facility on a Transmission Owner's Candidate EOL Needs List that could potentially be addressed by a single solution., PJM will consult with the relevant Transmission Owner to confirm the projected EOL need still exists. If Transmission Owner confirms the projected EOL need still exists, PJM would post both the PJM planning criteria need and projected EOL need facility as required pursuant to Schedule 6 open window process, noting the overlap on the list of violations posted for the proposal window.

1.4.3 Addition and Removal of System Projects or Upgrades from the RTEP Base Cases

The development of an RTEP requires PJM to maintain a base case that includes all previously identified system reinforcements regardless of the driver to be used in its analysis of system needs.

Each year, PJM must lock down the assumptions included in the annual RTEP base case in order to move forward with its analysis. PJM will employ the following guidelines regarding when to include the following types of projects or upgrades in the annual RTEP base case:

1. Baseline upgrades will be included in the next RTEP base case once the baseline upgrade is approved by the PJM Board in accordance with Schedule 6 of the Operating Agreement
2. Customer-Funded Upgrades will be included in the next RTEP base case once: (1) the Customer-Funded Upgrades are included in an executed Generator Interconnection Agreement, Upgrade Construction Service Agreement, Wholesale Market Participation Agreement or Transmission Services Agreement; or, (2) if the completion of the RTEP requires inclusion of New Service Requests that have met all Decision Point II requirements in order to meet the new load requirements resulting from normal forecasted load growth.
3. Supplemental Projects will be included in the next RTEP base case following inclusion of the Supplemental Project in the Local Plan, consistent with section 1.4.2.2 above.

4. A Customer-Funded Upgrade may be removed from the RTEP base case upon termination or cancellation of an executed service agreement provided such upgrade is not required by another New Service Request in the same Cycle.
5. If a relevant regulatory siting authority denies a siting application for a project included in the RTEP or refuses to allow the project to move forward under the conditions specified in such order and such order is a final regulatory order exhausting all regulatory process, the following guidance is provided:
 - a. The entity receiving a final regulatory order from the relevant regulatory siting authority shall promptly notify and provide PJM with a copy of such order; i Upon receipt of such notice, PJM will review the impacts associated with removing the project from the RTEP or continuing to include such project in light of such final regulatory order (see section 1.4.2 above for guidance relative to the review process);
 - b. PJM shall present to the TEAC the results of PJM's re-evaluation for review and comment.
 - c. A project denied siting authority in a final regulatory order by the relevant regulatory siting authority will generally be removed from the RTEP base case as determined by PJM after discussion with the relevant Transmission Owner(s) or Designated Entity and vetting with stakeholders at the TEAC. A project will generally not remain in the RTEP base case during the duration of a court appellate action. Decisions to remove a baseline upgrade from the RTEP base case will be submitted to the PJM Board and decisions to remove a Supplemental Project from the RTEP base case will be provided to the applicable Transmission Owner. In those circumstances in which PJM determines the need to deviate from this guidance, PJM will discuss such decisions with the TEAC.

1.5 Planning Criteria

1.5.1 Reliability Planning

PJM and/or Transmission Owners' planning information, including models, criteria and assumptions, provided pursuant to Operating Agreement, Schedule 6 or OATT, Attachment M-3 must be adequate to allow stakeholders to replicate the results of planning studies.

Stakeholders have the opportunity at a national level through the participatory standards development process of the North American Electric Reliability Corporation (NERC) to influence the industry planning criteria that form the basis of PJM's planning process (found at <http://www.nerc.com/Pages/default.aspx>.) NERC regional criteria development, applicable to PJM, is also open to stakeholder input through the open and participatory process of ReliabilityFirst Corporation (found at <https://rfirst.org/ProgramAreas/Standards/>.)

Additionally, regional and Transmission Owner planning criteria that go beyond and complement the NERC Reliability Standards can be created and incorporated into PJM planning through participation in PJM's Planning Committee and other related stakeholder processes (please refer to <http://pjm.com/committees-and-groups/committees.aspx>.) In this manner, PJM, as the independent planning authority, avails stakeholders full opportunity to participate in the planning

process from assumptions setting to the final plan. The PJM regional plan is based on the effective criteria in place at the time of the analyses, including applicable standards and criteria of the NERC and the applicable regional reliability entity¹, the various Nuclear Plant Licensees' Final Safety Analysis Report grid requirements and the PJM and Transmission Owner Reliability Planning Criteria (Attachment D). Section 2 details the specific criteria applicable to each transmission planning process study phase. Criteria are comparably applicable to all similarly situated Native Load Customers and other Transmission Customers.

1.5.2 Market Efficiency Planning

Market efficiency planning is an evaluation process that results in facilities planned to achieve economic efficiencies rather than an analysis that produces violations measured against criteria. This process compares alternative plans' cost effectiveness in improving transmission efficiency and produces RTEP recommendations from this process. The metrics of economic inefficiency include historic and projected congestion. The measures of historic congestion are gross congestion, unhedgeable congestion, and pro-ration of auction revenue rights. The measure of projected congestion is based on a market analysis of future system conditions performed with a commercially available security constrained, economic dispatch market analysis tool. This market analysis results in future projections of the congestion and its binding constraint drivers. These congestion measures are posted and available to stakeholders by binding constraint and form the basis for PJM and stakeholder development of remedies. Transmission plans from the reliability analysis or a new plan presented that economically relieves historical or projected congestion are candidates for market efficiency solutions. The successful candidates will be those facilities that pass PJM's threshold test and bright line economic efficiency test. This test specifies that a proposed solution's savings must exceed its projected revenue requirements, on a 15 year present worth basis, by at least 25% (the threshold cost/benefit test). Each of this process' elements, its underlying assumptions and its methods is described in more detail in the accompanying sections of this manual 14B and in Attachment E.

1.5.3 FERC Form No. 715 Planning

The Transmission Owner's local planning criteria may be included in its FERC Form No. 715 filing. These documents may include criteria governing the planning of upgrades to the transmission system, which is in addition to the PJM Planning criteria and may include information specific to a Transmission Owner's asset management activities.

1.5.4 Supplemental Project Planning

The criteria driving the need for Supplemental Projects (which could include criteria required to address end of useful life of existing transmission facilities, and which, in accordance with good utility practice, is not determined by the facility's service life for accounting or depreciation purposes) are provided by each Transmission Owner consistent with the OATT Attachment M-3 process.

1 The ReliabilityFirst Regional Reliability Corporation (RRC) for the PJM Mid-Atlantic and Western Regions (which replaced the former ECAR, MAAC and MAIN RRCs on January 1, 2006) and the Virginia-Carolinas (VACAR) Area Reliability subregion of the SERC Reliability Corporation for PJM Southern Region.

Section 2: Regional Transmission Expansion Plan Process

In this section you will find an overview of the PJM Region transmission planning process covering the following areas:

- Components of PJM's 15-Year planning
- The need and drivers for a regional transmission expansion plan
- Reliability planning overview
- Specific components of reliability planning and the Stakeholder process
- Interconnection request drivers of RTEP
- Cost responsibility for reliability related upgrades
- Market efficiency planning review
- Specific components of market efficiency planning and the Stakeholder process.
- Operational performance driven planning
- Specific components of operational performance driven planning

2.1 Transmission Planning = Reliability Planning + Market Efficiency + FERC Form No. 715 + Public Policy + Supplemental Project Planning

Effective with the 2006 RTEP, PJM, after stakeholder review and input, expanded its RTEP Process to extend the horizon for consideration of expansion or enhancement projects to fifteen years. This enables planning to anticipate longer lead-time transmission needs on a timely basis.

Fundamentally, the baseline reliability analysis underlies all planning analyses and recommendations. On this foundation, PJM's 15-year planning review now yields a regional plan that encompasses the following:

1. Baseline reliability upgrades, discussed in this Section 2;
2. Operational Performance issue driven upgrades, discussed in Section 2;
3. Market efficiency driven upgrades, discussed in this Section 2;
4. FERC Form No. 715 projects, discussed in Section 2;
5. State public policy projects, [discussed in Section 2. as defined in the Operating Agreement, Schedule 6, section 1.5.9;](#)
6. Supplemental Projects by a Transmission Owner, addressed via OATT, Attachment M-3, which could include projects addressing the end of useful life of existing facilities, which, as determined in accordance with good utility practice, is not determined by the facility's service life for accounting or depreciation purposes.
7. Avoidance of system enhancements that do not meet critical substation planning analysis objectives discussed in Section 2.

2.1.1 Multi-Driver Approach

In the event that a proposed project is driven by more than one of the above stated drivers, PJM can develop a Multi-Driver Approach Project, as defined in Schedule 6 of PJM's Operating Agreement by identifying a more efficient or cost effective solution that follows one of the following methods:

Proportional Multi-Driver Method: Combining separate solutions that address reliability, economics and/or public policy into a single transmission enhancement or expansion that incorporates separate drivers into one Multi-Driver Project.

Incremental Multi-Driver Method: Expanding or enhancing a proposed single-driver solution to include one or more additional component(s) to address a combination of reliability, economic and/or public policy drivers.

2.1.1.1 Principles and Guidelines for New Service Requests as an input to Multi-Driver Approach

Customer-Funded upgrades, as identified in PJM Manual 14H may be incorporated into the Multi-Driver Approach Project per the Regional Transmission Expansion Plan. Project Developers, other than those proposing Merchant Network Upgrades, have the option, but not obligation to participate in a Multi-Driver Approach Project, at the direction of PJM. The following principles and guidelines must be adhered to for a Project Developer wishing to participate in a Multi-Driver Approach Project:

1. The Multi-Driver Approach Project must be more cost effective as a whole, than the sum of the individual projects
2. Project Developer has the option, but not the obligation to participate in a Multi-Driver Approach Project. The Project Developer must execute an agreement committing to be financially responsible for its portion of the Multi-Driver Approach Project, the cost of which shall not exceed the cost of the incremental upgrade required as part of the New Service Request, unless agreed to by the sponsoring Project Developer(s).
3. Project Developer's participation in the Multi-Driver Approach Project shall not impact the Project Developer's Cycle position.
4. Commencement of service for the Project Developer's Customer Facilities may be impacted by the in-service date of the Multi-Driver Approach Project.
5. The following cost allocation rules will apply to Multi-Driver Approach Projects: Schedule 12 of the PJM Tariff for the component of the upgrade to be funded for reliability violations or operational performance, economic constraints and/or Public Policy Requirements; and Part VIII of the PJM Tariff for the Project Developer's portion of the Multi-Driver Approach Project.

2.1.2 Reliability Planning

Exhibit 1 shows the 15-year reliability planning process which is comprised of 18-month near-term and 36-month long-term cycles to cover the RTEP 15-year planning horizon. The reliability planning process integrates information transparency, stakeholder input and review, and PJM Board of Manager approval into the selection of transmission enhancements or expansions. Activities shown on this diagram and their timing are for illustrative purposes. The

actual timeline may vary to some degree to be responsive to the RTEP and stakeholder needs.

The first step in the process is to develop the set of assumptions that will be used for the subsequent power flow models, scenarios and analyses. These assumptions are developed and vetted with the Independent State Agencies Committee (ISAC) and stakeholders at Transmission Expansion Advisory Committee (TEAC) and Subregional RTEP Committees meetings.

A series of power flow base cases are then developed based on the assumptions. The yearly series of cases include the latest information and assumptions available related to load, resources and transmission topology. Five-year-out base cases are developed for near-term baseline reliability analysis. Base cases for analyses of years closer than 5 years are developed as required. Retool analysis is used to review previously established assumptions, later in the planning cycle, as those assumptions may have changed.

In addition to these near-term base cases, additional power flow base cases are developed for long-term planning. These long-term cases are used to evaluate the need for more significant projects requiring a longer lead time to develop them. These longer lead time projects generally provide a more regional benefit, for example in the form of production cost savings, capital investment savings, reduced loss of load, and considerations in Manual 14f, Attachment C. The long-term base cases developed at the start of each 36-month planning cycle are based on the system conditions that are expected to exist in years eight and 15. As noted in Exhibit 1, the 8-year out base cases are updated and retooled at the start of each 18-month planning cycle with additional criteria analysis being run to validate the findings from the prior year's year 8 analysis and also to identify any new transmission enhancements or expansions that may need to be addressed with the updated assumptions.

The long-term planning process may have one or more scenarios and/or sensitivities in addition to a single base reliability scenario that PJM believes is necessary to inform system reliability needs identified in the base reliability scenario. The base reliability scenario is described in more detail in Attachment C, section 4.1. As a result, the first phase of the long-term planning cycle is devoted to working closely with the ISAC and TEAC to define the parameters that will be used in the development of these long-term planning assumptions to be used in the base case and in any scenario and sensitivity models.

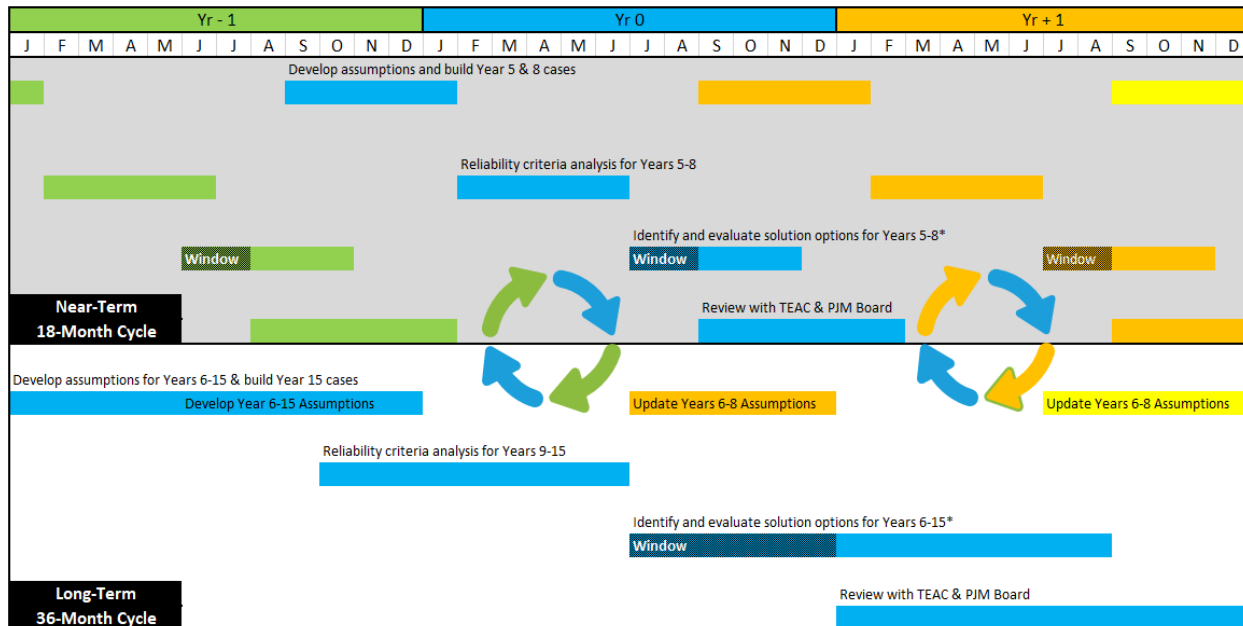

*Seek Transmission Solutions for less complex needs in the near-term 18-month cycle window, and address more complex system needs in the long-term 36-month long window.

Exhibit 1: Reliability Planning Cycle

The scope of the near-term baseline analysis that is completed as part of each 18-month planning cycle includes an exhaustive review of applicable reliability planning criteria on all BES facilities as described in section 2.3 of this manual. As noted above, PJM typically performs this near-term analysis on a 5-year out base case. Retool analyses of previous near-term assessments are also completed, as required. Any identified criteria violations are reviewed with stakeholders throughout the planning process. Ultimately, solutions to address the criteria violations are developed, reviewed with the TEAC and/or Subregional RTEP Committee, as applicable, and submitted to the PJM Board of Managers for approval. Through this planning process, a baseline system - without any criteria violations is developed for the near term (i.e., 5 year baseline).

Long-term planning is also completed as part of the development of the RTEP to identify solutions to planning criteria violations that require longer lead times to implement. As part of the 36-month planning cycle, PJM initially develops a set of year--8 and year-15 base cases that are used to evaluate planning criteria for the long-term planning horizon. Long-term criteria analysis is completed on these base cases during the second year of the 36-month cycle. During the latter part of the second and third years of the 36-month cycle, the year 8 models are updated and then studied in the subsequent year. A combination of a full AC power flow solution and linear analysis of the year-8 and year-15 base cases, as described in this manual, is used to determine the loading on facilities for years 6 through 15.

As shown in Exhibit 1 , during the latter portion of the second and third years of the 36-month planning cycle, the base case developed for the year-8 long-term analysis during the first year is

updated to reflect the latest assumptions about load, generation, demand response, energy efficiency, and transmission topology. Long-term criteria analysis is then completed on these updated year-8 base cases during the subsequent year.

Potential violations identified during the second year of the year-8 analysis are considered for system reinforcement and possible inclusion in the long-term competitive transmission solicitation window. Solutions to less complex needs may be sought in the near-term competitive transmission solicitation window. An independent consultant may be used to develop an independent cost estimate and evaluate the constructability of proposed solutions from these windows. Results from these long-term analyses, including potential violations and their solutions, are reviewed with the TEAC throughout the 36-month planning process.

Ultimately, any required Short-term Projects or Long-lead Projects that are identified and selected through the reliability planning process are presented to the PJM Board of Managers for approval. Once approved, PJM will periodically review the continued need for Long-lead Projects based on the most recent planning assumptions.

2.1.3 Market Efficiency Planning

Exhibit 3 shows the 24-month Market Efficiency process used for the 15-year RTEP horizon. Activities shown on this diagram and their timing are for illustrative purposes. The actual timeline may vary to some degree to be responsive to the RTEP and stakeholder needs.

The 24-month Market Efficiency process is made up of two similar 12-month cycles to identify approved RTEP projects that may be accelerated or modified and one 24-month planning cycle to provide sufficient time for the identification and development of longer lead-time transmission upgrades.

The first step in the Market Efficiency process is to develop the set of assumptions that will be used for the subsequent analyses. These assumptions are vetted with stakeholders at the Transmission Expansion Advisory Committee meetings.

The scope of the near-term Market Efficiency analysis that is completed as part of each 12-month planning cycle includes a review of the congestion in year 1 and year 5 and existing approved RTEP projects. This review will identify approved RTEP projects that may be accelerated or modified and meet the Market Efficiency Benefit/Cost criteria as explained in accompanying sections of this Manual 14B.

Long-term Market Efficiency planning is also completed as part of the development of the RTEP to identify solutions that require longer lead times to implement. As part of the 24-month Market Efficiency planning cycle, PJM initially develops a base case for years 1, 5, 8, 11, and 15 that are used to evaluate congestion for the long-term planning horizon. A higher level base case is developed for year 15 and may require a less detailed model of the transmission system below the 500 kV level as explained in section 2.6.5 of this manual. Proposed solutions to address Market Efficiency projected congestion are developed by stakeholders and PJM staff during the first year of the 24-month planning cycle. As shown in Exhibit 3, during the second year of the 24-month cycle, the base cases used for the long-term analysis during the first year (i.e., now year 0, 4, 7, 10, and 14) will be updated, as appropriate, to reflect the latest assumptions

regarding load, generation, demand response, transmission topology, or other input assumptions.

Congestion issues identified during the first year are validated and the proposed solutions are refined during the second year of the 24-month cycle. An independent consultant may be used to develop a cost estimate and evaluate the constructability of proposed solutions. Results from these long-term analyses are reviewed with the Transmission Expansion Advisory Committee throughout the 24-month planning process, and, ultimately, presented to the PJM Board of Managers for approval.

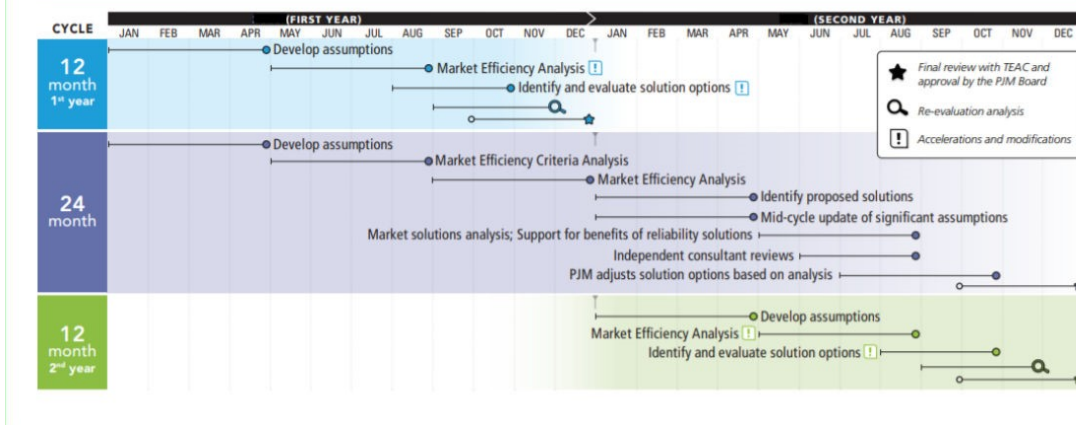

Exhibit 3: 24-Month Market Efficiency Cycle

2.1.4 Public Policy Planning

In parallel with the near-term and long-term reliability planning process described in section 2.1.2 above, upon request, PJM will perform scenario and sensitivity studies to identify transmission needs **that may be needed** to support a state’s selected public policies consistent with the Operating Agreement, Schedule 6, section 1.5.9 that **are have** not already **been identified included** in the reliability planning models, as well as inform actions to be taken to enhance and expand the transmission system, through either modifications of the in-service date of required transmission projects or identification of Multi-Driver Projects, as part of the base reliability planning scenario.

At the beginning of the 36-month long-term planning cycle, PJM will work with the TEAC, SRRTPEP, and ISAC committees and in accordance with the requirements of Schedule 6 of the Operating Agreement, to identify public policies to be examined as part of the reliability planning cycle. Once the assumptions are identified, and their inclusion determined by PJM, PJM can perform studies based on these requirements as outlined in the assumptions meetings. These studies will identify enhancements or expansions which may be needed to maintain reliability or for separate consideration by a state, or states, for development under the State Agreement Approach in accordance with the Operating Agreement, Schedule 6, section 1.5.9.

These processes may include informational scenario and/or sensitivity studies to help states seeking to enter into a State Agreement Approach enhancement or expansion of the transmission system. These additional studies are intended to help states determine whether to make a request, which may occur only for policies which can be determined to be Public Policy

Requirements as defined in the Operating Agreement, for PJM to open up a competitive transmission planning solicitation window to identify Long-lead Projects to support these potential State Agreement Approach projects. These competitive transmission planning windows will be **run-in-parallel coordinated** with the reliability planning windows in a holistic manner to identify transmission enhancements or expansions that participating states could voluntarily sponsor under the State Agreement Approach discussed in Operating Agreement, Schedule 6, section 1.5.9, that can be integrated into the RTEP. The decision of a state (or states) to not act on any studies related to State Agreement Approach enhancements or expansions, will not interfere with PJM moving forward with enhancements or expansion to maintain reliability.

2.2 The RTEP Process Drivers

The continuing evolution and growth of PJM's robust and competitive regional markets rests on a foundation of bulk power system reliability, ensuring PJM's ongoing ability to meet control area load-serving obligations. It also includes a commitment to enhance the robustness and competitiveness of Energy and Capacity markets by incorporating analysis and development of market efficiency projects. Schedule 6 of the PJM Operating Agreement describes the PJM RTEP process, governing the means by which PJM coordinates the preparation of a plan for the enhancement and expansion of the Transmission Facilities – on a reliable and environmentally sensitive basis and in full consideration of available economic and market efficiency factors and alternatives - in order to meet the demands for firm transmission service in the PJM region. PJM's FERC-approved RTEP process preserves this foundation through independent analysis and recommendation, supported by broad stakeholder input and approval by an independent RTO Board in order to produce a single RTEP.

The PJM Region transmission planning process is driven by a number of planning perspectives and inputs, including the following:

- ReliabilityFirst Regional Reliability Corporation¹ (RFC) Reliability Assessment – forward-looking assessments performed to assure compliance with NERC and applicable regional reliability corporation (ReliabilityFirst or SERC Reliability Corporation) reliability standards, as appropriate.
- SERC Reliability Corporation (SERC) Reliability Assessment
- PJM Annual Report on Operations – an assessment of the previous year's operational performance to assure that any bulk power system operational conditions which have emerged, e.g., congestion, are adequately considered going forward.
- PJM Load Serving Entity (LSE) capacity plans
- Generator and Transmission Interconnection Requests – submitted by the developers of new generating sources and new Merchant Transmission Facilities, these requests seek

¹ ReliabilityFirst, a new regional reliability corporation under the North American Electric Reliability Corporation (NERC), replaced three existing PJM-related reliability councils (ECAR, MAAC and MAIN) on January 1, 2006.

interconnection in the PJM Region (or seek needed enhancements as the result of increases in existing generating resources.)

- Transmission Owner and other stakeholder transmission development plans
- Interregional transmission development plans – the transmission expansion plans of those power systems adjoining PJM, and in some cases, beyond.
- Long-term Firm Transmission Service Requests
- Activities under the PJM committee structure especially, the Planning Committee (PC), the Transmission Expansion Advisory Committee (TEAC), the Subregional RTEP Committee, and local groups facilitated by PJM within the TEAC established processes (see section 1 “TEAC, Subregional RTEP Committee, and related planning activities”.)
- PJM Development of Economic Transmission Enhancements based on Economic and Market Efficiency factors
- Operational performance assessments and reviews such as the aging Infrastructure Initiative – a Probabilistic Risk Assessment of equipment that poses significant risk to the Transmission System.
- Inputs into the development of long-term regional transmission planning scenario and sensitivity assumptions reviewed with stakeholders.

The cumulative effect of these drivers is analyzed through the PJM Region transmission planning process to develop a single RTEP which recommends specific transmission facility enhancements and expansion on a reliable and environmentally sensitive basis and in full consideration of economic and market efficiency analyses. See Attachment B for details of the RTEP – Scope and Procedure.

Note:

The most recent version of the PJM RTEP is available PJM Web site at <http://www.pjm.com/planning/rtep-upgrades-status.aspx>.

These analyses are conducted on a continual basis, reflecting specific new customer needs as they are introduced, but also readjusting as the needs of Transmission Customers and Developers change. One such RTEP baseline regional plan will be developed and approved each year.

Note:

Generation withdrawals have the potential to impact study results for any generation or merchant transmission project that doesn't have an executed final agreement.

Generation retirements, depending on the date of the announced retirement, have the potential to impact study results for any generation or merchant transmission project that does not have an executed final agreement

Generation retirements included in interconnection project studies will be those announced as of the date a project enters the relevant Cycle, and consistent with the appropriate prior year's baseline annual reliability analyses.

In this way, the plan continually represents a reliable means to meet the power system requirements of the various Transmission Customers and Project Developers in a fully integrated fashion, at the same time preserving the rights of all parties with respect to the Transmission System. The assurance of a reliable Transmission System and the protection of the Transmission Customer/Developer rights with respect to that system coupled with the timely provision of information to stakeholders are the foundation principles of the PJM transmission planning process.

The PJM Region transmission planning process also establishes the cost responsibility for the following types of facility enhancements as defined in the PJM Tariff:

- Attachment Facilities
- Direct Assignment Facilities
- Network Upgrades (Direct and Non-direct)
- Distribution Upgrades
- Merchant Network Upgrades

Each RTEP encompasses a range of proposed power system enhancements: circuit breaker replacements to accommodate increased current interrupting duty cycles; new capacitors to increase reactive power support; new lines, line reconductoring and new transformers to accommodate increased power flows; and, other circuit reconfigurations to accommodate power system changes as revealed by the drivers discussed above.

Requests for interconnection of new generators or transmission facilities, while not the sole drivers of the PJM Region transmission planning process, are a key component of the RTEP.

Analyzing these requests has required adoption of an approach that establishes baseline system improvements driven by known inputs, followed by separate Cycle-defined, cluster-based impact study analyses. Overall, PJM's RTEP process – under a FERC-approved RTO model – encompasses independent analysis, recommendation and approval to ensure that facility enhancements and cost responsibilities can be identified in a fair and non-discriminatory manner, free of any market sector's influence. All PJM market participants can be assured that the proposed RTEP was created on a level playing field.

2.3 RTEP Reliability Planning

2.3.1 Establishing a Baseline

In order to establish a reference point for the annual development of the RTEP reliability analyses a 'baseline' analysis of system adequacy and security is necessary. The purpose of this analysis is threefold:

- To identify areas where the system, as planned, is not in compliance with applicable NERC and the applicable regional reliability council (ReliabilityFirst or SERC) standards, Nuclear Plant Licensee requirements and PJM reliability standards including equipment replacement and/or upgrade requirements under PJM's Aging Infrastructure Initiative. The baseline system is analyzed using the same criteria and analysis methods that are used for assessing the impact of proposed new interconnection projects. This ensures

that the need for system enhancements due to baseline system requirements and those enhancements due to new projects are determined in a consistent and equitable manner.

- To develop and recommend facility enhancement plans, including cost estimates and estimated in-service dates, to bring those areas into compliance.
- To establish the baseline facilities and costs for system reliability. This forms the baseline for determining facilities and expansion costs for interconnections to the Transmission System that cause the need for facilities beyond those required for system reliability.

The system as planned to accommodate forecast demand, committed resources, and commitments for firm transmission service for a specified time frame is tested for compliance with NERC and the applicable regional reliability council (ReliabilityFirst or SERC) standards, Nuclear Plant Licensee requirements, PJM Reliability Standards and PJM design standards. Areas not in compliance with the standards are identified and enhancement plans to achieve compliance are developed.

The 'baseline' analysis and the resulting expansion plans serve as the base system for conducting Phase I System Impact Studies for all proposed generation and/or merchant transmission facility interconnection projects and subsequent System Impact Studies.

2.3.2 Baseline Reliability Analysis

PJM's most fundamental responsibility is to plan and operate a safe and reliable Transmission System that serves all long term firm transmission uses on a comparable and not unduly discriminatory basis. This responsibility is addressed by PJM RTEP reliability planning. Reliability planning is a series of detailed analyses that ensure reliability under the most stringent of the applicable NERC, PJM or local criteria. To accomplish this each year, the RTEP cycle extends and updates the transmission expansion plan with a 15 year review. This cycle entails several steps. The following sections describe each step's assumptions, process and criteria. Attachments A through F of this manual add essential details of various aspects of the reliability planning process.

Reliability planning involves a near-term and a long-term review. The near-term analysis is applicable for the current year through the current year plus 5. The long-term review is applicable for the current year plus 6 through plus 15. Each review entails multiple analysis steps subject to the specific criteria that depend on the specific facilities and the type of analysis being performed.

The analysis is initiated following the completion of case builds and concludes with review by the TEAC and approval by the PJM Board (TEAC and the PJM Board are apprised regularly throughout the process and partial reviews and approvals of the plan may occur throughout the year.) The TEAC, Subregional RTEP and PJM Planning Committee roles in the development of the reliability portion of the RTEP are described in Schedule 6 of the PJM Operating Agreement.

2.3.3 Near-Term Reliability Review

The near-term reliability review (current year plus 5) provides reinforcement for criteria violations that are revealed by applicable contingency analysis. Limits used in the analysis are established

consistent with the requirements of NERC standards FAC-010 and FAC-014. The methodology used to determine system operating limits is included in Attachment-F of this manual. System conditions revealed as near violations will be monitored and remedied as needed in the following year near-term analysis. Violations that occur in many deliverability areas or severe violations in any one area will be referred to the long-term analysis for added study of possible more robust system enhancement. PJM annually conducts this detailed review of the current year plus 5. The annual review shall include system peak load for either year one or year two, and for year five.

For the annual evaluation of the near-term, sensitivity cases shall be utilized to demonstrate the impact of changes to the basic assumptions used in the model. To accomplish this, the sensitivity analysis in the Planning Assessment must vary one or more of the following conditions by a sufficient amount to stress the system within a range of credible conditions that demonstrate a measurable change in system response.

- Real and reactive forecasted load
- Expected transfers
- Expected in service dates of new or modified transmission facilities
- Reactive resource capability
- Generation additions, retirements, or other dispatch scenarios
- Controllable loads and demand side management

Duration or timing of known transmission outages

Each year of the period through the current year plus 4 (“in-close” years) has been the subject of previous years’ detailed analyses. In addition, for each of these “in-close” years, PJM updates and issues addendum to address changes as necessary throughout the year. For example planned generation modifications or changes in transmission topology can trigger restudy and the issuance of a baseline addendum. This is referred to as a “retool” study. (For example generators that drop from the Cycle cause restudy and an addendum to be issued for affected baseline analyses.) Also each year during the establishment of the assumptions for the new annual baseline analysis, current updated views of load, transmission topology, installed generation, and generation and transmission maintenance are assessed for the “in-close” range of years to validate the continued applicability of each of the “in-close” baseline analyses and resulting upgrades (including any addendum.) Adjustments in the “in-close” analyses are performed as deemed necessary by PJM. PJM, therefore, annually verifies the continued need for or modification of past recommended upgrades through its retool studies, reassessment of current conditions and any needed adjustments to analyses. All criteria thermal and voltage violations resulting from the near term analyses are produced using solved AC power flow solutions. Initial massive contingency screening may use DC power flow solution techniques.

There are seven steps in an annual near-term reliability review. They are:

- Develop a Reference System Power Flow Case
- Baseline Thermal
- Baseline Voltage

- Load Deliverability - Thermal
- Load Deliverability - Voltage
- Generator Deliverability - Thermal
- Baseline Stability

These reliability related steps are followed by a scenario analysis that ensures the robustness of the plan by looking at impacts of variations in key parameters selected by PJM. Each of these steps is described in more detail in the following material.

2.3.4 Reference System Power Flow Case

The reference power flow case and the analysis techniques comprise the full set of analysis assumptions and parameters for reliability analysis. Each case is developed from the most recent set of Eastern Reliability Assessment Group system models. PJM transmission planning revises this model as needed to incorporate all of the current system parameters and assumptions. These assumptions include current loads, installed generating capacity, transmission and generation maintenance, system topology, incorporation of the most recently finalized Local Plans and firm transactions. These assumptions will be provided to and reviewed by the Subregional RTEP Committee. The subregional modeling review and modeling assumptions meeting provides the opportunity for stakeholders to review and provide input to the development of the reference power system models used to perform the reliability analyses.

The results of any locational capacity market auction(s) will be used to help determine the amount and location of generation or demand side resources to be included in the reliability modeling. Generation or demand side resources that are cleared in any locational capacity market auction will be included in the reliability modeling, and generation or demand side resources that either do not bid or do not clear in any locational capacity market auction will not be included in the reliability modeling. All such modeling described here will comport with the capacity construct provisions approved by the FERC.

Subsequent to the subregional stakeholder modeling reviews facilitated by PJM, PJM will develop the final set of reliability assumptions to be presented to TEAC for review and comment, after which PJM will finalize the reliability review reference power flow. This model is expected to be available in early January of each year to interested stakeholders, subject to applicable confidentiality and CEI requirements, to facilitate their review of the results of the reliability modeling analyses.

2.3.5 Contingency Definitions

Contingency definitions used in RTEP analysis are the same as applicable NERC TPL contingency definitions. In addition to studying all contingency types listed in TPL-001 Table 1, PJM also studies bus tie breaker openings without a fault as a single contingency. Where the physical design of connections or breaker arrangements results in the outage of more than the faulted equipment when a fault is cleared, the additional facilities are also taken out of service in the contingency definition. For example, if a transformer is tapped off a line without a breaker, both the line and transformer are removed from service as a single contingency event.

Contingency definitions for double circuit tower line outages shall include any two adjacent (vertically or horizontally) circuits on a common structure, but shall exclude circuits that share

a common structure for one mile or less. The loss of more than two circuits on a common structure constitutes a NERC extreme event.

PJM will coordinate with adjacent Planning Coordinators and Transmission Planners to ensure that contingencies on adjacent systems which may impact their system are included in the contingency list.

2.3.6 Baseline Thermal Analysis

Baseline thermal analysis is a thorough analysis of the reference power flows for light load, summer and winter to ensure thermal adequacy based on normal (applicable to system normal conditions prior to contingencies) and emergency (applicable after the occurrence of a contingency) thermal ratings specific to the Transmission Owner facilities being examined. It is based on a 50/50 load forecast for the applicable period from the latest available PJM Load Forecast Report (50% probability that the actual load is higher or lower than the projected load.) It encompasses an exhaustive analysis of all single and common mode (NERC P0, P1, P2, P4, P5 and P7 events). Final results are supported with AC power flow solutions. Demand Response is not considered in the baseline analysis.

2.3.7 Baseline Voltage Analysis

Baseline voltage analysis parallels the thermal analysis. It uses the same power flow models for light load, summer and winter and examines voltage criteria for all the same NERC P0, P1, P2, P4, P5, and P7 set of single and common mode outage events.

Analysis will simulate the expected automatic operation of existing and planned devices designed to provide steady state control of electrical system quantities when such devices impact the study area. Those devices may include equipment such as phase-shifting transformers, load tap changing transformers, and switched capacitors and inductors. PJM examines system performance for both a voltage drop criteria (where applicable) and a voltage magnitude criteria. The voltage drop is calculated as the decrease in bus voltage from the initial steady state power flow to the post-contingency power flow. The post-contingency power flow is solved with generators holding a local generator bus voltage to a pre-contingency level consistent with specific Transmission Owner specifications. In most instances this is the precontingency generator bus voltage. Additionally, all phase shifters, transformer taps, switched shunts, and DC lines are locked for the post-contingency solution. SVC's are allowed to regulate and fast switched capacitors are enabled.

The voltage magnitude criteria is examined for the same contingency set by allowing transformer taps, switched shunts and SVC's to regulate, locking phase shifters and allowing generators to hold steady state voltage criteria (generally an agreed upon voltage on the high voltage bus at the generator location.)

In all instances, specific Transmission Owner voltage criteria are observed. All violations are recorded and reported and tentative solutions will be developed. These study results will be presented to and reviewed with stakeholders.

Post-Contingency voltage analysis shall also include the impact of tripping generators where the simulated generator bus voltages or the high side of the generation step up (GSU) transformer are less than known or assumed minimum generator steady state of ride through voltage

limitations. All violations will be reported and tentative solutions will be developed. The results of these studies will be reviewed through the TEAC.

2.3.8 NERC P3 and P6 “N-1-1” Analysis

Purpose

N-1-1 studies are conducted as part of the annual RTEP to determine if all monitored facilities can be operated:

- Within normal thermal and voltage limits after N-1 (single) contingency assuming redispatch and system adjustments, and
- Within the applicable emergency thermal ratings and voltage limits after an additional single contingency (N-1-1) condition.

All violations of the applicable thermal ratings are recorded and reported and tentative solutions will be developed. These study results will be presented to and reviewed with stakeholders.

Model

Annually, the N-1-1 study is conducted on a 50/50 non-diversified summer and winter peak case. The case building details are defined in Attachment C (C7 3.0 Step 1: Develop Base Case). Non-firm Merchant Transmission withdrawals can be removed. All BES facilities in PJM and ties to PJM will be monitored. In addition, non-BES facilities included in the real-time congestion management facility list will be examined on the light load case. Areas of the system that become radial post-contingency will be excluded from monitoring, with the following exceptions

- If the radial system contains greater than 300 MW of load, or
- Specific local TO Planning Criteria require that it be monitored.

Contingencies considered:

- All BES single contingencies as defined in NERC P3 and P6 as well as lower voltage facilities that are monitored by PJM Operations will be included in the assessment. Non-BES contingencies, defined by Transmission Owners, need to be included to check for greater than 300 MW load loss. Non-BES facilities that are included in the assessment will also have corresponding contingencies defined.

AC Solution Options in the PSS/E program:

- For the first single contingency (N-1 Condition) and to ensure the system remains within emergency thermal ratings o Transformer tap adjustment enabled o Switched shunt adjustment enabled
- After the first single contingency (N-1 Condition) and to return the system back within normal thermal ratings
 - Phase shifter adjustment enabled
 - System re-dispatched

- Topology changes implemented
- For the second single contingency (N-1-1 Condition) – Voltage Drop Test (if applicable)
 - Transformer tap adjustment disabled
 - Phase shifters locked to control angle, not flow
 - Switched shunt adjustment disabled except for fast switched capacitors
 - Generators are set to regulate their terminal bus
 - SVC's are allowed to regulate
 - Automatic shunt adjustment disabled
- For the second single contingency (N-1-1 Condition) – Thermal and Voltage Magnitude Test
 - Transformer tap adjustment enabled
 - Phase shifters locked to control angle, not flow
 - Switched shunt adjustment enabled
 - Automatic shunt adjustment enabled

PJM NERC P3 and P6 “N-1-1” Methodology

Thermal Test Methodology:

The PJM NERC P3 and P6 “N-1-1” Analysis will test the outage of every single contingency (N-1 condition)

The first step of the test is to ensure that post-contingency loadings of all facilities shall be within their emergency thermal ratings immediately following the first N-1 contingency

The second step of the test is to ensure that post contingency loadings of all facilities shall be within their normal thermal ratings after the first N-1 contingency and subsequent re-dispatch and system adjustments. Allowable system adjustments include generation dispatch, phase shifter adjustment, system reconfiguration and load throw-over.

The third step is to take the second N-1-1 contingency. Every second N-1-1 contingency is taken on every optimized N-1 scenario case to model the N-1-1 condition. After the second N-1-1 contingency, the thermal loading of any monitored facility that is above the applicable emergency thermal rating (long-term or short-term) is considered a reliability criteria violation and a mitigation plan will be needed.

Voltage Drop Test Methodology

The N-1-1 Voltage Drop Test procedure follows a similar method as the thermal test method, except all monitored facilities are monitored for the emergency voltage drop limit after the second contingency (N-1-1 condition.) The calculation of voltage drop is defined in section 2.3.7.

Voltage Magnitude Test

The N-1-1 Voltage Magnitude Test procedure follows a similar method as the thermal test method, except all monitored facilities are monitored for the emergency low and high limit after the second contingency (N-1-1 condition.)

Voltage Collapse

Voltage collapse is considered to be a severe reliability violation, and consequently each N-1-1 condition that exhibits voltage collapse needs to be investigated, validated, and resolved with remedial actions, or network upgrades. System Adjustments

Allowable System Adjustments following the first contingency (N-1 condition):

- Application of all effective actions and emergency procedures, with the exception of load shedding
- Redispatch using only PJM generators with capacity rights during the generation redispatch process
- Application of a PJM pool-wide generation availability rate during generator re-dispatch to ensure that the re-dispatch is statistically possible
- Un-faulted facilities in multiple facility outages may be restored
- Manual system switching and re-configuration
- Opening of transmission facilities
- Including bus-ties
- Closing of non-faulted transmission facilities
- Including bus-ties
- Adjustment of Static VAR Compensators (SVCs)
- Phase shifter adjustment
- Wind, solar, and other variable resources will be dispatchable up to their capacity delivery rights if they back off simulated facility loadings.
- The rest of resources can be either off line or dispatched between P_{min} and $(1 - \text{PJM generator average outage rate}) * P_{max}$

Allowable System Adjustments following the second contingency (N-1-1 condition):

No manual system adjustments permitted

2.3.9 Load Deliverability Analysis

The load deliverability tests are a unique set of analyses designed to ensure that the Transmission System provides a comparable transmission function throughout the system. These tests ensure that the Transmission System is adequate to deliver each load area's requirements from the aggregate of system generation. The tests develop an "expected value" of loading after testing an extensive array of probabilistic dispatches to determine thermal limits. A deterministic dispatch method is used to create imports for the voltage criteria test. The Transmission System reliability criterion used is 1 event of failure in 25 years. This is intended to design transmission so that it is not more limiting than the generation system which is planned to a reliability criterion of 1 failure event in 10 years.

Each load areas' deliverability target transfer level to achieve the transmission reliability criterion is separately developed using a probabilistic modeling of the load and generation system. The load deliverability tests described here measure the design transfer level supported by the Transmission System for comparison to the target transfer level. Transmission upgrades are specified by PJM to achieve the target transfer level as necessary. Details of the load deliverability procedure can be found in Attachment C.

Thermal

This test examines the deliverability under the stressed conditions of a 90/10 summer and winter load forecast. That is, a forecast that only has a 10% chance of being exceeded. The transfer limit to the load is determined for system normal and all single contingencies (NERC P0 and P1 criteria) under ten thousand load study area dispatches with calculated probabilities of occurrence. The dispatches are developed randomly based on the availability data for each generating unit. This results in an expected value of system transfer capability that is compared to the target level to determine system adequacy. As with all thermal transmission tests applied by PJM the applicable Transmission Owner normal and emergency ratings are applied. The steady state and single contingency power flows are solved consistent with the similar solutions described for the baseline thermal analyses.

Voltage

This testing procedure is similar to the thermal load deliverability test except that voltage criteria are evaluated and that a deterministic dispatch procedure is used to increase study area imports. The voltage tests and criteria are the same as those performed for the baseline voltage analyses.

2.3.10 Generator Deliverability Analysis

The generator deliverability test ensures that the Transmission System is capable of delivering the aggregate system generating capacity at summer peak load with all firm transmission service modeled. Additionally, to help ensure that generating resources are deliverable year round, expected generation output levels during light load and winter conditions are examined as part of the generator deliverability analysis. As a result, there are three separate periods examined as part of the generator deliverability analysis. The procedure ensures sufficient transmission capability in all areas of the system to export an amount of generation capacity at least equal to the amount of certified Capacity Resources in each "area". Areas, as referred to in the generator deliverability test, are unique to each study and depend on the electrical system characteristics that may limit transfer of Capacity Resources. For generator deliverability, areas are defined with respect to each transmission element that may limit transfer of the aggregate of certified installed generating capacity. The cluster of generators with significant impacts on the potentially limiting element is the "area" for that element. The starting point power flow cases for the light load, summer and winter are the same power flow case set up for the baseline analysis, but the applicable baseline load and ratings criteria apply for the period under consideration. The flowgates ultimately used in the reliability analysis are determined by running all contingencies maintained by PJM planning and monitoring all PJM market monitored facilities and all BES facilities. Single and common mode contingencies (NERC TPL P1, P2, P4 and P7) in PJM and just outside of PJM are examined during the generator deliverability analysis. Details of the generator deliverability procedure including methods of creating the study dispatch can be found in Attachment C.

2.3.11 Spare Equipment Strategy Review

PJM will annually evaluate the spare equipment strategy that could result in the unavailability of major transmission equipment that has a lead time of one year or more (such as a transformer) and assess the impact of this possible unavailability on system performance using NERC category P0, P1 and P2 contingency categories identified in Table 1 of NERC TPL-001-4. This assessment will consider the conditions that the system is expected to experience during the possible unavailability of the long lead time equipment.

2.3.12 Baseline Stability Analysis

PJM ensures generator and system stability during its interconnection studies for each new generator. In addition, PJM annually performs stability analysis for approximately one third of the existing generators on the system. Analysis is performed on the RTEP baseline stability cases. These analyses ensure the system is transiently stable and that all system oscillations display positive damping with damping ratio consistent with section G.2.2. Generator stability studies are performed for critical system conditions, which include light load and peak load for three phase faults with normal clearing plus single line to ground faults with delayed clearing. Also, specific Transmission Owner designated faults are examined for plants on their respective systems.

Finally, PJM will initiate special stability studies on an as needed basis. The trigger for such special studies commonly includes but is not limited to conditions arising from operational performance reviews or major equipment outages.

2.3.13 Extreme Event Review

The extreme review, identifies specific extreme contingencies as defined in Table 1 of NERC Standard TPL-001-4, and assess their impact on system reliability. If the initial analysis shows cascading caused by the occurrence of extreme events, PJM will perform an evaluation of possible action designed to reduce the likelihood or mitigate the consequences and adverse impacts of the event(s). This can include a stability analysis of the area and an evaluation of possible actions to reduce the likelihood of the event or mitigate the consequences and impacts on the system.

PJM will also assess the impact of extreme events using stability analysis. Extreme events contained in Table 1 of NERC TPL-001-4 that produce more severe impacts shall be identified and a list created of those events will be maintained and distributed to the appropriate entities. The rationale for those contingencies selected for evaluation shall be available as supporting information. If the initial analysis shows cascading by the occurrence of extreme events, PJM will perform an evaluation of possible actions designed to reduce the likelihood or mitigate the consequences and adverse impacts of the event(s).

2.3.14 Long-Term Reliability Review

The PJM RTEP reliability review process examines the long-term planning horizon, which spans the current year plus 6 through the current year plus 15, using a 36-month reliability planning cycle. During the first year of the cycle, 5, 8 and 15-year out seasonal base cases are developed. As part of the second year of the 36-month cycle, these base cases are evaluated against reliability criteria in order to identify transmission needs. Assumptions and model development regarding this long-term view will be presented and reviewed by the ISAC, and the TEAC during the first year of the 36-month cycle. The long-term view of system reliability is

subject to increased uncertainty due to the increased likelihood of changes in the assumptions used in the analysis for later years in the planning horizon. The purpose of the long-term review is to anticipate system trends, which may require longer lead time solutions. This enables PJM to take appropriate action when system issues may require initiation during the near-term horizon in anticipation of potential violations in the longer term. System issues uncovered that are amenable to shorter lead time remedies will be addressed as they enter into the near-term horizon.

Long-Term Reliability Analysis

The long-term reliability review involving single and multiple contingency analyses is conducted to detect system conditions which may need a solution with a lead-time exceeding five years. A review of the analytical results is performed to detect violations that occur for multiple locational deliverability areas (LDAs) or multiple or severe violations clustered in a one area of the system, focusing primarily on the magnitude, concentration and kV level of the violations. This review may suggest larger projects to collectively address groups of violations. All of the long-term results produced will be reviewed to determine if any issues may require longer lead time solutions. If so such needs will be included in a competitive transmission solicitation window and solutions will be determined and considered for inclusion in RTEP.

This evaluation of the need for longer lead time solutions considers NERC transmission planning criteria . Also this review considers that the long-term planning horizon exceeds the required NERC planning horizon. The main effect of this extension to 15 years is to examine a load level that is significantly higher than the base forecast year-five planning load level and capture forecast changes to the generation fleet and other expected system changes. To the extent that this long-term reliability review indicates marginal system conditions that may require a longer lead time solution, PJM will undertake additional longer-term sensitivity analyses as may be needed.

The long-term deliverability analyses are performed in a similar manner as the near-term load and generator deliverability analyses. The load deliverability case and the generator deliverability case load levels are set using the procedures described in Attachment C to this Manual except the year 8 and year 15 forecasts are used for the long-term forecasts as opposed to the year 5 forecast. Once the future generation fleet is determined using the assumptions developed during the beginning of the cycle, the generation dispatches are determined consistent with the methods for the near term analyses as well. The analysis for the long-term horizon focuses on conductor limits for transmission lines and evaluates NERC and PJM transmission planning criteria, as described in more detail below, against the same normal and emergency thermal ratings criteria used for the near term (subject to any upgrades that may be applicable for the longer term.)

Because the assumptions used in the year 8 models are more certain than those used in the year 15 models, and transmission needs identified in the year 8 models have less time to be addressed than the in the year 15 models, the year 8 analysis includes additional reliability criteria as detailed below and is broader in scope than the year 15 analysis.

- Year 8 deliverability thermal studies monitor the same facilities and contingencies as in the near-term analysis, but the year 15 deliverability thermal studies monitor only 230 kV and up and include only 230 kV and up single and tower contingencies.

- Year 8 N-1 voltage analysis monitors 230 kV and up facilities and includes all 230 kV and up contingencies, whereas year 15 N-1 voltage analysis is only performed as needed and monitors 500 kV and up facilities and includes only single and tower line 500 kV and up contingencies.
- Year 8 N-1-1 thermal and voltage analysis is restricted to 230 kV and up monitored elements and contingencies, whereas year 15 does not consider N-1-1 analysis.

Reactive analysis, as necessary from year to year, may also consider long-term upgrade sensitivity to key variables such as load power factor delivered from the Transmission System or heavy transfers. If uncovered violations are insufficient to justify acceleration of upgrades and are all amenable to shorter lead-time upgrades, then the violations will continue to be monitored in future RTEP analyses.

2.3.15 Stakeholder review of and input to Reliability Planning

RTEP reliability planning, through the operation of the TEAC and Subregional RTEP Committees, provides interested parties with the opportunity to review and provide meaningful and timely input to all phases of the reliability planning analyses. This section extends the Section 1 discussion of the TEAC and Subregional RTEP Committee process specifically as it relates to reliability planning. Exhibit 1 shows the workflow and timing for the reliability planning process steps. PJM anticipates at least two Subregional RTEP Committee reliability reviews. The initial subregional meeting will present and address reliability study assumptions and parameters. The second meeting will provide the opportunity for stakeholder comment and input on criteria violations and presentations of alternative remedies to identified violations. Between the two meetings PJM will provide feedback on interim study progress sufficient to enable stakeholder preparation for the second set of subregional meetings. Additional subregional meetings will be facilitated as PJM determines is necessary for adequate input and review. The relative timing of the TEAC and subregional activities are illustrated in Exhibit 1.

Subregional RTEP Committee initial assumptions meeting

This meeting is expected to occur in **December** of each year in preparation for the upcoming annual RTEP review. Prior to the meeting PJM will post its anticipated inputs and assumptions to enable stakeholder review and preparation for the meeting. At the meeting PJM will present the assumptions for discussion and input by all interested parties. Subsequent to this meeting stakeholders will have additional opportunity to provide input to PJM in preparation for the next TEAC meeting, at which PJM will present the final reliability assumptions for TEAC review. Although the initial Subregional assumptions meeting will discuss anticipated assumptions for both the reliability and market efficiency phase of the RTEP, the final TEAC review of each will likely occur at separate TEAC meetings (see also the market efficiency discussion following.) The TEAC review of final RTEP reliability assumptions, for near-term analyses, is expected to occur in early **January**. The TEAC review of final RTEP reliability assumptions, for long-term analyses, is expected to occur before the end of the first calendar year in the 36 month cycle.

PJM development of criteria violations and stakeholder participation

After the TEAC review of PJM's RTEP analysis assumptions, PJM will finalize its reference system power flow which is the starting point of its series of reliability analyses. This power flow is available to stakeholders subject to applicable confidentiality and CEII requirements.

PJM will perform its series of detailed RTEP reliability analyses encompassing the 15-year planning horizon. Details of the methods and procedures for the reliability analyses can be found elsewhere in this Manual 14B and its attachments. The five-year and longer time-frame criteria violations will be posted for review, evaluation and development of remedy alternatives by all interested parties. The PJM production of the near-term reliability analysis raw results is expected to occur about **January through July** of each year. Posting of the results and stakeholder review and consideration of alternative remedies for near-term analyses is expected to occur about **February through August** of each year. PJM will post TO and other stakeholder alternative upgrade remedies made available throughout this process. Throughout this time frame, TEAC typically has monthly or more frequent regularly scheduled meetings. PJM will periodically apprise TEAC of the progress of the violations identification and production of upgrade alternatives. Stakeholders may use these meetings to raise and discuss issues found in their reviews. Depending on the issues raised and input from stakeholders PJM may facilitate Subregional RTEP Committee meetings instead of or in addition to a scheduled TEAC meeting. These subregional meetings are intended for more focused review of subregional violations and alternative solutions.

Subregional RTEP Committee criteria violations and upgrade alternative meeting

This meeting is expected to occur, as may be necessary in various subregions, in the **July / August** timeframe each year. If a subregional meeting is unnecessary, the regularly scheduled TEAC meetings will provide the opportunity for that subregion's participants open discussion of violations and upgrades. In any event, all regional and subregional projects will be appropriately presented and reviewed at a TEAC meeting. Prior to a subregional violations and upgrade meeting, PJM will post the upgrade solutions that it proposes to remedy the identified criteria violations. At this subregional meeting PJM will present the reliability upgrades of specific violations and alternative upgrades as may be appropriate. By this Subregional RTEP Committee meeting, interested parties will have had the opportunity for ongoing participation in the **February through August** process of violation review and solution identification along with PJM and Transmission Owners. This subregional criteria violations and upgrade meeting is the forum for a final open discussion of the subregional reviews which have been occurring, prior to presentation to TEAC.

PJM TEAC Committee RTEP review

PJM expects that about **August** of each year, the final RTEP upgrade facilities will be available for presentation, review and feedback at a scheduled TEAC meeting. PJM will post its recommendations of RTEP upgrades for identified violations as early as possible in the month prior to the TEAC meeting at which the final RTEP facilities will be reviewed (see <https://www.pjm.com/committees-and-groups/committees/teac>). This posting will distinguish facilities that are deemed Supplemental RTEP Projects. After the TEAC RTEP review meeting, there will be about a month of additional time for final written comments on the proposed RTEP facilities, after which the PJM Board will consider the final RTEP plan excluding Supplemental Projects for approval.

2.3.16 Corrective Action Plan

PJM will prepare an annual Planning Assessment of its portion of the BES. For planning events shown in Table 1, when the analysis indicates an inability of the system to meet the performance requirements in Table 1, the Planning Assessment shall include Corrective

Action Plan(s) addressing how the performance requirements will be met. Revisions to the Corrective Action Plan(s) are allowed in subsequent Planning Assessments but the planned system shall continue to meet the performance requirements in Table 1. The Corrective Action Plan shall list system deficiencies and associated actions need to achieve required system performance. Examples of such actions include:

- Installation, modification, retirement or removal of Transmission and Generation facilities and any associated equipment
- Installation, modification or removal of Protection Systems or Remedial Action Schemes.
- Installation or modification of automatic generation tripping as a response to a single or multiple contingency to mitigate Stability performance violations.
- Installation or modification of manual and automatic generation runback/tripping as a response to a single or multiple contingency to mitigate steady state performance violations.
- Use of Operating Procedures specifying how long they will be needed as part of the Corrective Action Plan

Additionally, the Corrective Action Plan shall include action to resolve performance deficiencies identified in multiple sensitivity studies or provide a rationale for why actions were not necessary.

2.4 RTEP integrates Baseline Assumptions, Reliability Upgrades and Request Evaluations

PJM's robust energy market has attracted numerous requests from generator and transmission Project Developers for interconnections with the Transmission System. These Interconnection Requests constitute a significant driver of regional transmission expansion needs. This subsection discusses this driver in the context of the RTEP preparation. Details of this process are contained in Manual 14H.

Requests for Long Term Firm Transmission Service and generator deactivations are other types of request that are evaluated and incorporated into RTEP.

Demand Response (DR) can be a load response solution to the need for transmission upgrades. DR solutions enter the PJM process in the Reliability Pricing Model (RPM) through the associated base residual and incremental auctions. The DR cleared in the auction is included in the assumptions for RTEP development and physically modeled in the baseline power flows. In this manner, load can mitigate or delay the need for RTEP upgrades.

The RTEP process baseline analyses include previously processed generators and transmission modifications as starting point assumptions. The current year RTEP evaluations performed on this baseline case are incremental to the baseline and establish a "revised" baseline for the year of the annual RTEP analysis. This revised baseline forms the starting case for the reviews of new interconnection requests. The new interconnection request analyses result in system modifications beyond RTEP upgrades that are caused by interconnection requests. New interconnection request evaluations also include a review of their effects on newly approved RTEP upgrades that are not yet committed to construction. If previously identified RTEP upgrades can be delayed because of new interconnection requests, the

projects responsible for the upgrade deferrals will be credited for the benefits of the delayed need for the upgrades.

The RTEP integrates reliability upgrades, interconnection request upgrades and plan modifications and DR effects into a single process that accounts for the mutual interaction of the various market forces. In this way, transmission upgrades, interconnection requests and DR receive comparable treatment with respect to their opportunity to relieve transmission constraints.

Timing of Long-Term Firm Transmission Service Requests, and Generation and Transmission Interconnection Requests are based on the business needs of the party requesting the service. Such requests, therefore, enter the RTEP planning process throughout the RTEP planning year. Expansion plans that result from New Service Request evaluations are incorporated into the RTEP once a New Service Request's applicable final agreement has been executed. In addition, if needed to satisfy assumed planning reserve requirements for future planning year analyses, queue generators in earlier stages of the queue process may also be included. Only the queue generators with completed signed final agreements, however, are allowed to be used to alleviate constraints.

2.5 RTEP Cost Responsibility for Required Enhancements

The RTEP encompasses two types of enhancements: Network Reinforcements and Direct Connection Attachment Facilities. Network Reinforcements can be required in order to accommodate the interconnection of a merchant project (generation or transmission) or to eliminate a Baseline problem as a result of system changes such as load growth, known transmission owner facility additions, etc. Merchant project driven upgrades are addressed in Manual 14H. The cost responsibility for each baseline-revealed Network Reinforcement is borne by transmission owners based on the contribution to the need for the network reinforcement. Such costs are recoverable by each transmission owner through FERC-filed transmission service rates. Network reinforcements may also be proposed by PJM to mitigate unhedgeable congestion. Allocation procedures for Baseline and Market Efficiency upgrades are discussed in Attachment A.

Overall, the RTEP is best understood from the perspective of the studies that revealed the recommended Plan enhancements. To that end, the Baseline Analysis and Impact Studies identify the enhancements required to meet defined NERC and applicable regional reliability council (Reliability First or VACAR/SERC) standards, Nuclear Plant Licensee requirements and PJM reliability standards.

2.6 RTEP Market Efficiency Planning

Market efficiency analysis is performed as part of the overall PJM Regional Transmission Expansion Planning (RTEP) process to accomplish the following objectives:

- Identify new transmission enhancements or expansions that could relieve transmission constraints that have an economic impact.
- Review cost and benefits of economic-based transmission projects previously included in the Regional Transmission Expansion Plan (RTEP) to assure that they continue to be cost beneficial.

- Determine which reliability-based transmission projects, if any, have an economic benefit if accelerated or modified

Each year, as part of the 24-Month Market Efficiency Cycle, PJM performs a market efficiency analysis following the completion of the near-term reliability plan for the region. As a result, there is a mechanism in place for regularly identifying transmission enhancements or expansions that will relieve transmission constraints that also have an economic impact. Constraints that have an economic impact include, but are not limited to, constraints that cause: (1) significant historical gross congestion; (2) pro-ration of Stage 1B ARR; (3) significant future congestion as forecast in the market efficiency analysis; or (4) Reliability Pricing Model constraints identified in accordance to OATT Attachment DD Section 15.

In the market efficiency analysis, PJM will compare the costs and benefits of the economic-based transmission improvements. To calculate the benefits of these potential economic-based enhancements, PJM will perform and compare market simulations with and without the proposed accelerated reliability-based enhancements or the newly proposed economic-based enhancements for selected future years within the planning horizon of the RTEP. The relative benefits and costs of the economic-based enhancement or expansion must meet the benefit/cost ratio threshold test to be included in the RTEP recommended to the PJM Board of Managers for approval (This test and its implementation is described in detail in Attachment E.) PJM will present all the RTEP market efficiency enhancements to the TEAC Committee for review and comment. Subsequent to TEAC review, PJM will address the TEAC review and present the final RTEP market efficiency plan to the PJM Board, along with the advice, comments, and recommendations of the TEAC Committee, for Board approval.

2.6.1 Market Efficiency Analysis and Stakeholder Process

PJM's market efficiency analysis involves several phases. The process begins with the determination of the congestion drivers that may signal market inefficiencies. PJM will collect and publicly post relevant drivers. These metrics will be reviewed by PJM and all stakeholders to assess the system areas that are most likely candidates for market efficiency upgrades. In addition, PJM will perform market simulations to determine projections of future market congestion based on the anticipated RTEP upgraded system. This process facilitates concurrent PJM and stakeholder review of the same information considered by PJM in preparation for PJM's solicitation of stakeholder input for upgrades that may economically alleviate market inefficiencies. This solicitation of input will be at a Transmission Expansion Advisory Committee meeting. Following the evaluation of congestion drivers and solicitation of remedies, PJM will initiate an analysis phase which first examines the potential economic costs and benefits that may be associated with any upgrades specified during the reliability analysis. After this assessment, PJM will evaluate the economic costs and benefits of any identified new potential upgrades target specifically at economic efficiency. The following information looks at each of these phases in more detail.

2.6.2 Determination and evaluation of historical congestion drivers

Transmission solutions to mitigate congestion causing a pro-ration of existing or future Stage 1A ARR requests will be determined and recommended for inclusion in the RTEP with a recommended in-service date based on the 10-year Stage 1A simultaneous feasibility analysis results. This recommendation will also include a high-level analysis of the cost and economic benefits of the upgrade as additional information but such upgrades will not be subject to market

efficiency cost/benefit analysis. More information on the ARR allocation auction process can be found in Manual 6.

Congestion causing pro-ration of Stage 1B ARR requests will be addressed using the “with and without” analysis and the benefit/cost ratio threshold described previously in this market efficiency material.

2.6.3 Determination of projected congestion drivers and potential remedies

PJM will provide all stakeholders with estimates of the projected congestion by performing annual hourly market simulations of future years using a commercially available market analysis software modeling tool (see assumptions and criteria material in Section 1.) This simulation will produce and PJM will post projected binding constraints, binding hours, average economic impact of binding constraints, and cumulative economic impact of binding constraints for the four RTEP market efficiency analyses.

At this time PJM will also facilitate a TEAC meeting, as appropriate, to review congestion and solicit feedback from the stakeholders’ review of the projected congestion data. All stakeholders can provide input to PJM’s consideration of the congestion data to be considered for market efficiency solutions to identified economic issues.

Parties wishing formally to submit proposals to address congestion as identified in the Market Efficiency Analysis may do so as described in section 2.6.7 of this manual.

2.6.4 Evaluation of cost / benefit of advancing reliability projects

PJM will perform annual market simulations and produce cost / benefit analysis of advancing reliability projects. An initial set of simulations will be conducted for current year plus 1 and current year plus 5 using the “as is” transmission network topology without modeling future RTEP upgrades. A second set of simulations will be conducted for each year using the as planned RTEP upgrades. A comparison of the “as is” and “as planned” simulations will identify constraints which have caused significant historical or simulated congestion costs but for which an as-planned upgrade will eliminate or relieve the congestion costs to the point that the constraint is no longer an economic concern. A comparison of these simulations will also reveal if a particular RTEP upgrade is a candidate for acceleration or expansion. For example, if a constraint causes significant congestion in year 1 but not in year 5 then the upgrade which eliminates this congestion in the year 5 simulation may be a candidate for acceleration. The benefit of accelerating this upgrade would then be compared to the cost of acceleration as described below before recommendation for acceleration is made.

When the reliability project economic acceleration analyses have been completed, PJM will schedule a TEAC or Subregional Committee meeting, as appropriate, to review the results. The timing of this meeting will depend, to some extent, on the amount and complexity of analysis that must be performed. However, it is anticipated that this meeting will take place during the **fourth quarter** of each year. At this meeting PJM will provide a summary of the analysis results, including an update of the Market Efficiency analysis and a description of any recommendations for accelerating reliability projects based on economic considerations.

2.6.5 Determination and evaluation of cost / benefit of potential RTEP projects specifically targeted for economic efficiency

PJM will perform market simulations and produce cost / benefit analysis of projects specifically targeted for economic efficiency. The benefit component of the cost / benefit analysis (Total Annual Enhancement Benefit) could consist of an energy market benefit, a Reliability Pricing Model (RPM) benefit, or both if the project addresses both energy market and RPM constraints. The net present value of annual benefits will be calculated for the 15 year period starting with the RTEP year defined as current year plus 5 minus benefits for years where the project is not yet in service. The net present value of annual benefits will be compared to the net present value of the upgrade revenue requirement for the same 15 year period.

2.6.5.1 Determination of Energy Market Benefits

An initial set of simulations will be conducted for each of four years for the current 24-month cycle (current year plus 1, current year plus 5, current year plus 8 and current year plus 11) using the as planned transmission network topology and the as planned generation expansion as defined by the most recent RTEP. A second set of simulations will be conducted for each of the four years using the as planned transmission network topology plus the upgrade being studied. The upgrade will be included in each of the four simulation years regardless of the actual anticipated in-service date of the upgrade. A comparison of these simulations will identify the benefit of the upgrade in each of the four years analyzed. The simulated benefits will provide a forecast of annual upgrade benefits for each of the anticipated first 15 years beginning from the RTEP year. Annual benefits within the 10-year time frame for years which were not simulated would be interpolated using these simulation results. A forecast of annual benefits for years beyond the 10-year simulation time frame would be based on an extrapolation of the market simulation results from the studied years. A higher-level annual market simulation will be made for future year 15 to validate the extrapolation results and the extrapolation of annual benefits for years beyond the 10-year simulation time frame may be adjusted accordingly. This high level simulation of future year 15 may require a less detailed model of the transmission system below the 500 kV level.

2.6.5.2 Determination of Reliability Pricing Model (RPM) Benefits

To determine RPM benefits, PJM will perform and compare RPM simulations with and without the upgrade for the RPM year (current year plus 3) and the RTEP year (current year plus 5). A comparison of these simulations will identify the annual economic impact of the upgrade for each of these study years. A forecast of annual benefits for years beyond the RTEP year will be based on a linear extrapolation of the market simulation results from the studied years.

2.6.5.3 Determination of Benefits/Cost ratio

An extrapolation of the simulation results will provide a forecast of annual upgrade benefits for each of the 15 years, beginning from the RTEP year. The present value of annual benefits projected for the 15 year period starting with the RTEP year defined as current year plus 5 minus benefits for years where the project is not yet in service will be compared to the present value of the upgrade revenue requirement for the same period to determine if the upgrade is cost beneficial and recommended for inclusion in the PJM RTEP. For informational purposes only, when comparing competing projects PJM will set the annual revenue requirement for projects not yet in service to zero and include annual benefits as a negative number to reflect

loss of benefits to PJM. If the ratio of the present value of benefits to the present value of costs exceeds 1.25 then the upgrade is recommended for inclusion in the RTEP.

When the economic efficiency project evaluations have been completed, PJM will schedule a TEAC meeting, as appropriate, to review the results. The timing of this meeting may depend on the amount and complexity of analysis that must be performed. At this meeting PJM will provide a summary of the analysis results, including an update of the Market Efficiency analysis.

2.6.6 Determination of final RTEP market efficiency upgrades

PJM will perform a combined review of the accelerated reliability projects and new market efficiency projects that passed the economic screening tests to determine if there are potential upgrades with electrical similarities. This may result in new projects to replace the original projects to form a more efficient overall market solution. PJM will evaluate the cost / benefits of any such resulting “hybrid” projects². The final list of reliability projects and market efficiency projects, including any “hybrid” projects will be presented and discussed at a TEAC meeting. At this TEAC meeting PJM will review all the Market efficiency plans resulting from this cycle of market efficiency studies. Recommended projects will be taken to the PJM Board for endorsement, and will either be included in subsequent RTEP analysis if there is a “volunteer” to build the project, or a report will be filed with FERC in accordance with Schedule 6 of the PJM Operating Agreement. As part of this request for endorsement, PJM will provide the written comments submitted by the parties, and will discuss these written comments with the PJM Board.

Within the limits of confidential, market sensitive, trade secret, and proprietary information, PJM will make all of the information used to develop the Market Efficiency recommendations available to market participants to use in their own, independent analyses.

For each enhancement which is analyzed, PJM will calculate and post on its website changes in the following metrics on a zonal and system-wide basis: (i) total energy production costs (fuel costs, variable O&M costs and emissions costs); (ii) total load energy payments (zonal load MW times zonal load Locational Marginal Price); (iii) total generator revenue from energy production (generator MW times generator Locational Marginal Price); (iv) Financial Transmission Right credits (as measured using currently allocated Auction Revenue Rights plus additional Auction Revenue Rights made available by the proposed acceleration or modification of a planned reliability-based enhancement or expansion or new economic-based enhancement or expansion); (v) marginal loss surplus credit; and (vi) total capacity costs and load capacity payments under the Reliability Pricing Model construct.

For each market efficiency project proposed for RTEP, PJM will also post, as soon as practical, the following:

- Anticipated high-level project schedule and milestone dates

² Hybrid transmission upgrades include solutions which encompass modification to reliability-based enhancements already included in RTEP that when modified would relieve one or more economic constraints. Such hybrid upgrades resolve reliability issues but are intentionally designed in a more robust manner to provide economic benefits in addition to resolving those reliability issues.

- Final commitment date after which any change to input factors or drivers will not result in transmission project deferral or cancellation.

After this TEAC meeting, any member of the TEAC can provide written comments within sixty (60) days of this meeting. These written comments will consist of three (3) sections:

- Introduction, which will describe the party submitting the comments and their reason for submitting these comments
- Summary, which will consist of no more than 3 pages summarizing the positions described in the written comments
- Discussion, which will consist of no more than 20 pages describing in detail the positions taken by the party

2.6.7 Submitting Proposals

Any TEAC member or other entity (consistent with PJM Operating Agreement Schedule 6 provisions), may formally submit proposals for evaluation under the Market Efficiency analysis within the RTEP proposal window. These proposals will be posted on the PJM Website. Market Efficiency Proposals will not be accepted for acceleration or modifications to existing approved RTEP projects.

Regardless of all proposals considered – whether proposed by PJM or other parties - PJM will establish a “go/no-go” decision-point deadline (or final commitment date) after which existing RTEP transmission components will not be deferred or cancelled. This will provide certainty to developers, owners and investors.

2.6.8 Ongoing Review of Project Costs

To assure that projects selected by the PJM Board for Market Efficiency continue to be economically beneficial, both the costs and benefits of these projects will be reviewed on an annual basis. Substantive changes in the costs and/or benefits of these projects will be reviewed with the TEAC at a subsequent meeting to determine if these projects continue to provide measurable economic benefit and should remain in the RTEP.

For Market Efficiency projects included in the RTEP with capital costs under \$20M, PJM will not be required to reevaluate both updated costs and benefits annually if the project’s benefit/cost ratio remains at or above 1.25, using the original benefits. However, if the benefit/cost ratio of such projects falls below 1.25 based on PJM’s annual review of the project’s updated cost estimate, PJM will reevaluate the need for the project using both updated cost estimates and benefits.

PJM will no longer be required to review updated costs and benefits of a market efficiency project once the certificate of public convenience and necessity or its equivalent is granted by the state in which the facilities will be located. If no certificate of public convenience and necessity or its equivalent is required by the state in which the transmission facilities will be located, PJM will no longer be required to review updated costs and benefits of a market efficiency project once the project commences construction activities at the project site. Notwithstanding the foregoing, PJM reserves the right to reevaluate any project.

For projects with a total cost exceeding \$50 million, an independent review of project costs and benefits will be performed to assure both consistency of estimating practices across PJM and

that the scope of the project is consistent with the project as proposed in the Market Efficiency analysis.

2.7 Evaluation of Operational Performance Issues

As per Schedule 6, section 1.5 of the PJM Operating Agreement, PJM is required to address operational performance issues and include system enhancements, as may be appropriate, to adequately address identified problems. To fulfill this obligation, PJM Transmission Planning staff and Operations Planning staff annually review actual operating results to assess the need for transmission upgrades that would address identified issues. Typical operating areas of interest in these reviews include Transmission Loading Relief (TLR), Post Contingency Local Load Relief Warning (PCLLRW) events, and persistent uplift payments.

The first operational performance issue to be addressed through the RTEP was an upgrade of the Wylie Ridge 500/345 kV transformation. The metric applied to designate Wylie Ridge an operational performance issue was the TLR metric. This same metric is applied consistently across the PJM footprint.

In addition, PJM has also developed and initiated use of a tool for Probabilistic Risk Assessment (PRA) of transmission infrastructure. PJM's 500/230 kV transformer infrastructure has been identified as particularly suited for assessment using this tool. PRA is further discussed in following sections.

2.7.1 Operational Performance Metrics

Events and metrics considered in the annual operational performance reviews are not limited to a specifically defined list and will be responsive to events and conditions that may arise. In addition, PJM stakeholders may raise operational issues to PJM's attention for consideration during the RTEP process through interactions with the Planning, TEAC or Subregional RTEP Committees.

The PJM TLR metric identifies facilities that result in over 1,000 hours or 100 occurrences of TLR level 3 or higher on an annual basis. These facilities will be evaluated through the RTEP process for system enhancement.

For PCLLRW events, PJM will review all such events after the conclusion of the peak season. The initiating facilities will be determined and the expected impacts of planned RTEP upgrades will be reviewed and the need for additional planned upgrades will be evaluated.

For Uplift payments, PJM will annually review the persistent uplift payments and the system condition or driver for the payment. PJM will assess the impact of planned RTEP upgrades on the drivers for the uplift and the need for additional planned upgrades will be evaluated. The evaluation of the need for additional upgrades will consider the frequency and amount of the uplift payment as well as any outage or short term system conditions that may have caused the uplift. Upgrades will be considered to mitigate uplift payments that are expected to continue in the future.

PRA evaluation uses an economic analysis of the cost of the investment that mitigates a risk and the dollar value of the avoided risk. The mitigation strategy cost, prime rate and payback period are used to determine if the strategy cost is less than the value of risk. Projects with lower cost than risk are candidates for the RTEP.

2.7.2 Probabilistic Risk Assessment of PJM 500/230 kV Transformers

One significant element of PJM’s operational performance reviews involves a risk evaluation aimed at anticipating significant transmission loss events. PJM integrates aging infrastructure decisions into the ongoing RTEP process: analysis, plan development, stakeholder review, PJM Board approval, and implementation, over PJM’s entire footprint. Thus, the aging infrastructure initiative implements a proactive, PJM-wide approach to assess the risk of transmission facility loss and to mitigate operational and market impacts of such losses.

PRA’s initial implementation at PJM is a risk management tool employed to reduce the potential economic and reliability consequences of transmission system equipment losses. In collaboration with academia, vendors and member TOs, PJM integrated various input drivers into a transformer PRA initiative to manage 500/230 kV transformer risk. In the case of the 500/230 kV transformers, risk is the product of the probability of incurring a loss and the economic consequence of the loss. Probability of loss is determined based on the individual transformer unit’s condition assessments and vintage history. Economic loss impact is based upon the duration of the loss and the accumulation of unhedgeable congestion costs, or the increased cost of running out of merit generation to meet load requirements after a transformer loss. If lead times for 500/.230 kV transformer units are as great as eighteen months, then outage durations can be long if adequate loss mitigation is not in place. The PRA outputs the annual risk to the PJM system of each transformer unit in terms of dollars. The annual risk dollars are then used to justify mitigating solutions such as redundant bank deployment, proactive replacement or adding spares. The deployment strategy chosen will depend on the level of risk mitigation and reliability benefit.

While initially developed for aging 500/230 kV transformers, the PRA tool is capable of assessing other equipment types and other transformer voltage classes. The PRA tool is commercially available software.

2.8 End of Useful Life Issues

For each transmission need identified pursuant to FERC Form No. 715 or other Transmission Owner planning criteria addressing the end of useful life of an existing facility, which, in accordance with good utility practice, is not determined by the facility’s service life for accounting or depreciation purposes, each Transmission Owner should provide information, to the extent available, that supports the need for the project consistent with the Transmission Owner’s planning criteria in accordance with the RTEP process or Attachment M-3 Process, as applicable.

2.9 Critical Substation Planning Analysis

PJM will evaluate all proposed system reinforcements, consistent with RTEP critical substation planning analysis methods incorporated in cascading trees tool software. This analysis is performed as part of the 5 year annual RTEP cycle, as described in Section 2.3.3 of this manual, to determine if any projects addressing other drivers cause concern from a critical substation planning analysis perspective.

Critical substation planning analysis is performed to identify Instability, Uncontrolled Separation, or Cascading resulting in one or more of the following outcomes due to the loss of all voltage

levels 69 kV and above at a single transmission facility that has an "aggregate weighted value" exceeding 3000 according to the table below. The "aggregate weighted value" for a single station or substation is determined by summing the "weight value per line" shown in the table below for each incoming and each outgoing BES Transmission Line that is connected to another Transmission station or substation:

Voltage Value of a Line	Weight Value per Line
Less than 200 kV (not applicable)	(not applicable)
200 kV to 299 kV	700
300 kV to 499 kV	1300
500 kV and above	0

1. Loss of load approaching 1000 MW

- Includes consequential load loss and tripped load
- Total loss of load should be considered

1. Three levels of facility trips

- Includes line, transformers and generators
- Tripped elements should include 69kV and above facilities.

1. Case fails to converge after tripping of facilities, assuming non-convergence isn't due to modeling issues or load pockets

If a proposed project fails the critical substation planning analysis, PJM may modify the technical specifications of a proposal so that it avoids a failure of the critical substation planning analysis (CSPA), as defined above in this Section 2.9. This may result in the modified proposal being determined to be the more efficient or cost-effective proposal for recommendation to the PJM Board.

Attachment A: PJM Baseline Reliability Upgrade Cost Allocation Procedures

A.1 Purpose

One of the responsibilities of PJM as an RTO is to allocate the cost responsibility for all system reinforcement projects including projects required for Customer interconnection requests and baseline transmission reliability upgrades. Manual 14A addresses request-driven upgrade cost allocation procedures. The cost allocation procedures used by PJM for baseline reliability upgrades are described below. The methodology in Schedule 12 of the PJM Tariff that is the bases of these cost allocation procedures was developed and filed by the PJM Transmission Owner and approved by FERC for PJM implementation.

A.2 Scope

The PJM Cost Allocation Procedures are presented in two parts: “PJM Generation and Transmission Interconnection Cost Allocation Methodologies” discusses the cost allocation methodology for projects required for generator and transmission interconnections in Manual 14A and: “Schedule 12 Cost Allocation Process for Baseline Transmission Reliability” describes the cost allocation methodology and procedures for baseline transmission reliability projects.

A.3 Schedule 12 Cost Allocation Process for Baseline Transmission Reliability Upgrades

In addition to allocating the costs of interconnection projects (described above), PJM is responsible, under Schedule 6 of the Operating Agreement and Schedule 12 of the Tariff, for determining the cost allocation of all RTEP baseline reliability upgrades and submitting them to the PJM Board for approval. Allocation of transmission upgrades for reliability is beneficiary based. With respect to reliability projects, while a definitive benefit is from the elimination of a reliability criteria violation, the benefit quantified for the purpose of cost allocation is the use of the upgrade by PJM load zones. The usage of the reliability project by a PJM load zone relative to the usage by all other PJM load zones will be used to determine the percentage cost responsibility to be assigned to the zone. As the usage changes with system topology changes, PJM shall recalculate the cost allocation percentage on an annual basis

A.3.1 RTEP Baseline Reliability Upgrade Cost Allocation

PJM’s allocation of cost responsibility for RTEP reliability baseline upgrades in accordance with these provisions is beneficiary based. Typically, load growth creates conditions that constitute violations of reliability criteria, which in turn require upgrades for eliminating the violations. The benefit to load from elimination of the violation will differ from the benefit of having the resultant upgrade available for use to deliver PJM generation to serve them. However, the benefit derived by the load in a transmission zone can only be determined by the use of the upgrade to deliver PJM generation to this load zone relative to similar uses of the upgrade by other zonal loads. This quantifiable benefit is then used to determine the relative responsibility for the cost of the system upgrade(s) for each zone.

To the extent that a criteria violation is based on the thermal limits of a transmission facility, the cost allocation is based directly on the relative use of the upgrade facility by the load in each zone. However, for criteria violations based on voltage criteria, thermal surrogates are developed and employed for the allocation such that the flow on the surrogate (i.e., a transmission facility or group of facilities) best correlates to the reactive performance of the system at the point of the criteria violation. The same approach described above is then utilized to simulate the relative use of the thermal surrogates. Accordingly, the cost allocation for the solution to the voltage criteria violation is based on the relative use of thermal surrogates by load in each zone.

Under this approach to cost allocation, it is entirely possible, and certainly consistent with the allocation philosophy, that the costs of upgrades in one transmission zone may be allocated in significant part to load in other transmission zones. While many required transmission upgrades are allocated entirely to load within the same zone where the criteria violation and the related upgrade are located, the nature of large, integrated transmission systems like the PJM system is such that transmission facilities in one area can be used significantly to serve loads in other areas. The planning process identifies the most effective solutions to criteria violations and the resultant use of these solutions by loads may not be related to the physical location of the transmission upgrade. Therefore, responsibility for the costs of baseline reliability upgrades likewise shall be allocated to those who use these solutions, regardless of their physical location relative to the location of the baseline reliability upgrade required to ensure the reliability of their service.

The basic categories of baseline reliability upgrades and the associated cost allocation procedures can be summarized as follows:

Regional and Necessary Lower Voltage Facilities with estimated costs greater than or equal to \$5 million

50% of the cost of the upgrade will be assigned annually on a load-ratio share using the PJM Network Transmission Service Peak Load and the applicable load values for Merchant Transmission having Firm Transmission Withdrawal Rights for the 12-month period ending October 31 preceding the calendar year for which the annual cost responsibility allocation is determined

50% of the cost of the upgrade will be assigned annually on a directionally-weighted solution-based DFAX methodology

Lower Voltage Facilities with estimated costs greater than or equal to \$5 million

100% of the cost of the upgrade will be assigned annually on a directionally-weighted solution-based DFAX methodology

The above allocation method accounts for the bi-directional hourly use of the upgrade. The percentage of net energy flow on the facility in each direction will be determined via an 8,760 hourly production cost simulation. Those load zones having distribution factors that indicate they contribute to power flow on the facility in the same direction as the net energy flow from the production cost simulation will be responsible for the portion of the cost assigned to the use of the upgrade in that direction.

Lower Voltage Facilities with estimated costs below \$5 million

100% of the cost will be assigned to the zone where the upgrade is to be located

The basic steps of the directionally-weighted, solution-based DFAX methodology are:

- Obtain peak MW loads from the most recent PJM load report

Calculate the Distribution Factor (DFAX) for each transmission zone and merchant transmission facility with firm withdrawal rights based on its use of the upgrade to deliver PJM generation to serve its load. PJM will use the annual RTEP starting base case to develop all DFAX values for new RTEP upgrades. Other than the addition of new RTEP upgrades, the starting base case will not be modified during the year. A DFAX represents a measure of the use of the upgrade by each MW of a zone's load served by a MW of PJM generation, as determined by power flow analysis. The source used for the DFAX calculation is the aggregate of all PJM generation and the sink is each Transmission Owners peak zonal load or applicable MW values for a merchant transmission with firm withdrawal rights. The import objective to the Locational Deliverability Areas (LDA) in which the transmission zone is located will also be considered during DFAX calculation as follows. In modeling the system generation and load, the percentage of the zonal load in the LDA served by external (or internal) generation to the LDA is the external (or internal) Participation Factor and shall equal the ratio of (i) the CETO associated within that LDA (or generation internal to the LDA) to (ii) the sum of (a) the internal generation within the LDA and (b) the CETO associated with that LDA. For the generation dispatch used in calculating the distribution factor, PJM shall distribute these amounts of external/internal generation among all generation in the PJM Region external to/internal within the LDA, respectively, in proportion to their capacity.

The following example demonstrates the usage of CETO in the calculation of the internal and external Participation Factors described above. In LDA 1, for example, 66.67% of the zonal load in the LDA is served by internal generation and 33.33% of the zonal load in the LDA is served by external PJM generation.

Table 1 - CETO Application in Participation Factor Calculation for Cost Allocation

AREA	LDA 1	LDA 2	LDA 3	LDA 4
CETO (MW)	3,000	6,000	< 0	3,000
Actual Capacity (MW)	6,000	3,000	6,000	0
Internal Participation Factor	66.67%	33.33%	100.00%	0.00%
External Participation Factor	33.33%	66.67%	0.00%	100.00%

- Apply a DFAX threshold of 0.01 such that and DFAX with a magnitude less than 0.01 will be set to zero.

Select the DFAX with the lowest magnitude for zones with more than one DFAX for a particular upgrade as these zones are embedded in multiple LDAs.

- Multiply each DFAX by each zonal peak load to determine the zone’s use of the upgrade in the direction indicated by the sign of the DFAX.
 - o Sum the MW use of the upgrade corresponding to the same directional use of the upgrade.
 - o Calculate the percentage use by each zone in each direction.
- Perform a separate 8,760 hour production cost simulation to determine the expected total energy (MH-Hour) use of the upgrade in each direction for the simulated year.
- Calculate the weighting factor (in percent) for each directional use of the upgrade.
- Calculate the cost allocation percentage from the solution-based DFAX method by multiplying the percentage use of each zonal load in each direction with the weighting factor having the same directional use of the upgrade.

RTEP Baseline Reliability Upgrade Cost Allocation Representative Example

The following representative example illustrates the cost allocation steps.

Step	Reference	Zone 1	Zone 2	Zone 3	Zone 4	Zone 5	Total
1. Peak Load (MW)	From PJM Load Report	10,000	6,000	4,000	3,000	2,000	25,000
2. DFAX	From DFAX Analysis	0.050	-0.100	0.009	-0.030	0.100	
2a. Apply DFAX Threshold	Set DFAX < 0.01 to 0	0.050	-0.100	0	-0.030	0.100	
2b. Select lowest DFAX		0.050	-0.100	0	-0.030	0.100	
3. Zonal Use of the Upgrade	Line 1 * Line 2b	500	(600)	-	(90)	200	
3a. Zonal Use in [+] Direction		500	-	-	-	200	700
3a. Zonal Use in [-] Direction		-	(600)	-	(90)	-	(690)
3b. % use in [+] Direction	Line 3a / Line 3a Total	71.43%				28.57%	100%
3b. % use in [-] Direction	Line 3a / Line 3a Total	-	86.96%	-	13.04%	-	100%
4a. Weighting Factor in [+] direction	From Production Cost simulation	80%	-	-	-	80%	
4a. Weighting Factor in [-] direction	From Production Cost simulation	-	20%	-	20%	-	
5. Calculate cost allocation Percentage	Line 3b * Line 4a	57.14%	17.39%	-	2.61%	22.86%	100%

*For regional and Necessary Lower Voltage facilities greater than or equal to \$5 Million, the allocation for each LDA will be the average of the DFAX allocation and the LDA load ratio share based on the appropriate Network Service Peak Loads.

Attachment B: Regional Transmission Expansion Plan—Scope and Procedure

B.1 Purpose

The purpose of the Regional Transmission Expansion Plan (RTEP) is to develop plans which will assure reliability and meet the demands for firm transmission service in the PJM Region as described in Schedule 6 of the Operating Agreement.

B.2 Scope

As part of its ongoing responsibility, PJM Interconnection, LLC (PJM) will prepare a Regional Transmission Expansion Plan (RTEP) which shall consolidate the transmission needs of the region into a single plan. The RTEP shall reflect transmission enhancements and expansions, load and capacity forecasts, and generation additions and retirements for the ensuing five years. The RTEP shall also reflect new transmission construction required to support load growth accounting for generation additions and retirements, economic and public policy considerations, consistent with the Operating Agreement, Schedule 6, section 1.5.3.

The RTEP will:

- Provide a 5-year plan (“near term plan”) to address needs for which a commitment to expand or enhance the transmission system must be made in the near term in order to meet scheduled in service dates.
- PJM will develop the necessary documentation of previous year’s RTEP analyses and updates to demonstrate compliance with applicable criteria. Such documentation may include the most recent Baseline study for each year in the near-term planning horizon (current year through current year plus 5,) annual changes to each year’s baseline study assumptions for generation, transmission and load compared to the current year’s assumptions for each respective study year, and retool studies to evaluate and ensure compliance with applicable standards and criteria for significant changes proposed to the system (Interconnection and New Service Requests.) The need for additional baseline retools will be considered and any needed restudy will be performed and reported. Retool analysis is used to review previously established assumptions, later in the planning cycle, as those assumptions may have changed.
- Provide a 15-year plan (“long term plan”) to address new longer lead time transmission construction and right-of-way acquisition given forecasted load growth and other inputs concerning the resource mix. Provide an assessment based on maintaining the PJM region’s reliability in an economic manner.
- Avoid any unnecessary duplication of facilities.
- Avoid the imposition of unreasonable costs on any Interconnected Transmission Owner (ITO) or any user of transmission facilities.
- Take into account the legal and contractual rights and obligations of the Interconnected Transmission Owners.

- Provide, if appropriate, alternative means for meeting transmission needs in the PJM Region.
- Provide for coordination with existing transmission systems and with appropriate interregional and local expansion plans.
- Include a designation of the Interconnected Transmission Owner or Owners or other entity that will own a transmission facility and how all reasonably incurred costs are to be recovered.
- Identify local system limitations discovered in analyzing the Transmission System.
- Include scenario planning evaluations. Scenario planning examines the long-term impacts on the reliability of the PJM system from uncertainty with respect to certain assumptions implicit in the development of the RTEP. PJM will work with the Independent State Agencies Committee (ISAC), the Transmission Expansion Advisory Committee (TEAC), and Subregional RTEP (SRRTEP) to carry out its obligation under the Operating Agreement to develop and review the assumptions to be used in the scenario planning procedure. PJM shall determine the final set of assumptions to be included in all studies. PJM will examine the effects of uncertainty with respect to selected variables such as economic growth effect on the load forecast, circulating transmission flow effects on system deliverability and generation scaling sensitivities.
- Include Probabilistic Risk Assessment (PRA) of Aging Transmission System Infrastructure beginning in 4Q, 2006. PRA is employed to mitigate transformer risk on the bulk power system. The consequences of a failure, both reliability and economic impacts, are then considered to implement, when appropriate, a proactive, PJM-wide approach to mitigate operational and market impacts to such failures.

The RTEP will not:

- Include an evaluation of Transmission Owner transmission expansion or enhancement plans for local area load supply, which are not needed for reliability, market efficiency or operational effectiveness of the Transmission System and do not otherwise negatively impact the Transmission System. These Transmission Owner projects (Supplemental Projects) will be identified in the RTEP for information purposes and tracked for possible future impact implications.
- Include any upgrades based solely on scaling up of generation to solve load flow studies for years 6 through 15.

B.3 Procedure

Solicit input and coordinate with Transmission Expansion Advisory Committee (TEAC) and, as appropriate, TEAC's Subregional RTEP Committee.

- Present the preliminary results of the most recent, applicable NERC regional reliability council (ReliabilityFirst and SERC) Reliability Assessments and the most recent PJM Regional Transmission Expansion Plan (RTEP).

- Present a summary of the transmission expansion or enhancement needs that will be addressed in the RTEP.
- Provide periodic updates to the TEAC on status of the RTEP.
- Solicit input on future transmission needs and requirements from those who will not be contacted directly as listed below.
- Schedule and facilitate Subregional RTEP committee reviews as may be needed to foster the goal of a transparent and participatory planning process.

Identify known Transmission System expansion or enhancement needs from the following plans and analysis results:

- Most recent, applicable Reliability Assessments (ReliabilityFirst and SERC) – (on PJM website)
- Most recent PJM Annual Report on Operations – (on PJM website)
- PJM Load Serving Entity (LSE) capacity plans
- Generator and Transmission Interconnection Requests
- Transmission Owner transmission plans
- Interregional transmission plans.
- Firm Transmission Service Requests
- PJM Transmission Expansion Advisory Committee (TEAC) and Subregional RTEP Committee input
- PJM Development of Economic Transmission Enhancements

PJM will consider the RTEP impacts of each Generation Project Developer (“GPD”) and/or Transmission Project Developer that is currently engaged in discussion with PJM concerning plans for siting generating and/or transmission facilities.

- Typical items to be included are as follows:
 - o GPD and/or Merchant Transmission Facilities developer project status, schedule, and milestones.
 - o PJM will review the status of studies currently being performed or scheduled to be performed by PJM for the GPD and/or Merchant Transmission Facilities developer.
- GPD and/or Merchant Transmission Facilities developer plans will be included in the RTEP based on the following criteria:
 - o Developer must be presently engaged in discussion with PJM concerning their plans for siting generating and/or transmission facilities and actively pursuing those plans. Interconnection Studies in response to requests for Generator and/or Transmission Interconnections will be conducted in accordance with the following scope:

- Identify transmission enhancements required to meet reliability requirements over the next 5 years.
- No studies will be conducted beyond 5 years for interconnection projects.
- “But-for” costs will be applicable toward all system upgrades identified in the RTEP Baseline.
- GPD and/or Merchant Transmission Facilities developer plans will be treated equal to LSE plans submitted via EIA 411 in that they will be explicitly modeled and explicitly included in the RTEP report.
- GPD and/or Merchant Transmission Facilities developer plans, which have not been released publicly, will be masked to the greatest extent possible to preserve the confidentiality of the developer’s identity and specific site location(s).
- GPD and/or Merchant Transmission Facilities developer plans, which were developed as a result of a PJM Phase I System Impact Study or are being developed in conjunction with a PJM Phase I System Impact Study being performed concurrent with the RTEP process, will be evaluated explicitly during the RTEP.
- GPD and/or Merchant Transmission Facilities developer plans which have not undergone a PJM Phase I System Impact Study or are not actively being developed as a result of an agreement executed with PJM to perform a Phase I System Impact Study concurrent with the RTEP process, will only be considered to the extent that the GPD generator installation or Merchant Transmission Facilities developer facility may affect the sensitivity of transmission enhancement or expansion alternatives which are being evaluated.

PJM will exchange information and data with each Transmission Owner (TO) for the purpose of developing RTEP assumptions in preparation for the Subregional RTEP Committee assumptions meeting. Typical items to be included are as follows:

- TOs will verify their transmission and capacity plans.
- TOs and PJM will discuss the status, impact, and schedule of relevant studies in which they are mutually engaged in performing.
- TOs will provide information concerning the contractual rights and obligations which PJM must consider per the RTEP protocol as listed in Schedule 6 of the PJM Operating Agreement.
- TOs will provide PJM with any information related to concerns, operating procedures, or special conditions for each of the TO’s systems that PJM should consider related to the analysis to be performed for the RTEP.
- TOs will discuss the accuracy of PJM’s load flow representation for each of the TO’s systems including the impact of using the present representation for each of the TO’s underlying systems.
- TOs will identify system needs which are currently not identified by published transmission plans but could be included for consideration during the RTEP analysis.

- TOs will provide the names, addresses, telephone numbers, FAX number, and email address for personnel identified to interact with PJM on matters dealing with the RTEP process.
- TOs will provide a confidentiality statement regarding all information released to the TO by PJM during the course of the RTEP process.
- TOs will provide information on new loads or changing loads that will impact the transmission plan.

PJM will include available information from neighboring TOs / Regional Transmission Operators, gained in the course of interregional planning activities, related to plans in other regions which may impact the PJM RTEP.

RTEP Analysis General Assumptions:

- PJM System Models will be drawn from the PJM and applicable regional reliability council (ReliabilityFirst and SERC) central planning database which includes transmission plans consistent with the most recent FERC 715 Report and most recent Regional EIA-411 Reports.
- LSE capacity models are to be based on the most recent Regional EIA-411 Reports.
- GIC capacity plans will be modeled as described in Procedures III and IV.
- When the PJM load in the RTEP model exceeds the sum of the available in-service generation plus generation with an executed final agreement, PJM will model new generation to accommodate additional load growth by including queued generation that has received a Phase II System Impact Study. PJM will model additional generation as needed to support the forecast load in the 15-year horizon.
- PJM Load Forecasts are to be based on the most recent LAS Report.
- Power Flow models for world load, capacity, and topology will be based on the most recent Eastern Reliability Assessment Group (ERAG) power flow base cases.
- Generation outage rates will be based on the most recent generator unavailability data available to PJM. Estimates, based on historical outage rates for similar in-service units, will be used for all generating units in the neighboring regions and for all future PJM units.
- Firm sales to, and firm purchases from, regions external to PJM will be modeled consistent with the provisions for the interchange schedule as outlined in section H.1.2 of Attachment H to this manual.
- Only PJM's share of generation will be modeled to serve PJM load. Generation located within PJM, but not committed to PJM, will be accounted for in the interchange schedule.
- The Reliability Principles and Standards as shown on Attachment D to this Manual 14B, "PJM Reliability Planning Criteria."
- Stability analysis and short circuit studies will also be performed.

- All PJM Transmission System facilities 100 kV and greater, and all tie lines to neighboring systems will be monitored.
- Contingency analysis will include all facilities operated by PJM.
- The published line and transformer daytime thermal ratings at ambient temperatures of 50F (10C) winter, 95F (35C) summer and 59F (15C) light load will be used as the default rating sets for all facilities. PJM will apply alternate Transmission Owner ambient temperature rating sets wherever variations exist.
- The voltage limits applied for planning purposes will be the same as applied in PJM Operations for both normal and single contingency scenarios. For non-single contingency scenarios that are not covered in TO criteria, the voltage limits used in PJM Operations will apply.
- PJM/NYISO PAR Flows: Model 15% of the PJM to NYISO firm interchange, exclusive of merchant transmission facilities, on the Waldwick PARs, 7% on the Goethals and Farragut PARs, and 32% on the Ramapo PARs. In addition, model 80% of RECO load on the Ramapo PARs.
- Assumptions used for the economic analysis and comparison of alternatives will be included in the report.
- Planning and Markets will, annually based on historical data, develop a circulation model to be applied to the 5 year RTEP base case. This assumption will be reviewed with the PJM Planning Committee prior to implementation.

Evaluate Transmission enhancement and expansion alternatives and develop a coordinated Regional Transmission Expansion Plan.

- Develop solution alternatives for regional and subregional transmission needs.
- Evaluate solutions on a regional basis and optimize solutions to address needs on a coordinated regional basis in a single plan.
- Test the single regional plan for reliability, economy, flexibility, and operational performance based on forecasts for future years.

RTEP Deliverables

- A 5-year plan, which includes recommended regional transmission enhancements, including alternatives if applicable, that address the transmission needs for which commitments need to be made in the near term in order to meet scheduled in-service dates.
- The 5-year plan will include planning level cost estimates and construction schedules.
- The 5-year plan will specify the level of budget commitments which must be made in order to meet scheduled in-service dates. The commitment may include facility engineering and design, siting and permitting of facilities, installation or modification of metering system(s) required by Manual 01, or arrangements to construct transmission enhancements or expansions.

- The 15-year plan will identify new transmission construction and right-of-way acquisition requirements to support load growth and the forecast resource mix.

Attachment J contains the checklist for the new equipment energization process to be utilized by Transmission Owners and Designated Entities from inception to energization of upgrade projects.

B.4 Scenario Planning Procedure

Beginning in mid-2006, PJM will include scenario planning evaluations as part of the RTEP process. Scenario planning examines the long-term impacts on the reliability of the PJM system due to uncertainty with respect to certain assumptions implicit in the development of the RTEP. PJM will examine the effects of uncertainty with respect to selected variables such as economic growth effect on the load forecast, circulating transmission flow effects on system deliverability and generation sensitivities. In the course of the RTEP planning cycle scenario planning will evaluate Transmission System requirements, as may be necessary to ensure the robustness of the RTEP. The following sensitivities will be considered:

- Load forecast for economic growth
 - o The current 90/10 load values only account for weather uncertainty and do not consider economic growth deviations. An economic growth sensitivity may consider the effects of high economic growth factors and higher than forecast loads to determine the impact on RTEP baseline upgrades identified for years 6 through 10 for:
 - Eastern PJM Mid-Atlantic Region (PSE&G, JCP&L, PECO, Delmarva, AE and RECO).
 - Southwestern PJM Mid-Atlantic Region (PEPCO and BG&E).
 - Western PJM Mid-Atlantic Region (MetEd, PPL, UGI and Penelec).
 - PJM Western Region (ComEd, AEP, Dayton, Duquesne, AP, ATSI, DEOK and EKPC).
 - PJM Southern Region (Dominion).
 - o System upgrades identified as required in years 6 through 10 may be advanced if the initiating overload occurs in an earlier year due to the high economic growth factor scenario.
- Circulation
 - o Circulation assumptions included in the RTEP baseline analysis will be reviewed for appropriate sensitivities.
- Public policy considerations
 - o PJM will work with the Independent State Agencies Committee (ISAC) and the Transmission Expansion Advisory Committee (TEAC), as required by the Operating Agreement, Schedule 6, section 1.5.6, to identify Public Policy Requirements and Public Policy Objectives to be considered for inclusion in the scenario planning

process and ~~in-order~~ to clarify the impacts of state policies on existing and future generation, as well as any electrification policies. This includes, but is not limited to, consideration of Public Policy Requirements and Public Policy Objectives for modeling load, retirements and generation additions in the scenario planning processes. Following these discussions, PJM will determine changes to the assumptions, which will be included in the various scenarios, including scenarios to maintain reliability, or inform decisions relating to a state engaging in State Agreement Approach enhancements or expansions in accordance with Operating Agreement, Schedule 6, section 1.5.9.

- Generation sensitivities
 - o When the PJM load in the RTEP model exceeds the sum of the available in-service generation plus generation with an executed final agreement, PJM will model new generation to accommodate additional load growth by including queued generation that has received a Phase II System Impact Study. This newly added generation could affect the load deliverability results either by advancing or mitigating limits. Generation sensitivities may be examined as appropriate to add information regarding the impacts of any such generators with less certain in-service dates. In addition, in areas that are experiencing load deliverability issues, sensitivities to the mitigating effects of new local generation may also be quantified.
 - o PJM will analyze the results of any generation sensitivities for consideration of adjustments to any new transmission system needs previously identified in the RTEP for years 6 through 15.
- Additional Information
 - o For any overloads that resulted in transmission system needs in years 6 through 15, PJM will provide the level of new generation or DSM per region that would eliminate the need for the transmission.

Attachment C: PJM Deliverability Testing Methods

C.1 Introduction

C.1.1 Purpose of Deliverability Requirements

Schedule 10 of the PJM Reliability Assurance Agreement states that Capacity Resources must be deliverable, consistent with a loss of load expectation as specified by the Reliability Principles and Standards, to the total system load, including portion(s) of the system in the PJM Control Area that may have a capacity deficiency at any time. Certification of deliverability means that the physical capability of the transmission network has been tested by the Office of the Interconnection and found to provide service consistent with the assessment of transfer capability internal to PJM as set forth in the PJM Tariff and, for Capacity Resources owned or contracted for by a Load Serving Entity, that the Load Serving Entity has obtained Network Transmission Service or Firm Point-to-Point Transmission Service to have capacity delivered on a firm basis under specified terms and conditions.

PJM determines the installed capacity requirements for the entire PJM footprint assuming sufficient network transfer capability will exist to ensure deliverability of these resources. In order to satisfy this assumption, the energy from generating facilities that is ultimately committed to meet this capacity requirement must be deliverable within PJM to wherever it is needed.

Deliverability ensures that the transmission system within PJM can be operated within applicable reliability criteria and ensures within those criteria that regional load will receive energy, with no guarantee as to price, from the aggregate of Capacity Resources available to PJM as demonstrated in the applicable planning studies.

C.1.2 Types of Deliverability Requirements

To maintain reliability in a competitive capacity market, Capacity Resources must contribute to the deliverability of energy within PJM in two ways. First, within an area experiencing a localized capacity emergency, or deficiency, energy must be deliverable from the aggregate of the available Capacity Resources to load. This type of deliverability is referred to as load deliverability. Failure of load deliverability tests will result in the initiation of appropriate mitigation actions, including securing additional Capacity Resources or an enhancement to the Transmission System, in order to increase the area's ability to import power.

Second, Capacity Resources within a given electrical area must, in aggregate, be able to be exported to other areas of PJM. This type of deliverability is referred to as generator deliverability. The generator deliverability test determines whether a generator qualifies for the status of a certified Capacity Resource with respect to the installed capacity obligations imposed under the Reliability Assurance Agreement. It does not guarantee any rights to specific generators to deliver energy to specific loads within PJM. Nor does it guarantee any rights to generators to produce energy during any particular set of operational circumstances. Failure of the deliverability test for a new Capacity Resource will result in denial of full capacity rights for the generator until such generator deliverability deficiencies are corrected.

These deliverability tests ensure that the PJM Transmission System is adequate for delivery of energy from the aggregate of Capacity Resources to the aggregate of PJM load. PJM has

developed comprehensive testing methodologies to verify compliance with each of these deliverability requirements.

C.2 Load Deliverability

C.2.1 Overview of Load Deliverability

C.2.1.1 Purpose of Load Deliverability

The first of these deliverability tests involves confirming that within accepted probabilities the Transmission System can support the delivery of energy from the aggregate of available PJM Capacity Resources to PJM electrical areas experiencing a capacity deficiency. This test is often discussed in the context of demonstrating deliverability to the load as opposed to deliverability of individual generation resources.

To ensure the adequacy of the generating capacity of the entire PJM footprint, the acceptable loss of load expectation (LOLE) is based on load exceeding available capacity, on average, not more than one occurrence in ten years (1/10). This concept of deliverability to load coincides with the assumptions inherent in the determination of the PJM Installed Reserve Margin (IRM), i.e. the total amount of installed capacity necessary to be at the disposal of the PJM operator to ensure delivery of energy to load consistent with an LOLE of 1/10. The determination of the IRM is based on the assumption that the delivery of energy from the aggregate of available Capacity Resources to load within the PJM footprint will not be limited by transmission capability. This assumption depends on the existence of a balance between the distribution of generation throughout PJM and the strength of the Transmission System to deliver energy to portions of PJM experiencing capacity deficiencies.

C.2.1.2 Locational Deliverability Areas

To test the deliverability assumptions inherent in the development of the PJM Installed Reserve Margin, electrically cohesive load areas must first be defined. The historical implementation of this test based these areas on Transmission Owner service territories and larger geographical zones comprised of a number of those service territories. Current study areas also include the definition of smaller areas within service territory boundaries. Twenty-seven Locational Deliverability Areas (LDAs) have thus far been identified including five global LDAs, which are geographical combinations of Transmission Owner service territories, and three sub-LDAs, which are portions of Transmission Owner service territories.

PJM will analyze the need for the addition of an LDA if such a need is identified through either the RTEP market efficiency or other RTEP long-term planning studies. Constrained facilities identified utilizing market efficiency studies that are not resolved by an existing approved RTEP upgrade are identified for further consideration. In addition, future constrained facilities identified utilizing the RTEP long-term planning studies may also result in the need for the addition of a new LDA. These future constrained facilities are screened using thresholds that are included in the RTEP long-term planning studies. This analysis is updated annually based on approved RTEP upgrades. 500 kV and above constrained facilities or other sets of critical facilities that advance more than three years between RTEP cycles are identified for further consideration. If the driver for such constraints advancing more than three years is linked to a specific event (e.g. significant generation retirement), it may require further analysis and the creation of a new LDA.

Once a constrained facility or group of constrained facilities has been identified under these criteria, distribution factor analysis is performed to determine the specific busses to be included in the proposed LDA. The model used to determine the distribution factors will include all approved RTEP upgrades. The specific distribution factor cutoff to be used in the development of a new LDA will be dependent upon an analysis of the specific system topology, generation and load characteristics in the vicinity of the identified constrained facility(s).

C.2.1.3 General Assumptions

C.2.1.3.1 Independent Study Area Generation Capacity Deficiency

For the purposes of analysis, each LDA within PJM is assumed to be experiencing a generation deficiency independently. Thus, the remainder of PJM is assumed to be operating normally and able to supply the study area with emergency power up to the limit of its available reserves. Load in all other PJM areas beyond the area under test will be modeled at 50/50 load level.

C.2.1.3.2 Consistency with PJM Emergency Operations Procedures

In all cases, the study area CETL analysis should reflect actual PJM emergency operations procedures designed to make as much power available to the deficient study area as possible under the prevailing system conditions. This should include but is not limited to

- The operation and redispatch of any available PJM generation external to the LDA regardless of system economics. Redispatch of Capacity Resources are allowed internal to the study area as well to relieve an overload provided that the CETO is increased by the amount of generation reduction required to eliminate the internal overload.
- The activation of any PJM Load Management (LM) schemes within the LDA that may serve to unload limiting facilities to the extent that doing so does not reduce the load in the area under test below the expected 50/50 load.
- The adjustment of any Phase Angle Regulators (PARs) which PJM or PJM member companies control within existing agreements for emergency operation. The PJM/NYISO PAR flows will be set according to Attachment B Section (B.3)(VII)(P).
- The activation of any approved PJM or PJM member company operating procedure. Operating procedures are described in PJM Manual M03 -Transmission Operations.

C.2.1.4 General Procedures

The load deliverability procedures are consistent with the changing nature of load responsibility under wholesale and retail access and provide a wide range of information about the performance of the Transmission System as electrical areas of different sizes are evaluated. The sequence of evaluating areas of differing size involves nesting small sub-areas into larger areas and finally areas into larger geographical areas of PJM to help identify the interrelationships between local and large geographical area deliverability problems.

The specific procedures utilized to test deliverability from the load perspective involve the calculation of both Capacity Emergency Transfer Objectives (CETO) and Capacity Emergency Transfer Limits (CETL) for the various electrical areas of PJM. A CETO value represents the amount of energy that a given area must be able to import in order to remain within an LOLE of 1 event in 25 years (1/25) when that area is experiencing a localized capacity emergency. The LOLE calculation takes into account all generation within the study

area including that which may not be a PJM Capacity Resource. The CETL represents the actual ability of the Transmission System to support deliveries of energy to an electrical area experiencing such a capacity emergency. Provided that the CETL for a given area exceeds the CETO for that area, the test is passed and, on a probabilistic level, the area will be able to import sufficient energy during emergencies. The Transmission System is tested at a LOLE of 1/25 so that the transmission risk does not appreciably diminish the overall target of a 1/10 LOLE for PJM.

After an LDA is defined, two generation patterns must be established. The first represents the Capacity Resource deficiency within the LDA. Based on the calculated CETO for the LDA, sufficient resources must be removed from service to create a need to import energy into the LDA. As the magnitude of the deficiency is adjusted, single contingency analysis is used to establish the CETL value. The second generation pattern required represents the dispatch of the remainder of PJM and surrounding non-PJM areas, and is comprised of a much larger number of generators that are not experiencing any emergency conditions. The larger area in PJM is modeled as experiencing only normal levels of unit outages simulated through existing RTEP base case procedures (see also “Deliverability of Generation”).

Both thermal and voltage studies under single contingency conditions are performed at the CETO to determine potential overload conditions and substations with voltage issues. For each LDA, two different dispatches at the CETO import level are examined. The first dispatch is based on a probabilistic approach whereby up to 10,000 different generation outage scenarios within the study area are simulated to create a statistically-based Mean Dispatch Case. The second dispatch uses a combination of discrete generator outages and scaled generator outputs in the LDA to create a Discrete Outage Case.

C.2.2 Current Locational Deliverability Area Definitions

A study area, also referred to as a Locational Deliverability Area (LDA), area may consist of a single PJM transmission owner’s transmission system (345 kV and below for the Mid-Atlantic system) with its connected load and generation. The study area may also consist of a portion of such an LDA. In both of these cases, the study area is referred to as a Zonal study area. A study area may also consist of a geographical combination of various transmission systems (with all connected load and generation) sharing common bulk facilities for importing power. Study areas comprised of combinations of Zonal study areas are referred to as Global study areas. Assessment of both Zonal and Global study areas will identify the most restrictive emergency import margins with respect to reliability criteria and deliverability of Capacity Resources to load within the PJM footprint.

PJM Global CETL Study Areas

Eastern Mid-Atlantic Area – Comprises all load and generation connected 500 kV and lower in PECO, PSE&G, JCP&L, Delmarva, AE, and RECO.

Southern Mid-Atlantic Area – Comprises all load and generation connected 500 kV and lower in BG&E and PEPSCO.

Western Mid-Atlantic Area – Comprises all load and generation connected 500 kV and lower in Penelec, Met-Ed, PP&L and UGI.

Mid-Atlantic Region – Comprises all load and generation connected 500 kV and lower in Penelec, Met-Ed, PP&L, UGI, BG&E, PEPCO, PECO, PSE&G, JCP&L, Delmarva, AE and RECO.

Western Region – Comprises all load and generation connected 765 kV and lower in ComEd, ATSI, AEP, Dayton, DEOK, Duquesne, AP, OVEC, and EKPC. Note that CPP is within the ATSI transmission Zone.

PJM Zonal CETL Study Areas

Penelec – All load and generation connected at 345 kV and below.

AP – All load and generation connected at 500 kV and below.

ATSI – All load and generation connected at 345 kV and below.

Cleveland – All load and generation connected at 345 kV and below as defined in Figure E-3

DEOK – All load and generation connected at 345kV and below.

EKPC – All load and generation connected at 345 kV and below.

Met-Ed - All load and generation connected at 230 kV and below.

PP&L - All load and generation connected at 230 kV and below.

BG&E - All load and generation connected at 230 kV and below.

PEPCO - All load and generation connected at 230 kV and below.

JCP&L - All load and generation connected at 230 kV and below.

PECO - All load and generation connected at 230 kV and below.

AE - All load and generation connected at 230 kV and below.

PSE&G - All load and generation connected at 345 kV and below.

Delmarva - All load and generation connected at 230 kV and below.

ComEd - All load and generation connected at 765 kV and below.

AEP - All load and generation connected at 765 kV and below.

Dayton - All load and generation connected at 345 kV and below.

Duquesne - All load and generation connected at 345 kV and below.

Dominion – All load and generation connected at 500 kV and below.

Delmarva South - All load and generation connected at 230 kV and below as defined in Figure E-1.

PSE&G North - All load and generation connected at 345 kV and below as defined in Figure E-2.



Figure E-1 (Delmarva South)

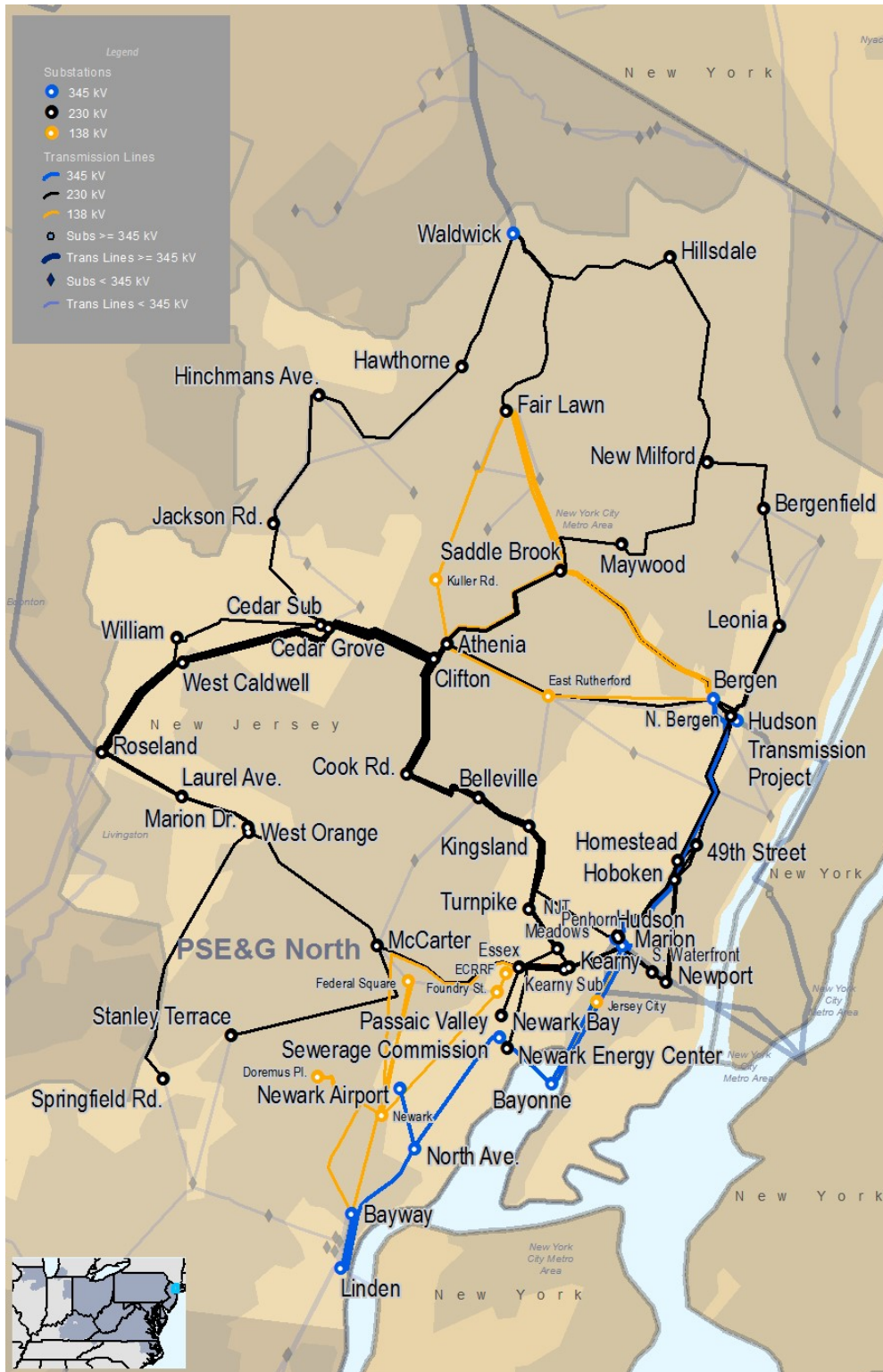

Figure E-2 (PSE&G North)



Figure E-3 (Cleveland LDA)

C.2.3 Base Case Development

Two separate base case models are developed as necessary; a PJM summer peak case to study summer-peaking study areas and a PJM winter peak case to study winter-peaking study areas. The RTEP load flow case nearest to the study time period should be selected and modified as required (modeling the projected load, generation, interchange and transmission system configuration for the target study period).

C.2.3.1 Load Deliverability Area Assumptions

The study area being evaluated is assumed to be experiencing a generation emergency due to a combination of higher-than-expected load demand (a 90/10 load forecast) and greater-than-expected generator unavailability. The 90/10 load forecast level is modeled by using the value of the 90/10 load contained in the latest PJM Load Forecast Report along with generator outage scenario(s) that would lead to a generation emergency inside the LDA and thereby potentially cause a transmission import limitation. All Capacity Resources in the LDA are initially modeled online and then generator outage scenarios are developed.

To calculate plausible generator outage scenarios, a file containing the installed MW capacity and the five-year planning equivalent forced outage rate demand (EFORd) for every PJM Capacity Resource will be developed. The EFORd are developed using the Generator Availability Data System (eGADs). Information related to eGADs can be found at <http://pjm.com/markets-and-operations/etools/egads.aspx>.

Below is a list of additional assumptions that are made when setting up and analyzing the LDA.

- Behind the Meter and energy only generation should be modeled at the average historic MW output during the previous year's 10 highest load hours for the study area each hour being selected from a different day. If this historic information is not available, then these units will be turned off in the power flow model and not included in the load deliverability study.
- Merchant Transmission Facilities, capable of meeting the requirements under the PJM Tariff to obtain Firm Transmission Withdrawal Rights, will be modeled at the greater of their long-term firm transmission service reservation value or Firm Transmission Withdrawal Rights. Refer to Exhibit 3.
- No study areas will be defined with less than a peak load of 1500 MW.
- Generator reactive output will be reduced in proportion to the MW scaling reduction for any generation that is modeled below the rated capability.
- The 90/10 load adder is assumed to be at 0.8 power factor.
- Normal and emergency ratings included in the power flow will be those applied in Operations (at 35C).
- PARs located within PJM may be operated as needed subject to the appropriate agreements (if any) and PJM Operating Company practices. The PJM/NYISO PAR flows will be set according to Attachment B Section (B.3) (VII) (P).
- If the forecast 90/10 MW load minus the available DR (MW) is less than the 50/50 MW load, then the 50/50 MW load will be used in the area being tested. If this situation arises, then the 50/50 MVAR load will need to be adjusted upwards to account for the reduction of the 90/10 MW load to the 50/50 MW load at the same power factor as the 50/50 load instead of at the higher power factor of the 90/10 load, i.e., DR is assumed to have the same power factor as the 50/50 load.

C.2.3.2 Dispatch for Load Deliverability Study Area

Two separate power flow cases are created for each LDA. The Mean Dispatch case models the average value of each generator's output for the LDA under study from over 10,000 unique dispatches at the CETO. The Discrete Outage case models the most likely discrete generator outage pattern within the LDA at the CETO. As described in the CETL determination section, thermal and voltage analysis is performed on both of these power flow cases.

C.2.3.2.1 Dispatch Procedure for Mean Dispatch Case

1. All generators in the study area are sampled until 10,000 generation outage scenarios are found where the amount of generation selected is within +/- 2% of the amount needed to meet the target generator outage value required to model the import objective.
2. The 10,000 generation outage scenarios are determined by using a Monte Carlo simulation and assigning a random value between 1 and 0 to each generator in the study area. If the random value is greater than the generator forced outage rate, then that generator is turned on at its full capability. If the value is less than the generator forced outage rate, then that generator is turned off. There is no limit to the number of units that can be simultaneously outaged at a station.

3. Determine the average MW output of each generator in the study area by using its dispatched values in the 10,000 generator outage scenarios.
4. The reactive capability of each unit is reduced by the ratio of each unit's average MW output from the preceding step to the unit's maximum MW output.
5. Create a base case modeling the average MW output and reactive capability of each generator determined using the above steps.

C.2.3.2.2 Dispatch Procedure for Discrete Outage Case

1. Derate all generators in the zone by their EFORd.
2. Rank generators by $EFORd^{(1/PMAX)}$.
3. To model discrete generator outages, select generators in rank order until the next selected generator would exceed 105% of the target generator outage value at the CETO.
 - a. LDA target generator outage value = LDA UCAP – LDA target generation
 - b. LDA UCAP = $\text{Sum } (1-EFORd)*PMAX$ for each LDA generator
 - c. LDA target generation = LDA load – LDA CETO
4. Multiple generators at the same substation may be taken off line unless the outaged MW to installed MW ratio is greater than 60%. (For example, if a station had 3-100 MW units, 1 unit would be outaged since $100 \text{ MW}/300 \text{ MW} = 33\%$ but two units would not be outaged since $200 \text{ MW}/300 \text{ MW} = 66\%$)
5. Any remaining MW outages required to meet the target generator outage value will be obtained through a uniform scale of all on-line generation's MWs and MVARs in the study area.
6. The Transmission Owner(s) may request analysis of a different outage pattern. If this outage pattern results in more severe reliability problems it will be used in place of the original outage pattern only if both the Transmission Owner and PJM accept the new outage pattern.

C.2.3.3 Dispatch for PJM Areas not in a Capacity Emergency

As part of the starting dispatch for PJM Areas not in a Capacity Emergency PJM generators should be dispatched per existing RTEP base case procedures (see also "Deliverability of Generation").

C.2.3.4 Dispatch for non-PJM Areas not in a Capacity Emergency

One of the base principles for the load deliverability test is that the study area is the only area that is in a capacity emergency. All adjacent external areas to PJM are assumed to be at a peak load but in a non-emergency condition. The PJM firm interchange shall not be adjusted as part of the load deliverability test.

No dispatch or other adjustments will be made to the non-PJM areas to support the PJM area experiencing the capacity emergency.

C.2.4 Capacity Emergency Transfer Objective (CETO) Procedure

The Capacity Emergency Transfer Objective (CETO) analysis determines a target MW import value for an LDA that ensures sufficient transmission capability exists to access available PJM capacity reserves located outside the LDA. The import value determined is a measure of the transmission capability required by the LDA so that the study area does not experience a planned, transmission-induced loss of load event more frequently, on average, than 1 time in 25 years.

The CETO for each LDA in PJM is determined using PJM's reliability software to perform a single area reliability study for each LDA. The system models are based on the latest RTEP load and capacity data available at the time of the study. Only the load and capacity within the study area are modeled while the capacity supply from outside the study area is assumed to be unlimited. The transmission system is not modeled. The CETO is the import capability value that is necessary for the study area to achieve the CETO reliability standard. The CETO reliability standard requires no more than one loss of load event per LDA in 25 years.

More detail about the CETO is available in PJM Manual 20 – Resource Adequacy Analysis at <http://www.pjm.com/library/manuals.aspx>

C.2.5 Capacity Emergency Transfer Limit (CETL) Procedure

The goal of a PJM Load Deliverability study is to establish the amount of emergency power, or CETL, that can be reliably transferred to the study area from the remainder of PJM in the event of a generation deficiency within the study area. This transfer limit, in combination with its corresponding CETO, is then used to determine if the import capability required in order to meet the reliability objective of a 1/25 LOLE is sufficient. An indicator of the amount of reserve transfer capacity available is provided by the difference between the CETL and CETO.

C.2.5.1 Procedure for Determining Load Deliverability Facility List

The following procedures outline the process for determining which facilities will be monitored for the PJM Load Deliverability test. The first procedure provides the details for internal PJM facilities and the second procedure concentrates on external PJM facilities.

C.2.5.1.1 Internal PJM Load Deliverability Facility List

- PJM monitors all internal transmission facilities for its load deliverability test and screens criteria violations for upgrades that pass an outage transfer distribution factor (OTDF) cutoff test and are on PJM's monitored facility list (lists of PJM monitored lines and substations are available at <http://www.pjm.com/markets-and-operations/ops-analysis/transmission-facilities.aspx>.) The resulting list of facilities constitutes the PJM Load Deliverability Facility List and may vary from study to study because changes in system topology may change the OTDF.
- PJM ensures load deliverability for its entire region by individually studying each LDA. A different subset of the Transmission Facilities is therefore the primary focus for each study area. PJM Transmission Facilities that are not included in the Load Deliverability Facility List are still considered in the load deliverability test. However, they will not be considered as limiting Transmission Facilities for imports into an LDA unless there is also one or more Load Deliverability Facilities simultaneously limiting imports into the

LDA, or unless both PJM and the Transmission Owner agree that the facility should be included in the Load Deliverability Facility List regardless of the OTDF.

- The following list of rules defines the OTDF (TDF for pre-contingency violations) cutoff for PJM facilities that will be included in the separate Load Deliverability Facility List for each study area. A TDF is the MW flow over a facility that results from a MW transfer from a source point of all PJM generation external to the study area and a sink point of all load internal to the study area. An OTDF is the TDF after a transmission outage has occurred on the system. Note that if a 100 kV and up facility has a OTDF that is below the OTDF cutoff for each LDA, then that facility will either be addressed in the generator deliverability test or become subject to reliability screening under the standard NERC TPL 001-4 criteria³.
 - o All non-radial facilities with a low side voltage 345 kV or greater will be included if their OTDF is greater than or equal to 5%.
 - o All non-radial facilities with a low side voltage 345 kV or greater will be included if their OTDF is greater than 2% and less than 5% unless both PJM and the TO agree that the facility should not be included.
 - o All non-radial facilities with a low side voltage 345 kV or greater will be not included if their OTDF is less than 2% unless both PJM and the TO agree that the facility should be included.
 - o All non-radial facilities with a low side below 345 kV with an OTDF greater than 10% will be included.
 - o All non-radial facilities with a low side below 345 kV with an OTDF between 5% and 10% will be included unless both PJM and the TO agree that the facility should not be included.
 - o All non-radial facilities with a low side below 345 kV with an OTDF less than 5% will not be included unless both PJM and TO agree that the facility should be included.
- All PJM monitored facilities will be included when determining any generation redispatch or PAR movements required for the base case development. However, only the facilities on the Load Deliverability Facility List will require a system upgrade if overloaded for this load deliverability test.
- The substations to be included for voltage analysis will be developed based on the Load Deliverability Facility List. In other words, the OTDF for a substation will be determined based on the highest OTDF of the transmission facilities directly connected to the substation under the contingency conditions that result in voltage issues. Additional substations will be included for voltage analysis if agreed to by PJM and the TO.

³ Any 100 kV and above facility that is not subject to upgrade screening in the load deliverability analysis will be evaluated in a subsequent screening that evaluates the NERC TPL-001-4 criteria in the 50/50 peak load scenario. All facilities failing these standard NERC criteria will be identified for upgrade requirements.

C.2.5.1.2 External PJM Load Deliverability Facility List

For transmission facilities outside of but electrically close to PJM, PJM conducts joint coordinated interregional studies on a periodic basis that examine and address deliverability issues between PJM and adjacent external systems. Based on the results of these joint studies, PJM may choose to include specific non-PJM transmission facilities in the load deliverability test in order to account for significant loop flows that occur through non-PJM transmission systems when large transfers within PJM are present. In order for a non-PJM transmission facility to be included as an External Load Deliverability Facility in either the thermal or voltage load deliverability analysis, it must meet same OTDF cutoff rules that are required for Internal Load Deliverability Facilities.

C.2.5.2 CETL Determination

The CETL for the LDA under study will be the lower of the CETLs identified during the load deliverability studies for thermal and voltage constraints.

C.2.5.2.1 CETL for Thermal Problems

1. Perform an AC contingency thermal analysis on both the Mean Dispatch Case and the Discrete Outage Case to obtain the percent loading on each flowgate for each case at the CETO.
2. If any overloads exist, any of the system adjustments noted in section C.2.1.3.2 can be implemented.
3. Any overloads that still remain will require mitigation in order for the study area CETL to exceed the CETO.
4. If no overloads remain at the CETO import level, then additional transfers into the LDA will be simulated and system adjustments will be applied as necessary. This procedure will be repeated until a transfer level is found (CETL) where one or more transmission facilities on the PJM Load Deliverability Facility list for the LDA under study reaches its applicable thermal limit.
5. The thermal CETL will be the lower of the CETLs determined from the Mean Dispatch and the Discrete Outage Cases

C.2.5.2.2 CETL for Voltage Problems

1. Perform an AC contingency voltage analysis on both the Mean Dispatch Case and the Discrete Outage Case after system adjustments have been implemented to resolve any thermal overloads. Redispatch procedures may be considered to alleviate voltage issues.
2. Any voltage issue that appears at the CETO will require mitigation in order for the study area CETL to exceed the CETO.
3. If no voltage issues exist at the CETO import level, then additional transfers into the LDA will be simulated and system adjustments will be applied as necessary. This procedure will be repeated until a transfer level is found (CETL) where one or more substations on the PJM Load Deliverability Facility list for the LDA under study reaches its applicable voltage limit.

4. The voltage CETL will be the lower of the CETLs determined from the Mean Dispatch and the Discrete Outage Cases.

C.2.6 CETO/CETL as an Input to RPM

PJM follows a similar procedure for the CETO/CETL analysis used as an input to the RPM Base Residual Auction (BRA). This analysis is based on the CETO/CETL analysis used in the RTEP Load Deliverability procedure, but focuses on a 3 year out case. Units without a final GIA or ISA that have cleared in a prior BRA are also included.

In addition to the CETO/CETL analysis performed as an input to the RPM BRA, PJM also determines if there are any easily resolved constraints that could improve the ratio between the CETL and the CETO beyond the threshold of 115%. The process for determining the inclusion of an easily resolved constraint as a transmission upgrade in the RTEP is documented in the PJM OATT (Tariff) in Section 15 of Attachment DD. Criteria needed to be met to include an easily resolved constraint as a transmission upgrade in the RTEP include

- The transmission upgrade(s) will result in a Capacity Emergency Transfer Limit that exceeds 1.15 times the Capacity Emergency Transfer Objective for the LDA; and
- The transmission upgrade(s) is/are expected to be in-service prior to June 1 of the Delivery Year for which the Base Residual Auction is being conducted; and
- The transmission upgrade cost is expected to be less than \$5 million; and
- There are no Merchant Network Upgrades that have or are expected to have met all Decision Point II requirements by 45 days prior to the Base Residual Auction that are designed to resolve the same constraint for which the RTEP upgrade is designed to resolve.

The annual costs of such upgrade shall be allocated as specified in Schedule 12 of the tariff.

C.3 Deliverability of Generation

The second deliverability test examines the ability of an electrical area to export Capacity Resources to the remainder of PJM. This test is applied to ensure that capacity is not "bottled" from a reliability perspective. This requires that each electrical area be able to export its capacity, at a minimum, during the summer peak load period as this represents the condition where PJM reserve margins have historically been at their lowest levels. But just demonstrating deliverability in the summer period is not sufficient to ensure operational performance and flexibility is maintained during other part of the year. PJM examines export capabilities under winter and light load conditions as well. All three generator deliverability tests are required to be passed in order for a generator to become certified as a PJM Capacity Resource. Deliverability, from the perspective of individual generator resources, ensures that, under normal system conditions, if Capacity Resources are available and called on, their ability to provide energy to the system will not be limited by the dispatch of other certified Capacity Resources. This test does not guarantee that a given resource will be chosen to produce energy at any given system load condition. Rather, its purpose is to demonstrate that the installed capacity in any electrical area can be run simultaneously, and that the excess energy above load in that electrical area can be exported to the remainder of PJM, subject to the same single contingency testing used

when examining deliverability from the load perspective. In addition, common mode outages are examined as part of the generator deliverability test. In short, the test attempts to ensure that bottlenecked capacity conditions that limit the availability and usefulness of certified Capacity Resources to system operators will not exist. In actual operating conditions, energy-only resources may displace Capacity Resources in the economic dispatch that serves load.

This test demonstrates that Capacity Resources in any given electrical area could simultaneously deliver energy to the remainder of PJM. The premise of the generator deliverability test is that all PJM Capacity Resources within an electrical region within PJM are required; hence the remainder of the system outside this electrical region is experiencing a significant reduction in available capacity. The dispatch pattern in the remainder of the system is uniformly reduced according to the relative amounts of online generation at each location.

C.3.1 Generator Deliverability Procedure

C.3.1.1 Introduction

To maintain reliability in a competitive capacity market, resources must contribute to the deliverability within the PJM Control Area in two ways. First, energy must be deliverable, from the aggregate of resources available to the PJM Control Area to load in portions of the applicable PJM areas experiencing a localized capacity emergency. PJM utilizes the Load Deliverability procedure to ensure this requirement. Second, Capacity Resources within a given electrical area must, in aggregate, be able to be exported to other areas of PJM when required. PJM utilizes the Generator Deliverability procedure to ensure the deliverability of individual generation resources. The following sections describe the Generator Deliverability procedure.

C.3.1.2 Study Objectives

The goal of the PJM Generator Deliverability study is to determine if the aggregate of generators in a given area can be reliably transferred to the remainder of PJM. Any generators requesting interconnection to PJM must be deliverable in order to be a PJM installed Capacity Resource. Addendum 1 to this section describes procedure for modeling Merchant Transmission Facilities in the generator deliverability test. Addendum 2 to this section describes procedures for examining deliverability of any single generating plant up to its maximum facility output and any single Merchant Transmission Facility at its full capability. Addendum 3 to this section describe procedures for evaluating Long Term Firm Transmission Services Requests. Addendum 4 to this section describes gas pipeline contingencies examine as part of the winter test.

C.3.1.3 General Procedures and Assumptions

Step 1: Develop Base Case

The RTEP base case is developed for a reference year 5 years in the future. All identified RTEP Baseline and Supplemental Projects projected to be in service by

- April 15 of the reference year are including in the system model for the Light Load RTEP Base case

- June 1 of the reference year are including in the system model for the Summer RTEP Base case
- December 1 of the reference year are including in the system model for the Winter RTEP Base case

Load is modeled at a non-diversified forecasted 50/50 load level for the period being examined.

- Light Load Period: Those hours between 10AM and 3PM where the PJM coincident peak load is between 40-60% of the annual peak. In the Light Load base case, load levels are modelled at 50% of each area's non-coincident summer peak forecast.
- Summer Period: June through August hours 2PM-6PM
- Winter Period: December through February hours 5AM-9AM and 6PM-10PM

In coordination with individual TOs, PJM will select and apply a Transmission Facility temperature degree ratings set as appropriate. PJM will apply the ratings set on an individual TO basis. The default temperature degree ratings sets are

- Light Load: 59 °F
- Summer: 95 °F
- Winter: 50 °F, 41 °F or 32 °F

All long-term firm transmission service confirmed for the reference year and service with rollover rights that has been coordinated with the applicable PJM neighboring region is included in the model. Generation and Merchant Transmission Facilities that have proceeded at least through the execution of the final agreement stage of the interconnection process are considered in the model along with any associated network upgrades. If existing Capacity Resources and those with an executed final agreement are not sufficient to meet overall system demand levels then Capacity Resources that have met all Decision Point II requirements may be considered as well.

The starting point dispatch is developed as explained in the next step. PJM uses a block dispatch approach to dispatch the generation and limits the maximum output of any single generator to account for the PJM system-wide forced outage rate and regional weather-related unavailability. This approach to dispatching the generation attempts to broadly account for the economics and operating limitations of individual resource types during the period under examination and avoids direct consideration of any particular resource's confidential economic and operating limitations and the significant bias a less generic dispatch pattern can have on the final overload results.

Step 2: Establish initial RTEP dispatch for unit under study

PJM uses a block dispatch coupled with system wide outage and regional weather considerations to dispatch generation. As shown in Table 1 below, the block dispatch procedure starts with the required generation target to satisfy system wide demand (load, losses and firm interchange) and sequentially dispatches existing units and those with a final agreement in blocks 1, 2 and 3 as needed. If a particular block is only partially needed to meet

system demand, then the resources in this block are dispatched as necessary to act as the slack generation and provide constraint control, i.e. certain generators may be dispatched online to relieve base case overloads. Capacity factors used during the block dispatch will be updated and published annually as part of the RTEP assumptions.

In order to ensure that the dispatch does not result in a capacity emergency condition in any of the PJM areas, further redispatch within the area may need to be performed to ensure the area is not importing more than its Capacity Emergency Transfer Objective (CETO). The redispatch methodology will follow the block dispatch approach described above and ensure that the online generation in each area is no less than

- Minimum area generation = $(\text{Load} + \text{losses} - \text{CETO}) / (1 - \text{PJM Avg EEFORd})$

The denominator in the above equation adds a small margin to the CETO in order to account for the generation ramping that will occur during the actual generator deliverability test. This approach avoids the need to consider the CETO directly in the test itself and helps provide a reasonable starting dispatch for each area. In order to set the minimum area generation, the last block of generation in each area is dispatched to ensure a simultaneous dispatch across PJM where no area is exceeding its CETO plus a small margin and the overall system demand is satisfied. This represents the starting dispatch in the RTEP baseline generator deliverability studies.

Table 1 – Block Dispatch for RTEP Base Cases

Block	Resource Type	Initial Dispatch
1	Nuclear	$\text{P}_{\text{MAX}} * (1 - \text{PJM Avg EEFORd})$
	Wind	Capacity Factor
	Solar	Capacity Factor
	Pumped Hydro	$\text{P}_{\text{MIN}} * (1 - \text{PJM Avg EEFORd})$ LL; $\text{P}_{\text{MAX}} * (1 - \text{PJM Avg EEFORd})$ Winter & Summer
	Non-Pumped Hydro	$\text{P}_{\text{MAX}} * (1 - \text{PJM Avg EEFORd})$
	Other Renewable	$\text{P}_{\text{MAX}} * (1 - \text{PJM Avg EEFORd})$
2	Coal	$\text{P}_{\text{MAX}} * (1 - \text{PJM Avg EEFORd})$
	Combined Cycle	$\text{P}_{\text{MAX}} * (1 - \text{PJM Avg EEFORd})$
3	Simple Cycle	$\text{P}_{\text{MAX}} * (1 - \text{PJM Avg EEFORd})$

Note 1: PMAX represents the unit's maximum output for the period. Note 2: Capacity Factor represents the average output for the period. Note 3: In summer, PMAX is replaced with the lower of the Capacity Factor or Capacity Interconnection Rights (CIRs). Note 4: Batteries will be modeled offline but available to be ramped.

During the generator deliverability evaluation of a New Service Request, additional dispatch procedures are employed. More specifically, all resource requests in the study queue ahead of the unit under study are set at 0 MW but available to be turned on. The resource request under study is also set at 0 MW but available to be turned on. Resource requests queued after the unit under study are not modeled.

Step 3: Determine potential overloads

PJM uses a linear (DC) power flow program to analyze each facility for which PJM is responsible to determine whether any single or common mode contingency can overload the facility. These results are utilized to determine which flowgates will be used in the generator deliverability analysis, i.e., the program examines each PJM flowgate (contingency / monitored element pair) in the entire PJM footprint as well flowgates near the border of PJM. The procedure below explains conceptually how the program works; following the procedure below would yield the same results as the program. The procedure uses a load flow set up according to step 2.

Determine the distribution factor for each generator on each flowgate. The distribution factor for a particular generator is referenced to the PJM online generation. For each flowgate, group the Generation Capacity Resources based on whether the distribution factor is positive, in which case increases in the generator's output contribute to the loading on the flowgate and the generator is considered a "Harmer", or negative, in which case increases in the generator's output reduce the loading on the flowgate and the generator is considered a "Helper". Note that the light load test considers pumped storage units in the pumping mode and batteries in both the discharging and charging mode and the appropriate mode to ramp will be based on whether the distribution factor is positive for that mode. For generators with a positive distribution factor on the flowgate, multiply the distribution factor of each generator by the offline portion of the generator to obtain the MW impact the generator would have on a particular flowgate if it were ramped from its output in the initial load flow to its full output. For wind and solar generators with a negative distribution factor on the flowgate, multiply the distribution factor by the online output of the resources to obtain the MW impact the generator would have if it were turned off. This latter step will account for the high variability of the output levels of wind and solar units and the fact that a stressed dispatch should consider lower than average outputs from these resource types. The summation of these MW impacts on the flowgate is the cumulative ramping impact.

For all flowgates determine the cumulative ramping impact of generators with greater than a 1% distribution factor. The total amount of ramped generation as part of this initial identification of potential overloads is capped to limit the number of potential overloads to a reasonable number of the worst impacts. A typical cap for the total ramping of internal generation is 10,000 MW (20,000 MW for studies examining the impacts of external generators as well) but the actual value can vary to establish a reasonable scope for the potential overloads. For each flowgate, add the cumulative ramping impact to the initial DC loading. If the resulting DC loading is greater than the flowgate rating, then this flowgate is a potential overload.

Step 4: Determine Wind and Solar and 50/50 Harmer impacts

The number of generators having greater than a 1% distribution factor in Step 3 is often large enough that having them all simultaneously outputting their full installed capacity or simultaneously be offline in the case of wind and solar would be extremely improbable. As a result, in this step the number of generators contributing to the cumulative ramping impact on a flowgate is further restricted in the following manner.

Dispatch blocks 1 through 3 are available for ramping in the summer and winter testing and wind and solar resources are available for ramping in the light load test. In addition, batteries in the discharging mode will be considered in light load, summer and winter generator deliverability testing. Also, during the light load condition pumped storage in the pumping mode and batteries in the charging mode will also be considered.

The ramping limit for wind and solar units are applied. For summer, single contingency testing conditions, the ramping level for wind and solar units with a positive distribution factor is restricted to its Capacity Interconnection Rights (CIR). For winter, single contingency testing conditions and summer and winter, common mode outage testing conditions, wind and solar units with a positive distribution factor are restricted to the following regional ramping levels.

- Onshore Wind: P90%
- Offshore Wind: P80%
- Fixed Solar: P80%
- Tracking Solar: P80%

For light load, single contingency and common mode outage testing conditions, wind and solar units with a positive distribution factor are restricted to the following regional ramping levels.

- Onshore Wind: P90%
- Offshore Wind: P80%
- Fixed Solar: Light Load Capacity Factor
- Tracking Solar: Light Load Capacity Factor

These percentiles are used to define the output level for the resource type in the region in which it is located as a percent of its maximum facility output for the period under study below which the specified percentage of output levels would occur, e.g. the P90% for onshore wind units in the Mid-Atlantic Region over the summer period is 38% of the MFO.

For example, onshore wind units will be ramped to a level that is unlikely to be exceeded more than 10% of the time on a wide-area basis. The output levels are based on 10 years of historical or backcast data and are determined by resource type and PJM region (MAAC, PJM West, Dominion) by using the capacity-weighted output level for each area where the resource type is located within the region. The output levels associated with these percentiles will be updated and published annually.

Generation Capacity Resources modeled in the power flow with greater than a 5% distribution factor (or 10% distribution factor for flowgates whose monitored element's lowest terminal voltage level is equal to or greater than 500 kV) that contribute to the cumulative ramping impact are ranked according to their distribution factor on a potentially overloaded flowgate. These are called "Harmer" generators.

Wind and solar units are not assigned an EEFORd because their output levels are based on historical data that inherently accounts for forced outages. For each flowgate, all wind and solar Harmer unit outputs are increased to their ramping levels defined above. The multiplication of the resulting MW output for each wind and solar resource by its DFAX on the flowgate is the wind and solar Harmer impact.

For Generation Resources other than wind and solar resources, the availability ($1 - \text{EEFORd}$) of the unit with the highest distribution factor is then multiplied by the availability of the unit with the second highest distribution factor and so on until the expected availability of the selected units is as close to but not less than 50%. Also, generating plants whose maximum output level is less than 50 MW will not be assigned an EEFORd to help ensure that the impacts of larger units are not masked during this process. This resulting "50/50" cumulative ramping impact is then added to the initial DC loading on the flowgate from the base case dispatch under the specified contingency condition. This resulting loading is the 50/50 DC loading and the generators chosen to contribute to the cumulative ramping impact are the 50/50 generators.

All default ramping limits and Capacity Factors used in the generator deliverability test for all study periods will be updated and published annually.

Step 5: Determine other flowgate impacts

This Step 5 addresses contributions to a flowgate loading beyond those created by the 50/50 dispatch.

- Step 5a addresses offline generators that have a positive distribution factor on the flowgate.
Step 5b addresses online wind and solar generators that have a negative distribution factor on the flowgate.
- Step 5c addresses interchange considerations.
- Step 5d addresses non-PJM ramping considerations.

Step 5a: Determine Facility Loading Adder

Existing generators which have submitted a request to deactivate, active queued generators and merchant transmission projects that do not yet have a signed final agreement or have a suspended final agreement may be modeled offline, and, if so, are available to be turned on to contribute to but not back off flowgate loadings. The ramping impact of this set of generators determines the Facility Loading Adder. Facility Loading Adders do not consider offline wind and solar units which are handled separately in Step 4. Further, they are only applied in the summer generator deliverability test where the offline resources will likely be required.

First, for their ramping impact to be considered, off-line generators must pass the impact threshold of at least a 5% DFAX (10% for flowgates with monitored elements having the lowest

terminal voltage 500 kV and above) on a flowgate or with an impact (DFAX times a generator's full energy output rating) greater than 5% of the flowgate's rating.

All studies in Phase I, II, and III will use 100% commercial probability.

The ramping impact of active queued generators at the Phase I System Impact Study stage of the interconnection process considers the commercial probability. For generators at the Phase I System Impact Study stage of the interconnection process, the output of the generator is multiplied by the historic commercial probability of a generator at the Phase II System Impact Study stage of the interconnection process. To be conservative, the values developed during the Phase I System Impact Study stage are then multiplied by 150% to determine the ramping impact of generation at the Phase I System Impact Study stage of the interconnection process.

Step 5b: Account For Lower Than Expected Wind and Solar Outputs

Online wind and solar units with a negative distribution factor are assigned the following lower ramping levels, which are derived in a similar manner to the percentiles developed for wind and solar in Step 4.

- Onshore Wind: P20%
- Offshore Wind: P20%
- Fixed Solar: P20%
- Tracking Solar: P20%

The output levels associated with these percentiles will be updated and published annually.

Step 5c: Interchange Considerations

In order to account for generation assistance from outside PJM in the summer and winter generator deliverability test each receiving end area will be assigned a portion of the PJM Capacity Benefit Margin (CBM) based on the receiving end areas' share of the PJM load. CBM is the amount of import that PJM assumes will be available from neighboring regions during a RTO-wide capacity deficiency.

In the winter and summer generator deliverability test, average historical utilization of PJM firm transmission service is considered to ensure that a range of actual firm usage can be supported. The test examines whether the system can support any combination of firm transmission service between the average historical level up to the full reserved amount.

In the light load generator deliverability test, the average historical interchange levels achieved for this period between PJM and the five external regions defined in the PJM Capacity Import Limit study (see Attachment G.11) and controllable Merchant Transmission Facilities will be examined in addition to the full amount of reserved transmission service.

Step 5d: Account For Non-PJM Ramping Considerations

Under heavy penetration of intermittent resources, it is expected that system dispatches will become more volatile. PJM will incorporate into its generator deliverability test non-PJM dispatch considerations that have resulted in or are expected to result in operational performance issues which hinder the ability of PJM Capacity Resources to deliver their output.

At present, there is a growing penetration of onshore wind in the MISO region that occasionally results in such operational performance concerns on the PJM system. These concerns occur outside of the summer period. As a result, PJM includes ramping of the MISO wind in both the light load and winter generator deliverability testing. The ramping level is the same as that used for onshore wind in the PJM West region in PJM. The sink for the MISO onshore wind ramping is the Northern part of the MISO system.

PJM will periodically assess the need to incorporate other non-PJM dispatch considerations into the generator deliverability test to ensure impacts to the ability of PJM Capacity Resources to deliver their output are appropriately accounted for.

Step 6: Determine Final Flowgate Loading

- The total amount of 50/50 and Facility Loading Adder generation shall not be any more than the online generation \times PJM average EEFord. This rule is enforced by curtailing generators that contribute to both the 50/50 list and the Facility Loading Adder. Similarly, the amount of wind and solar generation increased in step 4 to account for higher than expected outputs as well as the amount of wind and solar reduced in Step 5b to account for lower than expected outputs will capped at the same level.

If a flowgate has a final DC loading less than 90% of its rating, it is not considered to be overloaded and is not tested further. If a flowgate has a final DC loading greater than or equal to 90% of its rating, the 50/50 generators are ramped up to their installed capacity in the load flow from step 2 and all remaining PJM generators are uniformly ramped down such that the PJM firm interchange is maintained. The resulting flowgate loading is the 50/50 AC loading.

The Facility Loading Adder can sometimes have a significant impact on the results of a deliverability study. However, ramping up the units associated with the adder in the load flow will sometimes create a localized capacity emergency condition elsewhere when the rest of PJM is proportionally displaced to maintain the firm interchange. Therefore, to account for the effect of these units on the facility in question, the Facility Loading Adder, which is a DC value as determined in Step 5, is added to the 50/50 AC loading to result in the Final Flowgate Loading.

Addendum 1: Modeling Merchant Transmission Facilities (MTFs)

Controllable MTFs, i.e. HVDC which interconnects PJM to another system, may have some combination of firm rights (Transmission Withdrawal Rights, Transmission Injection Rights or long-term firm transmission service). Existing MTFs with firm rights and MTFs with an executed ISA or GIA with firm rights are modeled as a transmission facility carrying the firm rights. Refer to Exhibit 3.

In the case of a bi-directional MTF, the rights associated with the injection into PJM are modeled as an offline generator at the PJM MTF terminal. A net injection from the terminal into PJM equal to the firm injection rights is simulated, consistent with the 50/50 and Facility Loading Adder rules, when such injection contributes to a flowgate's loading.

If the MTF request does not have an executed ISA or GIA it will be modeled offline but be allowed to contribute to flowgate loadings consistent with the 50/50 and Facility Loading Adder rules.

Scenario	LTF TS?	Firm TWRs?
1	No	No
2	No	Yes
3	Yes	No
4	Yes	Yes

*LTF TS = Long-term Firm Transmission Service; Firm TWRs = Firm Transmission Withdrawal Rights

Load & Generator Deliverability

- Scenario 1 not considered
- Scenarios 2, 3 & 4 modeled at greater of LTF TS or Firm TWRs
- Firm TIRs modeled as offline generator at MTF PJM terminal in generator deliverability test and able to contribute to but not back off loadings

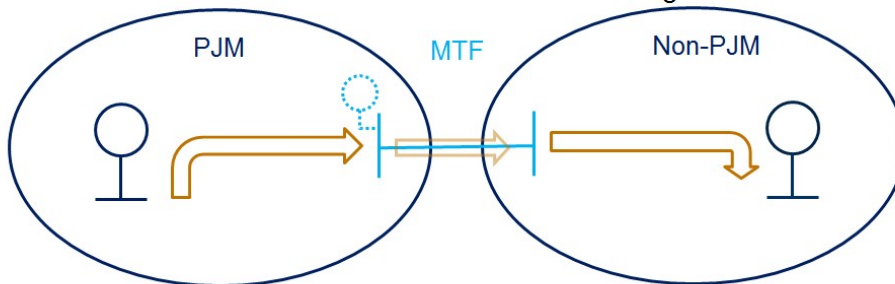

*Arrows represent firm flows

Common Mode Outage Deliverability

- Scenarios 1 through 4 modeled at FTWRs + NFTWRs
- FTIRs + NFTIRs modeled as offline generator at MTF PJM terminal able to contribute to but not back off loadings

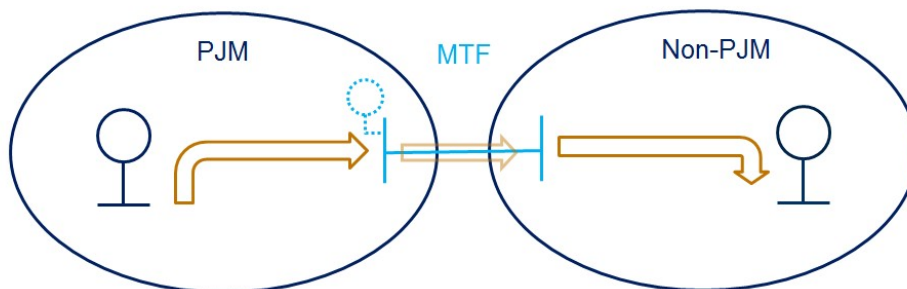

*Arrows represent firm + non-firm flows

Exhibit 3: Modeling Rights for Merchant Transmission Facilities

Addendum 2: Individual Plant Deliverability Procedure

PJM planning criteria requires that each individual generating plant can be ramped up to its seasonal maximum facility output and each controllable Merchant Transmission Facility can be ramped up to its maximum capability in each direction that it is capable of operating. Under these conditions, the system must be secure for single and common mode contingencies.

Addendum 3: Transmission Service Study Procedures

During the conduct of New Service Request studies, for the evaluation of Transmission Service impacts during generator deliverability testing and common mode outage testing, contribution thresholds have been developed to account for the proximity of the source of the service in relation to the PJM footprint. During testing of transmission service seeking to import energy into PJM, PJM shall use a 3% distribution factor or 3% rating cutoff to select the service which shall be allowed to contribute to flowgates under study. During testing of transmission service seeking to export energy from PJM, PJM shall use these same distribution factor and rating cutoffs to select the service which shall be allowed to contribute to flowgates under study when that flowgate involves a facility outside of PJM's footprint; however, PJM shall maintain all thresholds for impacts to flowgates that involve PJM facilities consistent with the requirements listed outside this Addendum 3.

In both baseline and New Service Request studies, constraints identified in the PJM Capacity Import Limit procedure (Section G.11 PJM Capacity Import Limit Calculation Procedure) are studied in the same manner as internal PJM constraints. With regard to transmission service, in baseline studies any transmission service which impacts a constraint identified in the CIL study shall have the full impact of the service added to the loading of the applicable facility in determining the final facility loading. In New Service Request studies any transmission service which impacts a constraint identified in the CIL study at greater than the thresholds identified above in this section shall have the full impact of the service added to the loading of the applicable facility in determining the final facility loading.

In both baseline and New Service Request studies, existing import and export reservations which back off overloads will be ramped down to a percentage consistent with the peak historical usage in order to reduce the counter flow for confirmed service to expected levels.

In both baseline and New Service Request studies, PJM shall preserve the Capacity Benefit Margin (CBM) by ensuring that the full amount, specified in the PJM Reliability Assurance Agreement Schedule 4.D, can be imported in addition to the net firm interchange. The distribution of the CBM from each of the five external supply zones shall be determined during the annual PJM Capacity Import Limit (CIL) study, and the CBM impacts will only be considered when they contribute to the loading on a constraint.

Addendum 4: Gas Pipeline Contingencies

PJM will maintain and apply a gas pipeline contingency analysis in winter studies. The gas pipeline contingency set will include gas pipeline contingencies due to the failure of a gas pipeline or a compressor station. The gas pipeline contingency list will be reviewed periodically to validate its accuracy. In addition to the gas pipeline contingencies, gas temperature threshold contingencies will be evaluated. At a pre-determined temperature threshold, assume that non-firm customers (i.e. non-heating demand and 100% of natural gas generation customers in that zone) will be interrupted.

C.4 Long-Term Deliverability Analysis

The purpose of the long-term deliverability analysis is to identify any reliability violations on the PJM system that may require an upgrade that requires more than a 5 year lead time to implement. As part of the PJM RTEP long-term reliability review process, generator and load deliverability analysis for years 6 through 15 are examined. The long-term deliverability analysis starts with the deliverability results from the near-term base case and, together with the results from the long-term reliability analysis, interpolates the thermal results to obtain the loadings for each year in the long-term planning horizon. The long-term base case is developed from the near-term base case each planning cycle and includes generation additions as necessary to support forecast load growth and replace deactivations.

C.4.1 Base Case Development

PJM has a 36-month reliability planning cycle. At the end of the first year of the cycle, a near-term 5-year out base case, a long-term 8-year out base case and a long-term 15-year out base case are developed. At the latter part of the second and third years of the cycle, a new 5-year out base case and a long-term 8-year out base case are developed.

Assumptions used in the development of these base cases are reviewed in the PJM stakeholder process. The same general rules of construction described in section C.3.1.3 of this Manual that are used to create the near-term base case are used to create the long-term base case. However, because the assumptions used in the long-term planning models rely on forecast system conditions that are less certain than those used in the near-term planning models, a much broader and more sophisticated set of planning assumptions need to be developed in order to construct long-term planning models.

In addition, the considerations of scenarios plays a much more important role in the long-term timeframe than in the near-term timeframe. To support the long-term timeframe, PJM will construct a base reliability scenario and associated base cases ~~consisting of a minimum set of inputs that must be modeled to ensure resource adequacy~~ and identify future transmission needs and solutions required to maintain the reliability of the system. This scenario is called the base reliability scenario. The primary inputs into the base reliability scenario are the PJM Load Forecast Report; existing generation not anticipated to deactivate as described further in this section; replacement generation from the PJM New Service Request process to ensure resource adequacy. Additional replacement generation, if needed, beyond the PJM New Service Request process will be selected as necessary to ensure resource adequacy. To determine the specific replacement generation from the New Service Request process and beyond that may be necessary to ensure resource adequacy, PJM will use widely accepted capacity expansion modeling tools that will be reviewed with stakeholders upfront and refined periodically as necessary to improve the models' performance.

In order for an anticipated deactivation to be accounted for in the base reliability scenario it must fall into one or more of the following three categories:

1. Official deactivation announcements received by PJM
2. Public Policy Requirements

3. Company ESG (Environmental, Social, Governance) commitments brought to the attention of PJM. Such commitments must be per legal consent decree or other public statement such as a press release, financial plan or Integrated Resource Plan (IRP).

PJM will work with stakeholders to determine whether additional scenarios and/or sensitivities, for example regarding load, retirements and additions to the base reliability scenario may be useful to help inform the posting of the reliability needs and the selection of transmission solutions that result from the base reliability scenario. In parallel, PJM will also work with stakeholders to develop a public policy scenario to support states in identifying and selecting public policy projects as defined in the Operating Agreement, Schedule 6, section 1.5.9, which may be also be used to inform decisions regarding enhancements or expansions to the system made in regards to the base reliability scenario, through either modifications of the in-service date of required transmission projects or identification of Multi-Drive Projects, and in accordance with the Operating Agreement, Schedule 6, section 1.5.1(a). As a result, the first phase of the long-term planning cycle is devoted to working closely with the ISAC and TEAC to define the parameters that will be used in the development of these long-term planning assumptions to be used in the base reliability scenario and in any scenario and sensitivity models. PJM shall make the final determination as to which scenarios and sensitivities are considered as well as the assumptions that are included in each scenario or study to be completed.

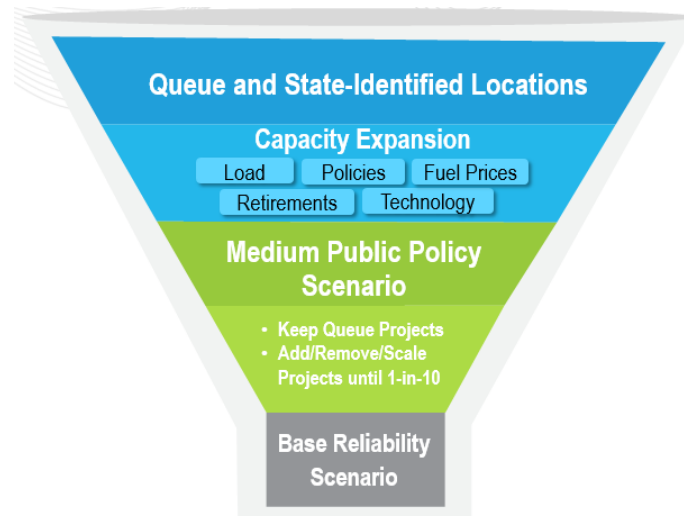

Base Reliability Scenario Primary Inputs	
Load	PJM Load Forecast Report
Retirements	Announced retirements and anticipated retirements based on Public Policy Requirements and company commitments*
Resource Adequacy	Target 1-in-10 LOLE
Generation	In-service generation and generation not in service but with an executed service agreement or a State Agreement Approach reservation
Replacement Generation (to meet 1-in-10)	Generation Interconnection Requests**
<small>* Company ESG (Environmental, Social, Governance) commitments to retire resources that are brought to the attention of PJM are included as retirements when there is a commitment to retire resources per legal consent decree or other public statement. ** Additional replacement generation beyond Generation Interconnection Requests may be necessary to achieve resource adequacy</small>	

Exhibit 4. Illustration of Base Reliability Scenario Development Considerations & Assumptions

C.4.2 Analysis

The PJM RTEP long-term reliability review process examines generator and load deliverability analysis for years 6 through 15.

As described in Section 2.3.14 of this Manual, because the assumptions used in the year 8 models are more certain than those used in the year 15 models, and transmission needs identified in the year 8 models have less time to be addressed than the in the year 15 models, the year 8 analysis includes additional reliability criteria and is broader in scope than the year 15 analysis. Year 8 deliverability thermal studies monitor the same facilities and contingencies as in the near-term analysis but the year 15 deliverability thermal studies monitor only 230 kV and up and include only 230 kV and up single and tower contingencies.

C.4.3 Linear Interpolation

The first step of the interpolation of the thermal results is to compile a list of flowgates (monitored facility and contingency pairs) from the near-term and the long-term base case deliverability and any applicable N-1-1 thermal results. The calculated base case AC loadings serve as the starting point for the linear interpolation out through year 15.

- Use year 5 and year 8 thermal loadings from generator deliverability, load deliverability and N-1-1 to determine year 5-8 required in-service dates
- Use year 8 and year 15 thermal loadings from generator and load deliverability to determine year 8-15 required in-service date

Line A-B loading increase from Years 5 through Year 15 using linear interpolation of Year 5, 8 and 15 loadings

Line	Rating (MVA)	Yr 5	Yr 6	Yr 7	Yr 8	Yr 9	Yr 10	Yr 11	Yr 12	Yr 13	Yr 14	Yr 15
A-B	3500	98.0%	98.3%	98.6%	98.9%	99.2%	99.5%	99.8%	100.1%	100.4%	100.7%	101.0%

Exhibit 5. Interpolating Transmission Loadings Over The Planning Horizon

Note that while the simple interpolation approach outlined above for determining required in-service dates for long-lead time transmission enhancements or expansions should be sufficient in the majority of cases, PJM will make the determination whether to apply more detailed approaches, including but not limited to the creation of additional power flow cases and/or the use of distribution factors, to determine the required in-service date of long-lead time transmission enhancements or expansions as appropriate.

C.4.4 Long-Term Upgrades

The outcome of the long-term deliverability analysis will identify the need to include in the RTEP any new long-lead time transmission construction and right-of-way acquisition given forecasted load growth and other inputs concerning the resource mix.

Attachment D: PJM Reliability Planning Criteria

The PJM Reliability Planning Criteria consist of multiple standards and applicable planning principles that include PJM planning procedures, NERC Planning Standards, NERC Regional Council planning criteria, and the individual Transmission Owner FERC filed planning criteria. PJM applies all applicable planning criteria when identifying reliability problems and determining the need for system upgrades on the PJM system. Details of specific criteria applicable to the various stages of reliability planning are discussed along with the corresponding discussion of each procedure found elsewhere in this manual.

The PJM Transmission Owners are required to follow NERC and Regional Planning Standards and criteria as well as the Transmission Owner FERC filed criteria. References to the various planning standards and criteria can be found at

<http://www.pjm.com/planning/planningcriteria.aspx>.

- ReliabilityFirst Approved Standards will be applied for all ReliabilityFirst Bulk Electric System facilities.
- SERC Reliability Criteria will be applied to all SERC networked transmission systems rated 100 kV and higher.
- Transmission Owner standards filed in their FERC 715 filings will be applied to all facilities included in the PJM Open Access Transmission Tariff facility list. Also, interconnections to Transmission Owner facilities are subject to owner standards found at: <http://www.pjm.com/planning/design-engineering.aspx> (these are technical interconnection requirements and do not factor into near-term and long-term planning analyses).

PJM maintains a list (<http://www.pjm.com/markets-and-operations/ops-analysis/transmissionfacilities.aspx>) of all PJM Open Access Transmission Tariff facilities along with which facilities are included in the PJM real-time congestion management control facility list. Both facility lists are referenced in the PJM Reliability Planning Criteria.

The PJM Generator Deliverability Procedure and Load Deliverability Procedure will be applied to all facilities in the PJM real-time congestion management control facility list. These procedures are described in Attachment C.

For all tests, PJM will not accept a loss of load of more than 300 MW. Attachment D-1 contains a description of the various load loss types.

Facilities included in the PJM real-time congestion management control facility list but not included in the applicable regional council planning criteria as defined in section I above will be evaluated against the following criteria. For all tests, PJM will not accept a planned loss of load of more than 300 MW. Attachment D-1 contains a description of the various load loss types referred to in this document. This criterion is in addition to, not in place of, each Transmission Owners Planning Criteria as reported in the FERC 715 filing.

-
- The loss of any single transmission line, cable, generator, or transformer may not result in any monitored facility exceeding the applicable emergency rating or applicable voltage

limit. (The applicable emergency rating and voltage limits will be as defined in PJM

Attachment D: PJM Reliability Planning Criteria

Operations.) The single contingency test will be applied as per the RTEP Generator Deliverability Procedure. (See Attachment C of this PJM Manual 14B.)

- The RTEP base case which includes a 5-year horizon system representation and non-diversified forecasted 50/50 summer peak load will be used for the near-term analysis.
- System load will be represented at an area or zone wide minimum power factor of 0.97 lagging as measured at the transmission / distribution interface point.
- The 300 MW load limit referenced above does not include load that is immediately restored via automatic switching to adjacent substations.
- Automatic or supervisory switching as proposed by the Transmission Owner to sectionalize the system for single contingency events must receive acceptance by PJM Operations.
- During normal conditions with all facilities initially in-service, no uncontrolled load loss or load loss due to automatic schemes is allowed for a single contingency event. Consequential load loss is allowed.

After the occurrence of the transmission line, cable, generator or transformer outage, the system must be capable of re-adjustment such that no facility exceeds the maximum continuous rating or voltage limits as defined in PJM Operations.

During maintenance of any single transmission line, cable, generator, transformer, bus or circuit breaker, the loss of a transmission line, cable, generator, or transformer may not result in any monitored facility exceeding the applicable emergency rating or voltage limit (The applicable emergency rating and voltage limits will be as defined in PJM Operations.) However, for practical purposes, PJM Planning will only include a specific bus or circuit breaker maintenance condition in all future analysis if PJM Operations experiences operational problems as a result of the bus or circuit breaker maintenance condition.

- Pre-contingency generation redispatch will be considered acceptable for mitigation of a potential overload or voltage limit.
- This test will be applied at 70% of the diversified forecasted 50/50 summer peak load, as modeled in the RTEP base case, unless the Transmission Owner provides information to PJM Operations demonstrating sufficient maintenance windows at a lower load level.
- No cascading or uncontrolled load loss is allowed under any circumstance.
- Consequential load loss is allowed.

-
- After occurrence of the maintenance outage and the subsequent facility outage as defined in the previous test #3, the system must be capable of re-adjustment such that no facility exceeds the maximum continuous rating or voltage limits as defined in PJM Operations.

The PJM Light Load Reliability Analysis Procedure will be applied to all facilities in the PJM real-time congestion management control facility list.

Attachment D-1: Load Loss Definitions

Attachment D-1: Load Loss Definitions

Uncontrolled Load Loss – Uncontrolled load loss would require operator interaction to prevent system cascading or to return the system to applicable ratings or voltage limits. Manual load dump as defined in PJM Operations would be included in this category. The PJM Reliability Planning Criteria does not allow for the system design to permit Uncontrolled Load Loss for any contingencies that are studied.

Examples:

- Voltage collapse
- A facility overload without automatic schemes to drop load and with no available generation to re-dispatch pre-contingency.

Consequential Load Loss – Consequential load loss occurs due to the design of the system but does not include automatic schemes designed to drop load under various conditions.

Examples:

- A transformer serving radial load that taps a networked circuit.
- Load that is served from a radial circuit.

Controlled Load Loss due to Automatic Schemes – Controlled load loss occurs due to the operation of automatic schemes that are designed to drop load under specific maintenance conditions.

Planned Load Loss = Consequential load loss + Controlled load loss due to automatic schemes.

The 300 MW total load loss limit is based, in part, on a Federal reporting requirement for major system incidents on electric power systems (refer to Electric Power System Emergency Report Form EIA-417R).

Non-Consequential Load Loss – If situations arise that are beyond the control of PJM that prevent the implementation of a Corrective Action Plan in the required timeframe, then Non-Consequential Load Loss and curtailment of Firm Transmission Service are permitted to correct the situation that would normally not be permitted in Table 1, provided that PJM documents that they are taking actions to resolve the situation. PJM shall document the situation causing the

problem, alternatives evaluated, and the use of Non-Consequential Load Loss or curtailment of Firm Transmission Service.

For Table 1 contingency categories that permit non-consequential load loss, PJM will only use this allowance for facilities that become radial after the contingency. Under such conditions, PJM will not allow any more than 300 MW of non-consequential load loss.

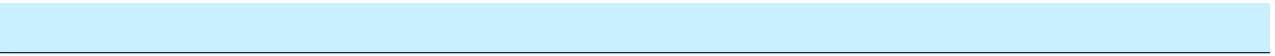

Attachment E: Market Efficiency Analysis Economic Benefit / Cost Ratio Threshold Test

PJM uses a Benefit/Cost Ratio test to determine whether an economic-based enhancement or expansion will be included in the RTEP. Specifically, to be included in the RTEP recommended to the PJM Board of Managers for approval, the relative benefits and costs of the economic-based enhancement or expansion must meet a Benefit/Cost Ratio Threshold of at least 1.25:1. The Benefit/Cost Ratio is calculated by dividing the present value of the total annual benefit projected for the 15 year period starting with the RTEP year defined as current year plus 5 minus benefits for years where the enhancement is not yet in service by the present value of the revenue requirement for the same period. Assumptions for determining the present value of the benefits and costs (e.g. discount rate and annual revenue requirement) will be among the assumptions that are considered by the PJM Board each year to be used in the economic planning process.

The Benefit/Cost Ratio is expressed as follows:

$$\text{Benefit/Cost Ratio} = \frac{\text{[Present value of the Total Annual Enhancement Benefit for the 15 year period starting with the RTEP Year (defined as current year plus five) minus benefits for years when the project is not yet in-service]}}{\text{[Present value of the Total Enhancement Cost for the same 15 year period]}}$$

The purpose of a Benefit/Cost Ratio Threshold is to hedge against the uncertainty of estimating benefits in the future and to provide a degree of assurance that a project with a 15-year net benefit near zero will not be approved. At the same time the threshold is not so restrictive as to unreasonably limit the economic-based enhancements or expansions that would be eligible for inclusion in the RTEP.

E.1 Total Annual Enhancement Benefit

The benefit component of the Benefit/Cost Ratio (Total Annual Enhancement Benefit) is the sum of two metrics: the “Energy Market Benefit” and the “Reliability Pricing Model (RPM) Benefit.” By including these two metrics, the benefits to customers from reductions in both energy prices and capacity prices as a result of an economic-based enhancement or expansion will be taken into account in the formulaic analysis. This comprehensive test captures customers’ benefits in the energy markets and the capacity markets that may correspond to responsibilities related to obtaining reasonably priced energy as well adequate capacity.

Energy Market Benefit

The energy-market benefit analysis is conducted using an energy market simulation tool that models the hourly least-cost, security-constrained commitment and dispatch of generation over a future annual period. A detailed generation, load, and transmission system model is used as input into the simulation tool in order to mimic the hourly commitment and dispatch of generation to meet load, while recognizing constraints imposed on the economic commitment and dispatch of generation by the physical limitations of the transmission system. Benefits of potential economic-based enhancements, PJM will perform and compare market simulations with and without the proposed enhancement for selected future years within the planning horizon of the RTEP. A comparison of these simulations will identify the annual economic impact of the

enhancement for each of the future study years. An extrapolation of these results provides a projection of annual benefits for each of the 15 year period starting with the RTEP year.

The Energy Market Benefit component of the Benefit/Cost Ratio for Regional Projects is expressed as:

$$\text{Energy Market Benefit} = \left[\begin{array}{l} -.50 * \text{Change in Total Energy Production Cost} \\ +.50 * [\text{Change in Load Energy Payment}] \end{array} \right]$$

The Energy Market Benefit component of the Benefit/Cost Ratio for Lower Voltage Projects is expressed as:

$$\text{Energy Market Benefit} = 1 * [\text{Change in Load Energy Payment}]$$

The Change in Total Energy Production Cost is the difference in estimated total annual fuel costs, variable O&M costs, and emissions costs of the dispatched resources in the PJM Region without and with the enhancement or expansion. Costs for purchases from outside of the PJM Region and sales to outside the PJM Region will be captured if appropriate. Purchases will be valued at the Load Weighted LMP and sales will be valued at the Generation Weighted LMP.

The Change in Load Energy Payment is the difference between the annual sum of the hourly estimated zonal load megawatts for each PJM transmission zone multiplied by the hourly estimated zonal Locational Marginal Price for each PJM transmission zone minus the value of Transmission Rights for each PJM transmission zone without and with the economic-based enhancement or expansion. In determining the Change in Load Energy Payments, only zones that show a decrease will be considered in determining the Change in Load Energy Payments.

Reliability Pricing Model Benefit

Reliability pricing benefit analysis is conducted using the Reliability Pricing Model software. The Reliability Pricing Model Benefit component of the Benefit/Cost Ratio evaluates the benefits of a proposed economic-based enhancement or expansion that will be realized in the capacity market and is expressed as:

$$\begin{array}{l} \text{Reliability Pricing Benefit for Regional Projects} \\ \left[\begin{array}{l} -.50 * \text{Change in Total System Capacity Cost} \\ +.50 * \text{Change in Load Capacity Payment} \end{array} \right] \end{array}$$

Reliability Pricing Benefit for Lower Voltage Projects

$$1 * [\text{Change in Load Capacity Payment}]$$

The Change in Total System Capacity Cost is the difference between the sum of the megawatts that are estimated to be cleared in the Base Residual Auction under PJM's Reliability Pricing Model capacity construct times the prices that are estimated to be contained in the offers for each such cleared megawatt (times the number of days in the study year) without and with the economic-based enhancement or expansion.

The Change in Load Capacity Payment is the sum of the estimated zonal load megawatts in each PJM transmission zone times the estimated Final Zonal Capacity Prices (payments paid by load in each transmission zone) for capacity under the Reliability Pricing Model construct

(times the number of days in the study year) minus the value of Capacity Transfer Rights for each PJM transmission zone without and with the economic-based enhancement or expansion. The Change in Load Capacity Payment will be evaluated in the same manner as the Change in Energy Load Payment. Like for the Change in Energy Load Payment, in determining the Change in Load Capacity Payment, only PJM transmission zones that show a decrease will be considered in determining the Change in Load Capacity Payment.

E.2 Total Annual Enhancement Cost

The annual cost of the enhancement is the revenue requirement of the enhancement. The enhancement's annual revenue requirement is an assumption that is developed by PJM and presented to the TEAC for discussion and review. As stated earlier, the benefits and costs will be considered over the same time period, the 15 year period starting with the RTEP year (defined as current year plus 5) minus years where the project is not yet in-service.

Attachment F: Determination of System Operating Limits used for planning the Bulk Electric System

This document describes the process and measures used by PJM to develop System Operating Limits (SOL) and Interconnected Reliability Operating Limits (IROL) used for the planning horizon. In PJM Planning, all BES facilities and “Reliability and Markets” sub-BES facilities, as listed on the PJM Transmission Facilities pages, are considered System Operating Limits (SOL).

Definitions

A System Operating Limit (SOL) is defined as:

The value (such as MW, MVAR, Amperes, Frequency or Volts) that satisfies the most limiting of the prescribed operating criteria for a specified system configuration to ensure operation within applicable reliability criteria. System Operating Limits are based upon certain operating criteria. These include, but are not limited to:

- Facility Thermal Ratings (Applicable pre- and post-Contingency equipment or facility ratings)
- Transient Stability Ratings or Limits (Applicable pre- and post-Contingency Stability Limits)
- Voltage Stability Ratings or Limits (Applicable pre- and post-Contingency Voltage Stability)
- System Voltage Ratings or Limits (Applicable pre- and post-Contingency Voltage Limits)

PJM’s Planning analyses are designed to ensure all applicable PJM, NERC, regional and Transmission Owner criteria are enforced. This is accomplished through exhaustive application of established PJM facility ratings in the on-going system power flow and short circuit analysis. PJM ensures that its exhaustive application of facility ratings are also within system dynamic limits through system dynamic testing. This dynamic testing confirms that PJM system operating limits are not more limiting than the limits established using facility ratings.

Facility Ratings are defined by NERC as:

- The maximum or minimum voltage, current, frequency or real or reactive power flow through a facility that does not violate the applicable equipment rating of any equipment comprising the facility.

Facility ratings determine the fundamental limits of transmission system equipment. SOLs shall not exceed the facility ratings. The facility rating is based on which ever device or component is the limiting element of the facility such as a conductor, current transformer, disconnect switch, circuit breaker, wave trap or protective relay. PJM plans its system such that no facility exceeds the limit/rating consistent with NERC Standard TPL 001-4. Additional information concerning SOL can be found in the Transmission Operations Manual (M-03), and Reliability Coordination Manual (M-37) located on the PJM web page at the following link:

(<http://www.pjm.com/-/media/documents/manuals/m37.ashx>)

Interconnected Reliability Operating Limits are defined as:

An Interconnected Reliability Operating Limit (IROL) is defined as System Operating Limits that, if violated, could lead to instability, uncontrolled separation or Cascading Outages that adversely impact the reliability of the Bulk Electric System. In the planning horizon PJM analyses examine and reveal the violations of applicable criteria. This includes violations affecting PJM monitored facilities at all voltage levels as well as violations that may have widespread impacts affecting the Bulk Electric System and any lower voltage facilities that are monitored by PJM Operations, which may be eligible for designation as IROLs. PJM plans system upgrades for violations of applicable criteria, thus IROL designations are not typically required for the upgraded system in the planning horizon. PJM closely tracks the project status and milestones of all planned upgrades on a frequent and recurring basis. For baseline reliability upgrades, the project tracking is coordinated with the entity that has been designated the construction responsibility, typically the Transmission Owner. If the schedule for implementation for a planned upgrade does not meet in-service date required for system reliability in the planning or operating horizon, PJM will perform additional analysis to determine any alternative plans that need to be taken to ensure system reliability, including the establishment of an IROL. For additional information on IROLs for the operating horizon see the **PJM Transmission Operation Manual (M03)** and the **PJM Reliability Coordination Manual (M37)**.

PJM's Planning methodology to determine IROL facilities simulates transfers across a facility or interface (combination of facilities), comparing thermal and voltage violations associated with a facility. The transfer scenarios used by PJM Planning are established through the application of PJM's deliverability criteria. Additional information on PJM's deliverability criteria is included in Attachment C of this manual. PJM classifies a facility as an IROL facility on the network if wide-area voltage violations occur at transfer levels that are near the Load Dump thermal limit.

As part of the development of the PJM Regional Transmission Expansion plan, SOLs which could result in system instability or uncontrolled cascading outages are identified and system reinforcements are developed. All SOLs are monitored for violations.

SOL and IROL use in Planning

PJM plans its system based on the most restrictive System Operating Limits (such as MW, MVAR, Amperes, Frequency or Volts) of its facilities for the system configurations and contingency conditions that represent the most stringent of the applicable PJM, NERC, regional or Transmission Owner criteria over the planning horizon. The System Operating Limits used to plan the system are consistent with the limits used in Operations. Voltage limits and any exception to those limits are identified in the PJM Transmission Operation Manual (M-03).

An Interconnection Reliability Operating Limit is the value (such as MW, MVAR, Amperes, Frequency or Volts) that is derived from or is a subset of the System Operating Limits, which if exceeded, could expose a widespread area of the Bulk Electric System to instability, uncontrolled separation(s) or cascading outages. PJM Reliability Coordination Manual (M37) defines PJM's methodology for determining, monitoring, and controlling IROL facilities.

Nuclear Power Plant Generator Operators are required to transmit Nuclear Plant Interface Requirement (NPIR) to transmission entities. The transmission entities are required to include those parameters into planning and operational analysis, operate to meet those parameters, and inform the nuclear licensees when those parameters cannot be met for any reason. For

details please refer to Manual M03 Section 3:

<http://www.pjm.com/~media/documents/manuals/m03.ashx>

PJM Planning SOL Methodology

Consistent with the requirements of NERC Standard TPL-001-4 P0, in the pre-contingency state and with all facilities in service, all facilities shall be within their facility ratings and within voltage and stability limits. In the determination of SOLs, the BES condition used shall reflect expected system conditions and shall reflect changes to system topology such as facility outages.

Following single contingencies as defined in NERC Standard TPL-001-4 P1 all facilities should be within their applicable facility ratings and the system shall be transient, dynamic and voltage stable. Cascading outages or uncontrolled separation shall not occur.

Starting with all Facilities in service, the response to a single contingency as defined in NERC Reliability Standard TPL 001-4 P1, may include any of the following:

Planned or controlled interruption of electric supply to radial customers or some local network customers connected to or supplied by the faulted facility. This is often referred to as consequential load loss.

System reconfiguration through manual or automatic control or protection actions.

To prepare for the next Contingency, system adjustments may be made, including changes to generation, uses of the transmission system, and changes to the transmission system topology.

Starting with all facilities in service and following any of the multiple contingencies identified in NERC Reliability Standard TPL-001-4 P2, P3, P4, P5, P6 and P7 the system shall be transient, dynamic and voltage stable and all facilities shall be within their applicable facility ratings and within applicable thermal, voltage and stability limits. Cascading Outages or uncontrolled separation shall not occur. In general, stability is not a limiting constraint in the PJM RTO. Stability limits that have been identified for certain system configurations or following multiple contingencies are identified in the PJM Transmission Operation Manual (M-03). New stability limits identified in Planning are communicated to PJM Operations and included in the Transmission Operation Manual (M-03).

In determining the response to any of the multiple contingencies, identified in NERC Reliability Standard TPL-001-4 P2, P3, P4, P5, P6 and P7, in addition to the actions identified above following single contingencies, the following shall be acceptable:

For all tests, as described in Attachment D-1, consequential load loss of up to 300 MW may occur. For those NERC TPL contingencies that permit non-consequential load loss, PJM will allow up to 300 MW of non-consequential load loss for facilities that become radial post-contingency.

PJM's Reliability Planning methodology for determining SOLs utilizes multiple standards and applicable planning procedures including the PJM Reliability Planning Criteria, NERC Planning Standards (TPL 001-4), Regional Reliability Organization criteria, and individual Transmission Owner FERC filed criteria. In all cases, PJM applies the most conservative of all applicable planning criteria when identifying reliability problems. PJM tests these criteria on a regional basis including all facilities within its footprint. All SOLs are monitored for thermal, voltage and stability violations. Remediation plans are developed to mitigate the violations that exceed the established SOL limits.

PJM's develops models for specific planning horizons using the latest Eastern Reliability Assessment Group (ERAG formerly MMWG) modeling information available for the applicable planning period. A detailed model is utilized for PJM's internal system (transmission owner under PJM's footprint) while the latest ERAG model for that planning period is used for facilities outside of PJM to incorporate critical modeling details of other control areas. Additional information about PJM's base case development procedures can be found in section 2 of this manual.

PJM reliability planning criteria requires that the system be tested for all BES single contingency outages and all common mode outages. Common mode outages consist of line faults coupled with a stuck breakers that result in multiple facility outages, double circuit towerline outages and bus faults in the PJM system. PJM's planning procedures require all NERC P0, P1, P2, P3, P4, P5, P6 and P7 conditions be tested.

When appropriate PJM will identify and implement Remedial Action Schemes. If the scheme is required for reliability purposes, operational performance, or to restore the system to a reliable state following a significant transmission facility event, operation of the scheme will be tested in the on-going planning analysis. See the Transmission Operations Manual (M-03) (<http://www.pjm.com/~media/documents/manuals/m03.ashx>) for additional information concerning Remedial Action Schemes.

The PJM planning process includes a series of detailed analyses to ensure reliability under the most stringent of applicable NERC, PJM or local criteria. Through this process, violations of system operating limits are identified. System reinforcements required to mitigate the violations are developed and included in the Regional Transmission Expansion Plan for implementation. As a result PJM's application of its System Operating Limits for the planning horizon ensures system operation within Interconnection Reliability Operating Limits.

PJM Planning will communicate to PJM Operations any potential IROL facilities resulting from PJM deliverability criteria analysis. PJM Planning and Operations work to develop new IROL Reactive Interfaces and associated operating procedures as required.

Attachment G: PJM Stability, Short Circuit and Special RTEP Practices and Procedures

G.1 Stability

PJM Planning conducts stability studies to ensure that the planned system can withstand NERC criteria disturbances and maintain stable operation throughout the PJM planning horizon.

NERC criteria disturbances are those required by the NERC planning criteria applicable to system normal, single element outage and common-mode multiple element outage conditions. These conditions are specified in the NERC approved Transmission Planning (TPL) Reliability Standards that can be found on the NERC website (www.NERC.com). Because these standards change from time to time they are included here by reference. In addition, PJM's analyses also satisfy the Transmission Owner specific stability practices and procedures as may be applicable when these are more demanding tests than the standard NERC criteria tests applied by PJM. All Transmission Owner specific information and criteria that exceed *standard testing of NERC criteria* and are applicable to PJM reliability based RTEP stability analyses are included or referenced in the Appendix to this Attachment. Transmission Owner stability criteria filed as FERC Form No. 715 and posted on PJM's website and not included in the Appendix may be used to support Transmission Owner funded upgrades. The currently approved version of this Appendix at the commencement of the RTEP process will be the basis for that baseline RTEP and related generator queue assessments. PJM's stability analyses verify satisfactory projected system performance over the range of anticipated load levels and identify any need for upgrades, operating guides, or Remedial Action Schemes that may be indicated based on stability or short circuit testing as a primary driver. In general, the most appropriate remedy to NERC criteria violations is a system upgrade. In circumstances involving criteria that go beyond PJM's standard testing of NERC criteria, operating guides or Remedial Action Scheme remedies may also be considered as discussed further in this Attachment and its Appendix. New Remedial Action Schemes, however are generally avoided and, if considered, require case-by-case review and justification. Also certain specific areas of PJM have been identified through PJM or Transmission Owner analysis as stability limited areas of the system. In such areas of the system, stability operating guides may apply. For related information see PJM Manual 03 at <http://www.pjm.com/library/manuals.aspx>.

Critical system conditions for stability analysis on the PJM system are generally characterized by light load and peak load. System peak load levels shall include a load model where applicable which represents the expected dynamic behavior of loads that could impact the study area, considering the behavior of induction motor loads. An aggregate system load model which represents the overall dynamic behavior of the load is also acceptable where applicable. In exceptional cases, PJM may add alternate load testing when PJM determines that an alternate load level may be the critical load level for system stability for the limitation under review. Peak load stability analysis related to new interconnections of wind turbines and their low voltage ride through performance will also be performed.

System conditions most critical for stability analysis on the PJM system are generally characterized by light load. Peak load analysis is added for stability reviews that involve new connections of wind turbines and performance of low voltage ride through testing. In exceptional

cases, PJM may add heavy load testing for other types of units when PJM determines that heavy load may be the critical load level for system stability for the limitation under review.

PJM's stability analyses ensure the dual objectives of stability of new interconnection projects and system-wide stability. PJM conducts New Service Request stability studies. These analyses ensure newly connecting projects and nearby changes to the system configuration maintain the stability of the project and the system. Study of these projects located throughout PJM provides a thorough, ongoing review of PJM both at the project level and system-wide. In addition, each year, PJM conducts a re-study of one third of existing PJM generation stations. This results in a three-year cycle of on-going re-study of the entire PJM system. PJM also performs additional system-wide stability analyses during the annual RTEP review. In addition, as may be required from time to time, PJM conducts stability analyses to evaluate the dynamic performance of actual or possible major future system developments. For example a proposed new backbone transmission project or prolonged unexpected backbone transmission outage in a stability sensitive area would be cause for a specifically targeted system study. Another cause could be the need to evaluate system performance resulting from major developments affecting power and energy policy.

G.2 Dynamics Procedures

This section provides a high level review of the process of setting up and performing dynamics analyses.

G.2.1 Dynamics Reference Cases

Reference power flow cases for stability analysis are created in a similar manner to that of the power flow reference cases. Additional information, however, is necessary for stability studies to simulate the combined dynamic responses of various power system components. Included in this additional information are dynamics models for generators, excitation systems, power system stabilizers, governors, loads and various other equipment. The required dynamic and other modeling information that must be supplied by generators interconnecting to the PJM system is detailed in Manual 14H. A dynamic simulation links the system model or power flow information with the dynamic data or models to determine if the system and generators will remain stable for steady-state and various disturbances. The current RTEP summer peak case is used as a starting point to create new dynamics cases (light load and peak load.) For example the RTEP analysis is performed for the current year plus five (available early in each calendar year and updated for the five-year-out RTEP analyses in early fall of each calendar year). The stability case setup is for the same study year using the updated RTEP case. This updated RTEP power flow case and the associated stability case become the baseline cases for the Phase II System Impact Studies that evaluate New Service Requests. (In the event that stability analysis is needed beyond the Near-Term, the Long-Term Transmission Planning Horizon portion of the stability analysis shall be assessed to address the impact of proposed material generation additions or changes in that timeframe and be supported by current or past studies and shall include documentation to support the technical rationale for determining material changes.

G.2.2 Dynamics Analysis

The two dynamics cases Originate from the RTEP Power Flow Case that is created for the annual RTEP Plan analyses. The RTEP cycle is depicted in Manual 14B, Exhibit 1. The reference power flow case is reviewed and modified as necessary to correspond to the dynamics database (which includes external world dynamics data from the Eastern Interconnection Reliability Assessment Group's Multi-Regional Modeling Working Group as well as PJM data.) In addition, the case is modified to include generator step-up transformers and explicit modeling of generator station service power use along with gross generator rating. Also, because of the demands of dynamics analyses, constant power load representations in power flow case are replaced with Transmission Owner provided load model representations. In light load representations, pumped storage resources are in pumping mode.

This process is followed to develop stability setups for analysis of all PJM interconnection requests. In addition PJM's system stability analyses will use the most current available setup from this continuous development process.

Testing

After the dynamics model setup, dynamics case initialization and acceptance test are conducted. After case verification, the final, initialized set of power flows and the associated snap-shots, along with the associated dynamic run files are available upon request to Project Developers and others who have a legitimate need for the information, subject to applicable Confidentiality and Critical Energy Infrastructure Information processes (see PJM Operating Agreement §18.17 and <http://www.pjm.com/library/request-access/form-ceii-request.aspx>).

Dispatch

The assumptions used for generation dispatch can be critical to the results. It is generally accepted that units operating at their highest possible power output and generating as little reactive power as necessary to maintain voltages are likely to be less stable. Normally, and to the extent where no resulting thermal overloads occur under system normal and N-1 contingency conditions, the units in the vicinity of the project under study as well as the study unit(s) will be turned on to their maximum real power output with unity power factor at the high side of the GSUs, or units' VAR output will be adjusted to hold scheduled voltages, depending on specific Transmission Owner criteria. Wind facilities are tested at light load for stability and peak load for low voltage ride through at 100% of their maximum energy value. In addition, stability test scenarios necessitated by any applicable Transmission Owner operating guides will also factor into each analysis.

Simulations to determine required upgrades (also see the Appendix to this Attachment)

Fault Criteria:

- **Fault Types:** For interconnection and system stability analyses, three phase faults, single line to ground faults with stuck breaker and single line to ground faults with the communications failure cleared within zone 2 time will be examined. Each analysis will include a determination of the most critical faults to apply. Planning events expected to produce more severe impacts shall be identified. A list of these contingencies as well as the rationale for selection shall be available as supporting information.

- Clearing Times: Dynamic simulation issues are identified using estimates of actual (nominal) clearing times, including relay trip times, breaker interrupting time, fault extinguishing time, intentional delay time, and a margin for error.
- Reclosing: Only high speed reclosing (less than one second) is modeled if present. Successful high speed reclosing and unsuccessful high speed reclosing into a fault where high speed reclosing is utilized will be examined.
- Fault locations: For interconnection analysis, see section G.3.2 New Service Request Stability Study Procedure. For system analyses, the scope will determine the most critical locations to apply criteria faults.
- Maintenance outages: Interconnection analyses of planned line maintenance outage conditions prior to fault application are system conditions that can be anticipated and that are generally of limited duration. The least cost remedy to issues during such system conditions is to require generation to curtail output. Such analyses are, therefore, of primary interest in the operating horizon and are not generally considered to determine upgrade facilities required prior to interconnection. Nevertheless, prior to commercial operation, or prior to completion of the Phase II System Impact Study at the request of the Project Developer, Planning will screen critical faults for issues during line maintenance. The results of the line maintenance study will be conveyed to PJM Operations, the Project Developer, and affected Transmission Owners.

PJM addresses Power System Stabilizer (PSS) outages in a similar fashion. If there are existing PSS installations nearby a new interconnection or if PSS is required on the new interconnection, critical faults for the outage of these devices will be studied prior to commercial operation and the results will be conveyed to PJM Operations, the Project Developer, and affected Transmission Owners.

- Tripping of transmission lines and transformers where transient swings cause protection system operation shall be analyzed using generic relay models.
- For NERC Transmission Planning events P2 through P7: When a generator pulls out of synchronism in the simulations, the resulting apparent impedance swings shall not result in the tripping of any transmission system elements other than the generating unit and directly connected facilities. Directly connected facilities for this requirement are facilities intended to or designed to trip as a consequence of the out-of-step event.

Margins:

The margins applied by PJM are intended to be applied in System Impact Study stability analysis that uses a project's final stability study data as further discussed below. As such, these margins account primarily for uncertainty in actual clearing times, and the final data represents the "as built" performance. With the machine modeled at net unity power factor at the high-side of the GSU (or unity power factor at the generator terminals for wind turbine installations), transient stability must be maintained for tested faults when the following margins are included:

- Add 0.25 cycles to the nominal primary clearing time for 3 phase, normally cleared faults.

- Add 0.25 cycles to the nominal primary clearing time for single-line-to-ground faults, plus an additional 0.5 cycles added to the nominal backup clearing time for stuck breaker (.75 cycle total clearing time margin).
- Add 0.25 cycles to the nominal primary clearing time for single-line-to-ground faults, plus an additional 1.25 cycles to the nominal Zone 2 clearing time for failure of primary relaying (1.5 cycle total clearing time margin).

Monitoring requirements:

Rotor angle, real/reactive power output, EFD, speed and terminal voltage of units under study are monitored. Bus Voltages in the same area are also monitored.

Acceptable Transient Voltage Recovery

When a fault occurs on the transmission system, system voltages are temporarily reduced. Once the fault is cleared, voltages follow transient voltage recovery trajectories governed by system dynamics.

The transient voltage recovery criteria should be satisfied at BES buses.

Regardless of the load model that is selected, the voltage following fault clearing shall recover to a minimum of 0.7 p.u. after 2.5 seconds. If a plant-specific document (such as NPIR) or local Transmission Owner specific planning criteria requires a more conservative voltage recovery criterion that specific criterion will be applied. More conservative limits may be agreed upon by PJM and the TO.

Acceptable Damping:

Following the disturbance, the oscillations of the monitored parameters display positive damping. The positive damping is determined with a damping coefficient calculation algorithm. This characterizes the degree of positive (damped) or negative (undamped) damping based on the damping trend, over the duration of the stability run, of the envelope of machine angle oscillation peaks. This trend can be observed by drawing an envelope connecting each succeeding peak or valley of the oscillation of the monitored element. An acceptable oscillation envelope will demonstrate a positive decay within the appropriate test period (normally 10 to 15 seconds). A sustained oscillatory system response, even if slightly damped, will cause the system to be in a vulnerable state and exposed to adverse impacts for subsequent changes to the system over some prolonged time. To limit this system exposure PJM uses a 3% damping margin. Such positive damping demonstrates an acceptable response by the system, and no further analysis is required. Failure to meet the damping standard will require application of some combination of power system stabilizers, excitation system upgrade and tuning, and system upgrade.

G.3 New Service Request Stability Study Procedures

PJM performs New Service Request stability analysis as a part of the Phase II System Impact Study. PJM's standards for stability analyses satisfy NERC criteria and are the generally applicable criteria for all PJM stability analyses. In addition, Transmission Owner stability criteria may apply. PJM or Transmission owner analysis have identified certain specific areas of PJM as stability limited areas of the system. In such areas, stability operating guides may apply. See

PJM Manual 03 at <http://www.pjm.com/-/media/documents/manuals/m03.ashx> for more information on PJM stability operating guides.

G.3.1 New Service Requests Stability Data Requirements

PJM Manual 14H details data submission requirements for each phase of the Cycle process..

G.3.2 New Service Request Stability Study Procedure

This section outlines the process of coordination and execution of the stability study among the representatives of PJM, the Project Developers and Transmission Owners during a Cycle. These procedures apply to stability studies required as part of the New Service Requests process. These stability studies identify needed reinforcements and determine cost responsibility for these reinforcements due to New Service Requests stability issues. The upgrade responsibilities become part of the Generation Interconnection Agreement (GIA).

During Phase I, all verified and accepted Dynamic Models submitted by each Project Developer will be added to the selected dynamics basecase (light load, winter peak load, and/or summer peak load) being used for that Cycle. The New Service Requests in that Cycle will be grouped into clusters based on the stability clustering methodology. Once the clusters are identified, the New Service Request will remain in that cluster until the end of the Cycle, or until it withdraws. A scope of work will be developed for each cluster of projects, which will include, but not be limited to the following items:

1. A list of the projects included in the cluster along with a brief description of each project's POI location, MW size and other relevant information. The stability evaluation is performed at the maximum MW output specified for the project.
2. A detailed fault list to test NERC, PJM and Transmission Owner criteria faults, as applicable. The fault specification list will include:
 - a. Fault location
 - b. Phase involvement
 - c. Fault Impedance
 - d. Clearing times and reclosing, if applicable
 - e. Explicit timing or other margins to be added
 - f. Justification of any procedures that exceed PJM standard methods

At a minimum, faults will be developed at the POI bus and one bus away from that bus. In addition, other fault locations judged by PJM as critical to cluster response will be added to the scope.

3. For areas in the cluster affected by established operating guides or Remedial Action Schemes (RAS), as noted in Manual 03, scenarios designed to test the proper operation of the existing guides or RAS may be included, as deemed necessary by PJM. In such cases, the scope will be augmented to examine and specify modified procedures or facilities that ensure the integrity of the system operation.

4. All special study conditions, scenarios or simulations, if any, required by guides or sensitive areas and specific clearing times.
5. A table listing the generating units that will be dispatched for the cluster stability study.

The affected Transmission Owner(s) will have five business days to review the scope of work developed, and provide comments/input to PJM representatives if any additional specific scenarios should be considered. The finalized scope of work will be used for the stability study in Phase II.

During Phase II, changes from Decision Point I will be incorporated into the dynamics basecase, the stability clusters and scope of work, as needed. Contingencies for the faults in each cluster are created. The stability study is run based on the scope of work developed for the cluster. If any issues are identified in the stability results, the Transmission Owner will provide upgrades to mitigate the instability, along with cost and time estimates. PJM will review and test the upgrades to verify it resolves the issues identified. Cost allocation will be done in accordance with M14H Att 02. The completed stability study report and results are sent to the affected Transmission Owner(s) to review. Upon completion of the Transmission Owner review PJM will issue the final Phase II System Impact study report to the project developer.

In situations when the required system modifications or upgrades cannot be accomplished by the projected in-service date of the project, PJM will develop a scope and schedule to determine interim solutions and dates along with provided interim capability.

During Phase III, changes from Decision Point II will be incorporated into the dynamics basecase as needed, and if a restudy for a cluster is required, it will be performed during Phase III. The process to restudy and finalize the stability study results is the same as outlined in Phase II above.

Changes during Decision Point III will be incorporated on an as needed basis for each cluster.

G.4 System Stability Studies

In addition to the stability analyses of new generating interconnections, the three year cycle testing of all existing generating units interconnected to the PJM system, and certain “ad hoc” stability testing required by special circumstances that occur from time to time, PJM also conducts system stability testing of its most critical stressed system conditions during the annual Regional Transmission Expansion Plan study cycle. The RTEP stability testing examines and ensures system performance within criteria for heavy system transfer conditions. Power flow criteria are ensured on a local and system-wide basis for heavy transfers during the application of PJM’s load deliverability testing (see Manual 14B Attachment C.) These test scenarios examine emergency conditions involving extreme generating outages and loads coupled with single transmission element outages. Such circumstances are critical when the system is stressed at heavy load, rather than light load.

Based on the results of each annual RTEP cycle and previously completed stability analyses, PJM determines the load delivery limits for the case that represents the most critical conditions for PJM system stability testing. The transfers into the selected Region emanate from external PJM and non-PJM generation. Imports from external areas are based on historical levels for heavy load. An example of the type of PJM scenario that could represent the critical study condition may have local load of 65,000 MW with a transfer into the area caused by the simultaneous outage about 10,000 MW of internal area generation. This may cause a thermal limit to transfers well in excess of 6000 MW.

The transmission outage that sets the limit for transfers during the Mid-Atlantic load delivery testing is modeled for stability to ensure that the region is not stability limited. PJM also determines several more critical three-phase and single-line-to-ground fault tests to apply from a stability perspective to ensure robust, stable and adequately damped system performance. Fault testing for system stability includes the most critical Bulk Electric System lines.

G.4.1 NERC P3 and P6 “N-1-1” System Stability Studies

INTRODUCTION

An N-1-1 contingency pair is defined as a single line to ground (SLG) or 3-phase fault with normal clearing, manual system adjustments, followed by another SLG or 3-phase fault with normal clearing. In the NERC TPL standard, N-1-1 contingencies belong to P3 and P6. Manual adjustments after first (N-1) contingency are allowed to relieve any thermal or voltage violations for applicable ratings and/or to prepare for second (N-1-1) contingency. N-1-1 stability analysis is defined as a stability analysis for given N-1-1 contingency scenarios. For a given N-1-1 contingency scenario, the first (N-1) contingency is applied to a pre-disturbance base case. If the system is stable, a new operating point is computed and manual adjustments are made if necessary, and then stability is monitored following second (N-1-1) single contingency. Because of the assumed long time delay (from a stability point of view) between two single contingencies, the N-1-1 stability analysis is similar to maintenance outage study for operational guidelines.

DISPATCH

Initial base case creation for N-1-1 stability analysis follows the procedure in Attachment G, section 2.2. When an N-1 base case is created, care needs to be taken before an N-1-1 contingency is applied. First, all thermal or voltage violations in the N-1 base case should be resolved through system adjustment. Second, if available, any existing operating guidelines for the N-1 outage condition needs to be applied to the N-1 base case.

N-1-1 STABILITY ANALYSIS PROCEDURE

Considering the number of generating machines in the PJM system and the number of possible N-1-1 contingency pairs, it is very challenging to cover all of them within a reasonable lead time. In general testing all N-1-1 contingency pairs for stability is impractical and not necessary due to the fact that most contingency pairs are electrically far away from a study plant or independent from each other. It is essential to screen out critical contingency pairs which have potential stability problems without missing any potentially unstable N-1-1 contingency pairs.

Overall procedure of N-1-1 stability analysis for generating units in PJM area is as follows:

- Selection of plants for the N-1-1 stability study
 - o The scope of annually studied plants will include the same plants included in the scope of the baseline stability study that year. Similar to the baseline stability study, one third of generators in PJM will be considered for the N-1-1 stability analysis each year resulting in every PJM generator being studied at least once every three years.
 - o If PJM Transmission Planning determines that the scope cannot be completed within a reasonable lead time, PJM Transmission Planning will prioritize the plants in the scope of the study and higher priority plants will be studied first.
 - o With the request of PJM Operation or Transmission Owners due to special operation need, the study for specific plants would be performed.
- Selection of N-1-1 contingency pairs for each plant.
 - o N-1-1 contingency pairs within one bus from the high tension bus of the study plant are tested. If the number of branches connected to the high tension bus is less than three, the boundary of N-1-1 contingency pairs is extended to two buses away.
- Conduct N-1-1 stability study
 - o Assume N-1 stability results are available from the baseline stability analysis.
 - o If an N-1 contingency is transient unstable, the N-1 stability issue must be resolved first. For each N-1-1 contingency pair, create an N-1 base case by solving a power flow after the N-1 contingency is applied to the N-0 base case. If there are any thermal or voltage violations, resolve them through system adjustments. Also if available, apply existing operating guidelines for the N-1 outage condition to the N-1 base case.
 - o Conduct comprehensive time-domain simulation for the N-1-1 contingency and assess stability.
 - Following standard PJM stability criteria, both transient stability and damping will be monitored
 - o Consider RASs or other specific operating guidelines.

STUDY PLANTS SELECTION

The factors taken into account in prioritizing plants include the size of a plant, N-1 baseline stability study results, plant fuel type, and the unavailability rate of neighboring branches of the study plant. The following plants are given the highest priority for the N-1-1 stability study.

- Nuclear plants take the highest priority and will be studied if they are in the scope of the annual baseline stability study
- Plants with the maximum output of 1000 MW or above.
- Plants having weak stability performance in baseline stability study.
- Plants that experienced operational stability issues in real-time.
- Plants having neighboring branches with high unavailability rate due to planned and/or unplanned outages.

N-1-1 CONTINGENCY SELECTION

Due to the number of combinations of N-1-1 contingencies, only single contingencies that are 1-bus away from the high-tension buses of the study plant are considered. In the example below, five single transmission line outages are considered in the N-1-1 stability study as shown in Fig. 1.

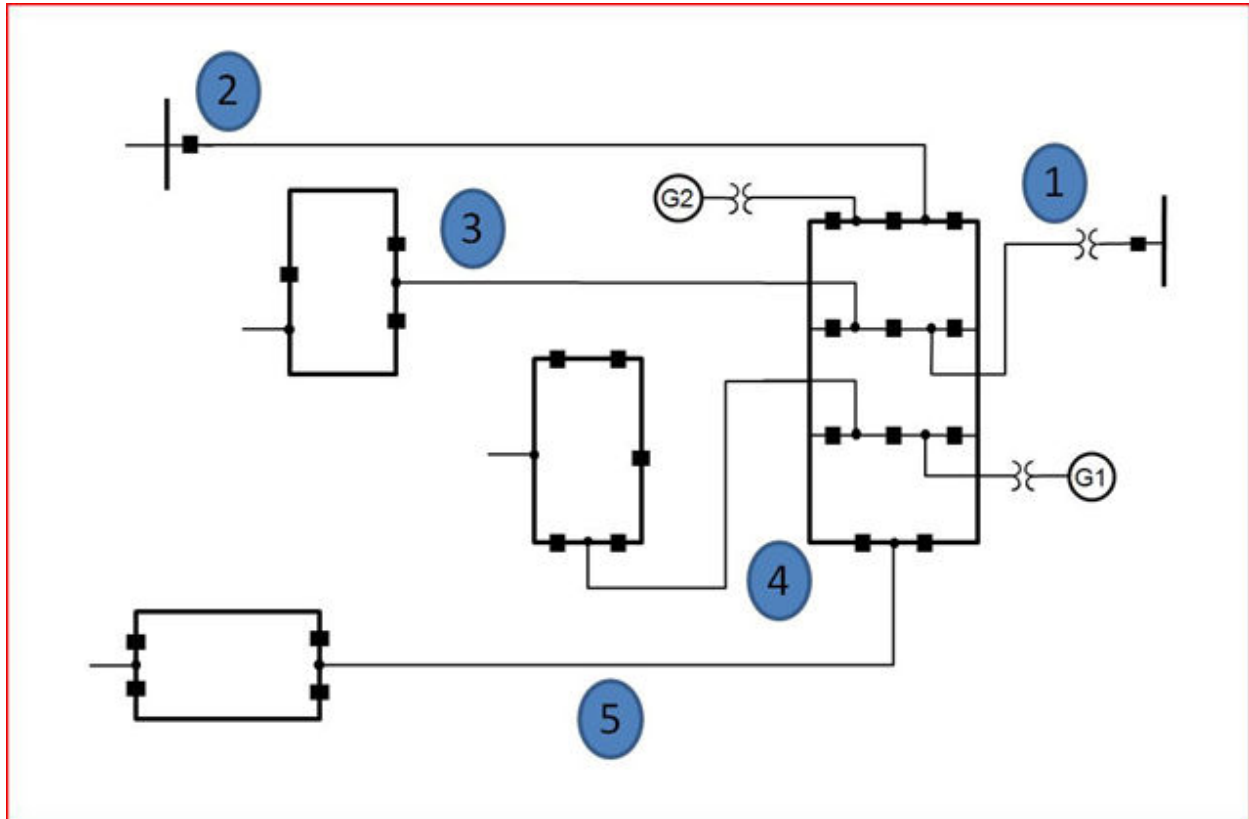

Figure 1 – Example of Five transmission lines for the N-1-1 stability study of a generic location.

It is necessary to analyze total 25 (5 N-1 and 20 N-1-1 contingency scenarios) contingency scenarios for the example plant in Figure 1. It is also noted that 3-phase fault cleared by primary relays is considered for all single contingencies. Fault clearing times are in form of possible ranges for different areas, kV and fault clearance options and the upper values of the respective ranges are used. Existing Remedial Action Schemes are, if available, incorporated in the N-1-1 contingency scenarios.

MITIGATION

Any violation of PJM or other applicable stability criteria as described in this Attachment will be addressed and documented as part of the annual RTEP process.

G.5 Impact Study Procedures Applicable to Wind Turbine Analyses

PJM follows a process of procedures and studies when handling requests to interconnect to the transmission system. These procedures are outlined in PJM Manuals and agreements, particularly PJM's Manuals 14H and 14B and the PJM Open Access Transmission Tariff

(OATT.) In recognition of some of the unique characteristics and challenges posed by wind projects, however, the PJM OATT procedures include certain special provisions applicable to wind farm interconnection requests. Project Developers should familiarize themselves with all applicable PJM procedures and requirements, in consultation with their assigned PJM project manager. Some provisions of particular interest to wind interconnection requests can be found in OATT PART IV, Subpart A, PART VI, Subpart A, and Part IX, Subpart B.

G.5.1 Wind Project Final Impact Study Data

Upon entering the New Service Request process wind generators may submit approximate data for the Phase I System Impact Study that represents the wind farm as a single equivalent unit. Prior to commencement of the wind farm impact study the approximate data must be replaced with detailed design data including the detailed electrical layout of the wind farm. This data is required for wind farm projects, by tariff provisions, no later than six months after the filing of the interconnection request. As described in the general discussion of stability study procedures, final impact study data is generally required at the beginning of the system impact study process which often will happen to be about six months after the close of the queue. In the case of wind projects, tariff requirements ensure that the data may be supplied up to six months from the initiation of the queue request. In practice the wind farm developer, as well as all project developers, should maintain good communications with the assigned project manager to determine when PJM is scheduled to begin a specific project's stability analysis.

G.5.2 Wind Project LVRT Requirements

In addition to all facets of the standard stability study scope previously discussed, wind generators will be studied during their impact study stability analysis for compliance with the Low Voltage Ride Through Criteria (LVRT.) The LVRT criteria tests the ability to the wind farm generator to maintain operation and interconnection with the system during events that cause extremely low voltage transients as measured at the high side of the transformer that steps up the Wind Farm's voltage to the transmission system (high side of the wind farm GSU.) Peak load conditions are the most stressful for maintaining system voltage so this analysis will be conducted on a peak load power flow model (in contrast to the standard stability analysis that is conducted on an off-peak model.) Based on the results of the standard stability analysis, PJM will determine the most critical three phase faults with normal clearing and phase to ground faults with delayed clearing. The wind generator will be required to maintain its power output to the system following three phase faults cleared in up through 9 cycles (9 cycles includes any applicable margins) and that produce a voltage as low as zero at the high side of the GSU. Actual clearing times plus applicable margins will be used, which may be less than 9 cycles and high side GSU voltages may be somewhat greater than zero. Also the wind farm must maintain output to the system following the most critical phase to ground faults with delayed clearing, using actual clearing times. Applicable clearing time margins will apply to the LVRT test.

G.5.3 Wind Project Reactive Power Modeling

Stability tests will be conducted on a system model with the GSU modeled and zero generator reactive power output (unity power factor.) When power flow analysis does not model the generator step up transformer, the zero generator reactive power output is applied at the collector bus. This base case and the stability analysis will establish power factor or reactive power delivery requirements only if impact study analysis is conducted that demonstrates that the safety or reliability of the system is impacted by the lack of the requirement. System

transient, oscillatory, or voltage instability during any phase of the impact study is evidence of system safety or reliability impact. For such results, the least cost remedy that considers system protection, transmission upgrades, or reactive requirements will be determined and specified.

In the event that the transient or voltage instability only affects the wind project (for example when long radial interconnection facilities cause the inability of the wind facility to remain stably interconnected), the wind project will be notified and be requested to provide project design remedies. PJM's analysis of possible remedies will be limited to specifying the size of dynamic reactive device or increased transmission interconnection capacity if such a remedies are sufficient.

G.6 Stability Analyses of Stability Sensitive Local Areas in PJM

The PJM system generally operates to limits determined by thermal and reactive criteria. In some specific instances local areas of PJM or individual plants operate to stability limitations. The PJM transmission system conditions and procedures due to localized thermal, reactive and stability considerations are outlined in PJM Manual 03.

The PJM Transmission Owners are often owners of the facilities that are subject to these procedures and carry out PJM's operating instructions ensuring safe and reliable operation consistent with these guidelines and procedures. PJM, therefore, closely coordinates review of the stability guides and procedures with the Transmission Owners and, when appropriate, Transmission Owners may conduct analysis, subject to PJM's review.

Stability guides applicable to specific plants are reviewed as part of PJM's three year cycle of generator stability analysis that ensures continued compliance with NERC criteria. Local stability guides and procedures are reviewed as necessary when interconnections or transmission changes cause the need for review. Each review is specific to the area or plants operating procedures and guides and confirms or develops modifications to the guide and system upgrades, as appropriate, to maintain reliable operation within applicable criteria.

G.7 Short Circuit

PJM performs short circuit analysis as part of the annual Regional Transmission Expansion Plan (RTEP) baseline assessment. This analysis includes a study of the entire PJM system based on its current configuration and equipment to determine if the short circuit current interrupting duty of circuit breakers is sufficient for the 2 year planning case. In addition, PJM also performs the analysis on the planned system configuration using a 5-year out case. Additional sensitivity studies are performed on years 3 and 4 as needed. The generation and merchant transmission interconnection process (see Manual 14H) also includes short circuit analysis for each requested new interconnection project. The addition of new sources and BES equipment drives most breaker replacements. PJM Planning conducts short circuit analysis to ensure the high-voltage circuit breakers on the transmission system are sufficiently rated to safely interrupt fault currents. These short circuit studies are also referred to as breaker interrupting studies. Since new sources only become committed with relative assurance a few years before scheduled commercial operation and since breaker replacement lead times are only a few years, these analysis are only conducted within the 5-year planning horizon.

The short circuit analysis is performed in accordance with the following industry standards:

- ANSI/IEEE 551-2006 “IEEE Recommended Practice for Calculating Short-Circuit Currents in Industrial and Commercial Power Systems”
- ANSI/IEEE C37.04-1999 “IEEE Standard Rating Structure for AC High-Voltage Circuit Breakers”
- ANSI/IEEE C37.010-1999 “IEEE Application Guide for AC High-Voltage Circuit Breakers Rated on a Symmetrical Current Basis”
- ANSI/IEEE C37.5-1979 “IEEE Guide for Calculation of Fault Currents for Applications of AC High-Voltage Circuit Breakers Rated on a Total Current Basis”

The system condition most critical for short circuit analysis on the PJM system is all available generation in-service. This condition is modeled in short circuit reference cases that are specially configured for short circuit analysis. PJM Planning maintains the following short circuit base case representations and associated data:

- 2 year planning representation consisting of the current system plus all facilities planned to be in-service within the next 2 years.
- 5 year planning representation using the 2 year planning representation as the base model and including all system upgrades, generation projects, and merchant transmission projects planned to be in-service from years 2 through 5. This 5 year planning representation is consistent with the PJM RTEP 5 year load flow base case.
- Data file containing current circuit breaker interrupting ratings and other relevant circuit breaker nameplate data for all BES circuit breakers.

The short circuit base cases are maintained using Aspen One Liner and short circuit analysis is performed using the Aspen Breaker Rating Module. The PJM short circuit 2 year planning representation is developed annually with the assistance of the transmission owners and maintained by the PJM Planning.

G.8 Nuclear Plant Specific Impact Study Procedures

Stability analysis of nuclear facilities is conducted during PJM’s three-year cycle of stability review of all existing generating units. Also, interconnections or transmission modifications in the vicinity of existing generating stations, including nuclear stations, may necessitate additional reviews. PJM conducts these reviews consistent with the NERC criteria and certain added criteria specified by the Transmission Owner or plant operator or owner. PJM stability studies take into account coordination with any applicable Remedial Action Schemes. Results of PJM Planning analyses can be found under the “planning” tab material and “committees & groups” tab material on PJM.com particularly:

<http://www.pjm.com/planning/planning-criteria.aspx> <http://www.pjm.com/planning/rtep-development.aspx> <http://www.pjm.com/planning/generation-interconnection.aspx>
<http://www.pjm.com/committees-and-groups/committees/teac.aspx>

PJM will notify PJM System Operations and the affected Transmission Owner in the event that PJM’s planning analyses indicate planning study results that violate PJM planning criteria or

nuclear specific planning criteria. In addition, results of PJM Impact Studies affecting nuclear facilities are communicated to the affected Nuclear owner and operator.

PJM applies some nuclear plant study procedures that exceed *standard NERC criteria* to be consistent with certain regulatory and safety requirements specific to these facilities. Material contained in the Appendix to this Attachment G provides Nuclear Plant Interface Requirements (NPIR) regarding the nuclear specific testing procedures applied by PJM and Transmission Owner Planning.

G.9 Appendix to Manual 14B Attachment G

This appendix contains Transmission Owner specific criteria applicable to RTEP stability study analyses that may go beyond the NERC system stability performance tests routinely applied by PJM. PJM normal stability testing enforces the NERC criteria that are based on single contingencies and common-mode multiple contingencies. PJM does not permit planned load loss or interruption of firm transmission service for these events, even when such service curtailment may be permitted by the NERC standards. These contingencies are also referred to in this Attachment and Appendix as the “standard” NERC criteria and include the following events:

- System normal,
- Single phase and/or three phase fault (N-1),
- Single phase fault stuck breaker (N-2),
- Three phase fault tower (N-2), and
- Single Phase fault and communication failure (N-2).

More stringent NERC criteria that involve multi-phase faults, non-common mode multiple contingencies, and higher order contingencies (also referred to as “beyond” *standard NERC criteria*) do not routinely form the basis for required PJM RTEP upgrades. Some Transmission Owner criteria, however, as detailed in this Appendix, go beyond the *standard* PJM stability screening criteria and do require remedies. These procedures, as applicable, are applied during PJM RTEP (including interconnection related) stability analyses in addition to PJM thorough testing of *standard NERC criteria* tests and system performance is verified to be stable and within criteria. The Transmission Owner specific criteria are limited to interconnections with the transmission facilities of the respective Transmission Owners.

All PJM testing applies the clearing margins and damping criteria discussed in Attachment G and more stringent criteria when the specific Transmission Owner criteria exceed these standard margins. In all cases PJM applies the criteria in a comparable and not unduly discriminatory fashion to new interconnection projects and existing generators. Violations based on *standard NERC criteria* and standard margins must be remedied by upgrade modifications to the system. Operating curtailments will generally be an available remedy for issues found for line maintenance outage tests.

G.9.1 Testing of Transmission Owner Criteria

For New Service Request process studies that pass the *standard* NERC and PJM criteria but produce localized violations based on criteria that are beyond the *standard NERC criteria* and/or margins that exceed standard PJM margins, PJM, in consultation with the affected Transmission Owners, will determine lower cost remedies. For these Transmission Owner tests, planned load loss or interruption of firm transmission service is not allowed when lower cost remedies are available. An available lower cost remedy will be required to address such violations. For example, lower cost remedies that may be considered include:

- Relaying modifications
- Sectionalizing schemes
- breaker upgrades
- Independent pole tripping
- High speed breaker failure schemes
- High speed reclosing
- Fast closing of steam intercept valves
- Braking resistors.

If the search for lower cost upgrades produces none, or in the case of wide-spread system violations such as may be encountered during RTEP baseline stability analysis, then PJM, in consultation with the affected Transmission Owners, will make a more detailed assessment of the violation(s) including factors such as the extent of violations, the events' likelihood, system impact and cost to remedy. Based on the gathered information, PJM will specify a remedy including possible consideration of operating guides, Remedial Action Schemes, and more extensive high voltage upgrade options. See Transmission Owner Planning Criteria at <https://pjm.com/planning/planning-criteria/to-planning-criteria> for more information.

G.9.2 Nuclear Station Testing

With regard to nuclear station related planning stability analysis, in addition to the *standard NERC criteria* and specific Transmission Owner criteria testing, PJM reviews and enforces criteria testing that can be found under the Planning section of the Nuclear Plant Interface Requirement (NPIR) documents. In some cases the Transmission Owner also performs special nuclear unit stability testing as described in PJM Manual 39 and the NPIR. Together, the analyses that may be performed by the Transmission Owner and PJM's testing incorporate the voltage and stability requirements of the station. PJM ensures Transmission System performance to the specified criteria that enables the station equipment and systems to perform as designed. Nuclear voltage criteria at the Transmission System level, including any voltage drop criteria, are enforced on a system normal and post-contingency basis as described in the NPIR planning requirements. Observed criteria violations during planning assessments affecting nuclear stations will be evaluated jointly by PJM Planning and PJM Operations consistent with procedures outlined in PJM Manual 39. Appropriate remedies, consistent with this Attachment and the PJM Manuals and Agreements, will be specified to ensure applicable criteria are met. As part of these analyses redispatch of nuclear units is not permitted in an effort to relieve violations. The nuclear owner will be responsible for reinforcements necessary to comply with

criteria that are specific to the Nuclear Plant and that are more stringent than the standard PJM and Transmission Owner tests.

The specific nuclear unit planning criteria contained in the NPIR documents are included in the Appendix to this Attachment G when the nuclear plant owner has consented to these excerpts being included here for convenient planning reference. In any instances of a nuclear plant owner preference to maintain confidentiality of this information, it is not reproduced in this manual but is still evaluated and enforced during planning studies.

G.9.3 BG&E Specific Criteria

Additional stability testing applicable to interconnections with BG&E transmission facilities includes tests of three-phase faults at a point 80% of the circuit impedance away from the station under study with delayed (zone two) clearing.

G.9.4 ComEd Specific Criteria

Additional stability testing applicable to interconnections with ComEd transmission facilities includes:

- Three-phase fault on any transmission or generation element with delayed clearing due to a stuck breaker or other protective equipment failure. For situations involving independent pole operated breakers, it is assumed that only one phase of the breaker fails to open and the delayed clearing time is used for the remaining single-phase fault.
- Three-phase fault on any transmission or generation element with delayed clearing due to failure of a Remedial Action Scheme.
- Three-phase fault on all transmission lines on a multiple circuit tower with normal clearing.
- Three-phase fault on any transmission or generation element during the scheduled outage of any other transmission or generation element.

It should be noted that a one-cycle margin is included in all primary-clearing times for faults on the ComEd system, instead of the PJM margins. For more severe, lower probability events such as faults occurring during maintenance outages or faults cleared in delayed time, if lower cost remedies are not available, PJM will retest with the PJM's standard margins as a possible remedy.

The dynamic voltage recovery (DVR) criteria should be satisfied at buses categorized as BES facilities at peak load, given all transmission elements are in 'normal' configuration preceding the event. Following a three-phase fault on the transmission system that results in loss of a single generator or transmission element, the transmission system DVR must conform to the recovery 'envelope' described below.

- Following the successful clearing of a fault (normal clearing = 6 cycles), the voltage magnitudes should be no less than 70% of their nominal values.
- Within 20 cycles following the clearing of a fault, the voltage magnitudes should be no less than 80% of their nominal values.

- Within 0.5 seconds following the clearing of a fault, the voltage magnitudes should be no less than 90% of their nominal values.
- Within 1.5 seconds following the clearing of a fault, the voltage magnitudes should be no less than the steady-state voltage minimum, typically 92-95% of nominal.

Violation of the DVR criteria can increase the potential for severe voltage problems following a fault and should be mitigated with appropriate reinforcements.

G.9.5 PPL Specific Criteria

Additional stability testing applicable to interconnections with PPL transmission facilities includes:

- **Stuck Breaker and Relay Failure:** Permanent three-phase fault with stuck breaker or other cause of delayed clearing.
- **Double Circuit Tower (DCT) Line Fault:** Permanent three-phase fault involving both circuits of a double circuit line with normal clearing and reclosing sequences, if applicable.
- **Overtripping:** Permanent three-phase fault on one line with an overtrip of another unfaulted line. Both the overtrip and clearing of the faulted line occur in normal primary clearing time. Reclosing sequences, if applicable, should be included.

If assessment of any of the contingency types noted above results in identification of stability concerns in the PPL system, see the table below to determine if a reliability solution is required by PPL (“should be stable”), or if the study results should be reported to PPL for information only (“information only”) for awareness and further consideration of the severity of the consequences of the event.

Contingency	TPL-001-4 Contingency Category	Clearing Time	Fault Type		
			230 kV and Above	100 - 229 kV	< 100 kV
Stuck Breaker	E2-A through D	Breaker Failure Clearing Time	3PH (information only)	3PH (information only)	Not Applicable
Relay Failure	E2-A through D	Zone 2 Clearing Time	3PH (should be stable)	3PH (information only)	Not Applicable
DCT Line Fault	E2-F	Normal Clearing Time	3PH (information only)	3PH (information only)	Not Applicable
Overtripping	E2-F	Normal Clearing Time	SLG (information only)	SLG (information only)	Not Applicable

G.9.6 Implementation of the NPIR for Planning Analysis

PJM incorporates the Nuclear Plant Interface Requirements (NPIRs) into its planning processes in accordance with the applicable NERC standards. PJM performs these planning analyses consistent with the NPIR planning requirements and its Regional Transmission Expansion Planning requirements.

G.10 NERC Standard PRC-023 – Transmission Relay Loadability

Background

The purpose of the standard is to ensure that protective relay settings shall not limit transmission loadability; not interfere with system operators’ ability to take remedial action to protect system reliability and; be set to reliably detect all fault conditions and protect the electrical network from these faults. There are a number of requirements that specify how

protective relays should be set so that they will not limit loadability of a circuit. One of the requirements of the Standard (R6) is for the Planning Coordinator to determine the facilities that must comply with requirements R1 through R5 of NERC standard PRC-023.

In accordance with Attachment B of PRC-023, the following circuits are subject to Requirement R6:

- Transmission lines operated at 100 kV to 200 kV and transformers with low voltage terminals connected at 100 kV to 200 kV, except Elements that connect the GSU transformer(s) to the Transmission system that are used exclusively to export energy directly from a BES generating unit or generating plant. Elements may also supply generating plant loads.
- Transmission lines operated below 100kV and transformers with low voltage terminals connected below 100 kV that are part of the BES, except Elements that connect the GSU transformer(s) to the Transmission system that are used exclusively to export energy directly from a BES generating unit or generating plant. Elements may also supply generating plant loads.

Process to determine PRC-023 Critical Facilities

PJM staff will conduct an assessment at least once each calendar year, with no more than 15 months between assessments applying the criteria in accordance with Attachment B or PRC-023 to determine the circuits for which Transmission Owners, Generator Owners, and Distribution Providers must comply with Requirements R1 through R5. PJM will maintain a list of circuits subject to PRC-023 per application of Attachment B and provide the list of circuits to all Regional Entities, Reliability Coordinators, Transmission Owners, Generator Owners, and Distribution Providers within its Planning Coordinator area within 30 calendar days of the establishment of the initial list and within 30 days of any changes to that list. The test will monitor all required facilities in accordance with Attachment B of PRC-023 as described below.

NERC Standard PRC-023 Transmission Relay Loadability - Attachment B

If any of the following criteria apply to a circuit, the applicable entity must comply with the standard for that circuit.

- The circuit is a monitored Facility of a permanent flowgate in the Eastern Interconnection, a major transfer path within the Western Interconnection as defined by the Regional Entity, or a comparable monitored Facility in the Québec Interconnection, that has been included to address reliability concerns for loading of that circuit, as confirmed by the applicable Planning Coordinator.
- The circuit is a monitored Facility of an IROL, where the IROL was determined in the planning horizon pursuant to FAC-010.
- The circuit forms a path (as agreed to by the Generator Operator and the transmission entity) to supply off-site power to a nuclear plant as established in the Nuclear Plant Interface Requirements (NPIRs) pursuant to NUC-001.
- The circuit is identified through the following sequence of power flow analyses performed by the Planning Coordinator for the one-to-five-year planning horizon o

Simulate double contingency combinations selected by engineering judgment, without manual system adjustments in between the two contingencies (reflects a situation where a System Operator may not have time between the two contingencies to make appropriate system adjustments).

- o For circuits operated between 100 kV and 200 kV evaluate the post-contingency loading, in consultation with the Facility owner, against a threshold based on the Facility Rating assigned for that circuit and used in the power flow case by the Planning Coordinator.
- o When more than one Facility Rating for that circuit is available in the power flow case, the threshold for selection will be based on the Facility Rating for the loading duration nearest four hours.
- o The threshold for selection of the circuit will vary based on the loading duration assumed in the development of the Facility Rating.
- If the Facility Rating is based on a loading duration of up to and including four hours, the circuit must comply with the standard if the loading exceeds 115% of the Facility Rating.
- If the Facility Rating is based on a loading duration greater than four and up to and including eight hours, the circuit must comply with the standard if the loading exceeds 120% of the Facility Rating.
- If the Facility Rating is based on a loading duration of greater than eight hours, the circuit must comply with the standard if the loading exceeds 130% of the Facility Rating.
 - o The Radially operated circuits serving only load are excluded.
- The circuit is selected by the Planning Coordinator based on technical studies or assessments, other than those specified in the NERC Standard PRC-023 Transmission Relay Loadability - Attachment B Criteria above, in consultation with the Facility Owner
- The circuit is mutually agreed upon for inclusion by the Planning Coordinator and the Facility owner.

G.11 PJM Capacity Import Limit Calculation Procedure

Introduction

- The purpose of PJM Capacity Import Limit Calculation Procedure is to establish the amount of power that can be reliably transferred to PJM from defined regions external to PJM.
- The PJM Capacity Import Limit is calculated annually and is used to confirm that import capability into the PJM system is greater than the sum of the PJM Capacity Benefit Margin (CBM) and confirmed Long Term Firm Transmission Service. The imports into PJM will therefore be comprised of firm transmission service reservations and non-firm energy purchases from the external supply regions described in section 3 below.

General Procedures and Assumptions

The system power flow model will be based on the latest summer peak RTEP base case.

- The base case will contain confirmed Long Term Firm Transmission Service for the study period as identified in the PJM OASIS.-.
- The PJM dispatch will reflect a PJM generation deficiency situation independent of the defined regions external to PJM. Thus, non-PJM regions are operating normally and are assumed to be able to supply PJM with power up to the lower of the Capacity Import Limit or the limit of their available reserves. Load in PJM and all external regions will be modeled at a 50/50 load level and load. The amount of reserves considered available from any adjacent non-PJM area may be adjusted to reflect historical data and expected future conditions.
- For thermal analyses, all Eastern Interconnection BES facilities (100 kV and above) will be monitored. All PJM internal BES single contingency events and selected non-PJM BES contingency events will be considered.
- For voltage analyses, all PJM BES facility voltage magnitude and drop limits will be monitored and selected non-PJM BES facility voltage limits will be observed. In addition, any part of the Eastern Interconnection that would experience voltage collapse will be evaluated. The voltage analyses are subject to all PJM internal BES single contingency events and selected non-PJM BES contingency events.
- The following operating procedures will be employed as necessary.
 - o Adjustments of Phase Angle Regulators (PARS which PJM or PJM member companies control (within existing agreements for emergency operation). For the PJM/NYISO PARs in particular, flows will be set according to the ratios provided in Attachment B Section (B.3) (VII) (P), but be based on both the firm and any non-firm emergency assistance from NYISO.
 - o The activation of any approved PJM or PJM member company operating procedure (procedure descriptions are available in Manual 3.)
- The activation of any approved PJM or PJM member company operating procedure (procedure descriptions are available in Manual 3.)
 - o Redispatch and implementation of load management schemes will not be considered as part of this study.
- Methodology
 - o The external supply will come from those regions within the Eastern Interconnection that are considered as part of the PJM Reserve Requirement Study. These external supply regions will be divided into five zones for the purpose of determining both a simultaneous import limit and five directional non-simultaneous import limits. During the simulation of the simultaneous limit, the amount of power from each source zone will be optimized. The five zones are:
 - Northern Zone: NYISO & ISO NE
 - Western Tier 1 Zone: MISO East and MISO West

- Western Tier 2 Zone: MISO Central & MISO South
- Southern Tier 1 Zone: TVA & LGEE
- Southern Tier 2 Zone: VACAR (non-PJM)
- These zones may be periodically modified based on changing system patterns or historical operational data.

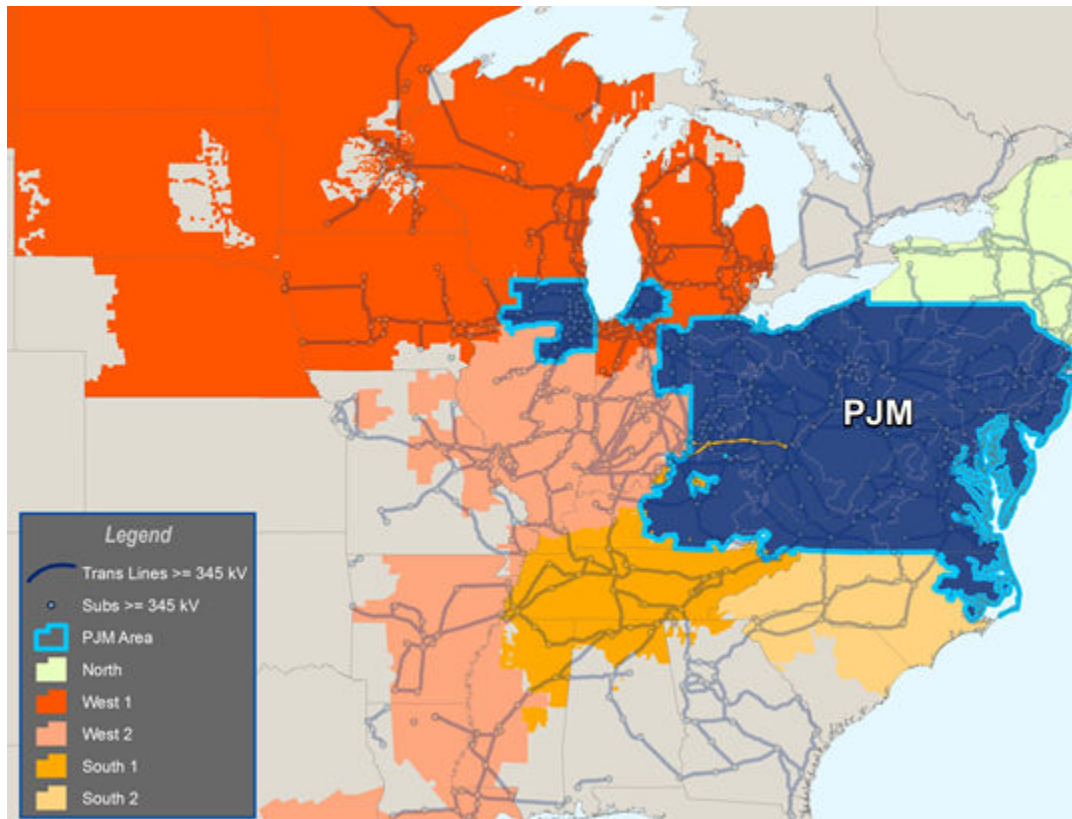

- PJM will scale the load uniformly down at a constant power factor in the external supply zone(s) and scale PJM generation (MW) down uniformly to simulate the power imported from external resources.
- In order to exclude transmission facilities from the monitored list which are not significantly affected by the increase in import power from the external resources, PJM will employ an outage transfer distribution factor cutoff of 3% based on the external zone(s) supplying the resources.
- The aggregate power transfer into PJM, at the point where any increase in this MW transfer would result in a reliability criteria violation, less the applicable PJM Capacity Benefit Margin (CBM) will be defined as the simultaneous PJM Capacity Import Limit.
- Similar approach will be employed to determine the maximum power transfer from any one of the five defined zones into PJM. For determining the non-simultaneous limits, a portion of the CBM will be allocated to each of the five directional transfer paths in

proportion to the ratio of their transfer amount divided by the simultaneous Capacity Import Limit plus the PJM CBM.

Attachment H: Power System Modeling Data

H.1 Power System Modeling Data

Accurate power system modeling data is a key component of quality power system analysis. PJM System Planning uses a variety of models and analytical techniques to create and maintain the simulation models used for the RTEP studies. The intended use of this Attachment is to supplement existing documentation by PJM and other entities that specify accurate modeling data requirements. PJM will continue to follow the data guidelines and standards set forth by NERC as part of the MOD standards and the Eastern Interconnection Reliability Assessment Group (ERAG) Multiregional Modeling Working Group (MMWG) Procedural Manual.

Attachment J contains the checklist for the new equipment energization process to be utilized by Transmission Owners and Designated Entities from inception to energization of upgrade projects.

H.1.1 Load Flow Analysis Models

Base case creation is a collaborative process between PJM and its members. From a technical standpoint PJM follows the guidelines set forth in the ERAG MMWG Procedural Manual. In the following sections, the logistics and transfer of information between PJM and its members are detailed.

Annual Updates

In the late third quarter of each year, PJM will ask Transmission Owners to review and update base case and project files in Model on Demand. The base case updates will include committing case corrections along with in service projects with as built data to the base case. Project files will be updated for status, scope change, and in service date change. PJM will then use Model On Demand to build trial 1 cases for +5 year Summer, Light Load, and Winter, which will be sent to Transmission Owners for review. Transmission Owners will provide:

- Network updates to the model that will advance the case to represent a current year + 5 base case with respect to the 1st Quarter of the following year. This update should be reviewed for correctness and compatibility with the final version of the base case under development
- Complete NERC P1, P2, P3, P4, P5, P6 and P7 contingency file updates that correspond to the updated network model (Include any contingencies which may not change the powerflow model, but change contingency definitions)
- Maximum credible disturbance (NERC TPL-001-4 Table 1 Extreme Events) contingencies
- Any other significant changes such as new load or block load additions
- Support, if necessary, for the development of network models for additional years and demand levels for both near term (years 1 through 5) and longer term (beyond 5 years) analyses.

- Verification that all baseline, network and supplemental upgrades are included in the updated case along with a written description of any case modifications.
- Notification of any changes to tie lines whether they are ties internal to PJM or to external companies.

Interim Updates and Communication of Significant Modeling Updates

In the event that PJM makes a major update to the RTEP analysis models outside of the annual model update window, PJM will notify PJM Transmission Owners of the modeling update through the Transmission Expansion Advisory Committee (TEAC) meetings. Also,

PJM will notify neighboring entities that PJM determines may be impacted. In addition to the notification, PJM will make the updated affected models available upon request.

Generation Owner Requirements:

- Specific information regarding generator capability per MOD-032

H.1.2 Load Flow Modeling Requirements

In addition to the guidelines set forth by NERC and the ERAG MMWG procedural manual, PJM uses several specific procedures in establishing the base case so that it represents the best starting point for the annual RTEP analysis.

Generator step-up transformers

Generator models should represent the physical plant lay-out to the extent possible, explicitly modeling generator step-up transformers (GSUs) and Station Service loads (aka Auxiliary loads). This applies to units above 20 MW and connected to the BES system, consistent with BES requirements. Plants consisting of multiple units aggregating to 75 MW or more also require explicit representation of GSUs and station service loads.

Modeling of Outages

Known outages of Generation or Transmission Facilities with a duration of at least six months will be included under those system peak or off-peak conditions in the appropriate base case model. PJM may not model these outages in every case that is used for RTEP analysis, but will select appropriate scenarios to assess these changes. Additionally PJM will analyze a subset of maintenance outages submitted through eDart under those system peak or off-peak conditions.

Interchange

The PJM net interchange in the summer peak case is determined by the firm interchanges that are represented in the PJM OASIS system. That interchange, in the summer peak case, shall be represented as 100% of the confirmed full path (must be confirmed in both PJM and external zone OASIS) firm import and export reservations. Reservations associated with individual generation units, or group of units at a facility, shall be used in representing the interchange. The interchange in light load cases follows the light load criteria as defined in the Light Load Reliability Analysis in section 2.3.10 of this manual.

Generator Reactive Capability

Annually, PJM updates the model for the generator reactive capability (GCAP) of each generator based on data used by PJM Operations, which includes default limits obtained from the most up to date d-curves as well as data provided by the Generator Owners.

Interconnection Projects With Final Agreements

PJM includes queue projects with a signed final agreement into the base case as well as verifying the accuracy of queue projects that have not yet signed a final agreement. PJM also includes the interconnection, ratings and associated upgrades for each of these projects. Transmission Owners will verify the accuracy of the points of interconnection and the associated upgrades in their zones.

Real and Reactive Load

Each TO is responsible for modeling the active (real) and reactive load profile in its zone. PJM will scale the load in each zone to the targeted values reported in the latest annual PJM load forecast report.

Real loads will be scaled uniformly in each zone to meet the PJM 50/50 load forecast less any Demand Response (DR), or Behind the Meter (BTM) generation as necessary. Real loads will also be scaled uniformly within each zone for off-peak analysis. Reactive load in each area will be scaled at a constant power factor along with the real load for peak load analysis. For off-peak analysis including light-load, PJM will provide a case to the Transmission Owners, at their discretion, for updating their zonal reactive load profile.

Any deviation from the above method of load modeling method, associated with specific test procedures such as the PJM Load Deliverability Procedure or the PJM Light Load Reliability Test Procedure will be defined specifically in other sections of this manual.

PJM will coordinate with TOs on an individual basis to ensure that non-conforming loads are properly modeled and not uniformly scaled. Voltage Schedules

The setting of voltage schedules is crucial to the robustness of cases. PJM allows Transmission Owners to supply generator voltage schedule data. If the data is not provided PJM will use the default voltage schedules as defined in PJM Manual 03.

H.1.3 Submittal of Load Flow Data

Attachment J contains the checklist for the new equipment energization process to be utilized by Transmission Owners and Designated Entities from inception to energization of upgrade projects.

Acceptable Data Formats

PJM sanctioned software:

- PSS/E – power flow modeling software
- TARA – steady state power flow analysis tool

For PSS/E users, cases should be submitted to PJM in a “.SAV” format in a PSS/E version that is readable by the current version of PSS/E that MMWG is using.

For users of PSLF or other modeling software, cases shall be submitted to PJM in a “.RAW” format that is PSS/E compatible and is readable by the current version of PSS/E that MMWG is using.

PJM’s migration of PSS/E versions may slightly lag MMWG, in that case it is acceptable to provide updates formatted for the current version that PJM is using.

TO’s can submit data in an agreed to version if they are unable to export to the latest MMWG compatible version.

Timing

Transmission Owners must comply with the schedule dictating the timeliness of the case creation process which will be included in the initial email sent to kick off the process. This schedule will include a minimum of 4 weeks to provide updates to the case and corresponding files for the first iteration, and 2 weeks for the second iteration. Load Flow Data Quality

In the event that data provided by Transmission Owners does not pass all of the testing included in the MMWG data checker, PJM may request updated data.

Transmission Owners must provide unique bus names or circuit ID’s for each winding of all transformers.

Bus numbers must be within the allocated bus number range for each company.

Conventions used for the naming of Machine ID’s vary for different TO zones. PJM will coordinate with each TO individually to align with their preferred convention.

Certain specific modeling and naming conventions which must be followed by all TO’s include:

- High/Low Pressure units should be modeled on the same bus and designated with the corresponding machine ID “H” and “L”.
- No other machine ID should be named “H” or “L”.

With the exception of High/Low Pressure units, multiple machines modeled on the same bus must have the same status. Offline machines should not be modeled on the same bus as machines which have a status of online.

Machines at the same plant with different statuses should be modeled on separate busses connected by a very low impedance line ($X=.002$) as defined in the MMWG manual.

H.1.4 Short Circuit Analysis Models

Short Circuit data procedures are documented in the Attachment G.7 of this manual, which references ANSI/IEEE 551. The intended use of this attachment is to supplement these procedures and outline the data requirements which PJM follows in creating the short circuit cases used for analysis.

Short circuit models should be provided in Aspen “.olr” format, if possible.

Each TO provided Aspen “.OLR” case should model only the TO area and its tie lines. No outside areas should be included in the submission.

All area numbers in the TO provided cases should be consistent with MMWG designated area numbering convention. Area numbers such as 1, 2, 3, etc. are not acceptable.

Generation owners must submit to PJM all their breaker data for breakers rated above 100 kV.

Transmission Owners must submit an excel sheet containing explanations for outaged and out-of-service equipment that is normally in-service.

Timing

In the 1st quarter of each year, PJM will send the Transmission Owners an initial current year +5 impedance network model. This case is based on the most up to date PJM short circuit case combined with the previous year's RTEP case containing all upgrades, MTX projects, and generation queue projects in the Facility Studies Phase that have been identified during that RTEP cycle.

In the 4th quarter of each year, PJM will send the Transmission Owners an initial current year +2 impedance network model. This case is based on the most up to date PJM short circuit case combined with the previous year's RTEP case containing all upgrades, MTX projects, and generation queue projects in the Facility Studies Phase that have been identified during that RTEP cycle.

Transmission Owners must comply with the time schedule of the case creation process which will be included in the initial email sent to kick off the process. This schedule will include a minimum of 4 weeks to provide updates to the case and corresponding files. Once all cases and corresponding files have been submitted to PJM, a +2 case is created and analysis performed to determine overdutied breakers. TOs are then given another 4 weeks to confirm any new overdutied breakers. After the +2 year short circuit case is finalized, the +2 year case is then used to create the +5 year short circuit case for performing the short circuit studies and identifying the new system issues. The identified issues will be sent out to the Transmission Owners who will have 4 weeks to provide solutions to address these issues.

H.1.5 Stability Analysis Models

The case used for stability and dynamic studies is developed by PJM based on information from the Regional Transmission Expansion Plan (RTEP) case prepared by PJM Interconnection and the MMWG case prepared by Powertech Labs for the Eastern Interconnection Reliability Assessment Group (ERAG).

When preparing the base case for stability and dynamics, the ERAG case provides the information for the areas outside PJM while the RTEP case provides the PJM information (e.g. load forecast, network configuration). When combining the ERAG and the RTEP cases, care should be taken to preserve the ties between the PJM areas and the rest of the Eastern Interconnection.

All generator projects active in the PJM queue process that have been studied must be included in the base case for stability and dynamics. In some instances, the RTEP model for the queue project may not be detailed enough for use in stability studies. In this situation, the case must be updated to make sure that all detailed components associated with this project are included in the stability and dynamics power flow model (e.g. generator step-up transformer, loads).

In addition to updating the power flow case with the latest network information, the dynamic models must also be updated to reflect the changes introduced by the RTEP case and the stability and dynamic studies performed by PJM. In this regard, the dynamic data file from the ERAG MMWG case is updated so that the dynamic models for the generators in the PJM areas

are matched against the new power flow information from the RTEP. The dynamic model for each queue generator must also be added to the dynamic data file.

The resulting power flow case, the dynamic data file and supporting files required for a complete stability and dynamics base case need also to be correlated and reviewed to determine inconsistencies as well as missing or questionable data. A base case is considered to be finished when, after the review, it compiles, links the models to the PSS/E main structure and initializes correctly. An acceptable condition for a finished base case is when simulated system dynamics, using this case, do not deviate from the initial conditions for any simulation setup with no disturbances applied to the system.

Timing

In the first half of each year, PJM will build stability cases based on updated previous year RTEP power flow model and the latest ERAG dynamic cases. In this period, PJM may request the Transmission Owners for load models for dynamic studies, and for other supporting data if necessary. Transmission Owners must comply with the time schedule of the stability case creation process which will be included in the request email.

Stability and dynamics base cases:

- Stability is assessed using a summer peak load and a light load condition. The summer peak stability case has the load profile of the RTEP summer peak case and corresponds to the demand expected to be served in the specific planning year. The light load stability case represents 50% of the summer peak load and is developed by scaling down the summer peak load case at the same power factor.
- For simplicity, it is recommended to first build the summer peak case and then update that case to reflect the second load condition (light load). This approach provides two cases that are common in bus numbers and network information. Updates to both cases, such as addition or removal of proposed lines or queue projects would be easy to handle due to the uniformity.

After the power flow case has been finalized and revised, the dynamic data file from the dynamic data file will be updated to reflect the changes that were introduced by the addition of the PJM areas from the RTEP case and generation interconnection studies. It is important to note that the RTEP case and the ERAG case complement each other. RTEP case information is used for future generation queue projects and transmission upgrades which don't exist in the ERAG case and ERAG case consists of information of existing units.

The light load case (50% peak) is derived from the summer peak case. This approach ensures consistent bus numbers and network information in both cases, making addition or removal of proposed lines or queue projects easy to handle. After the summer peak case is completed, the PJM load is scaled down to a load representing 50% of the 50/50 load. The areas outside PJM are updated with the light load case from the corresponding ERAG MMWG case. Note that generation and shunt capacitors may be turned off or disabled in order to achieve convergence of the power flow. In addition, all pumped storage hydro units are modeled in the pumping mode with their governors and power systems stabilizers deactivated or adjusted to reflect the appropriate operating condition.

Generation/Transmission Owner Responsibilities:

- Provide necessary supporting data for stability case build upon PJM's request including but not limited to: topology information and dynamic modeling and station loads
- Provide station loads, including power factors and load representation data (CONL file) if the load representation is different from the one in the ERAG MMWG series
- Verify upgrades and generator modeling (MVA base & Topology)

If there is any discrepancy between the RTEP case and the ERAG MMWG case for existing units, PJM will follow up with the Generation owner with assistance from the TO to insure that the most current data is used.

A complete base case (summer peak or light load) must include at least:

- A power flow file: This file contains the network information and provides the initial conditions for the dynamic models.
- A dynamic data file: This file contains all the information necessary to simulate the dynamic response of the various system components.
- A gnet file: This file contains the information of those generators that do not have a dynamic model. Any generator listed in this file is considered as a negative MVA load.
- A conl file: This file indicates how loads will be modeled based on a combination of constant MVA, constant current and constant admittance. It is strongly recommended that each TO develop more accurate load representation for stability and dynamics studies

Dynamics Data Submittal Requirements and Guidelines:

The Multiregional Modeling Working Group (MMWG) provides the following topics pertaining to dynamics data submittal requirements and guidelines. This information is accessible in Appendix II of the MMWG Procedure Manual V5. A hyperlink to the manual is located at the bottom of this section.

- Power Flow Modeling Requirements
- Bus name identifiers for synchronous condensers, Static VAR Compensators (SVCs) modeled as generators, switched shunts, relays, and HVDC terminals.
- Step-up transformer representation requirements for both MMWG power flow cases and non-MMWG power flow cases.
- Resistance and reactance data placements for step-up transformers represented in the power flow generator data records.
- Xsource value representations in the power flow generator data record.
- SVC representation requirements in power flows.
- Dynamic Modeling Requirements
- Synchronous generator and condenser modeling / associated data requirements and exceptions.
- Additional representation requirements and exceptions for synchronous generators and condensers modeled as described in Requirement II.1.

- PSS/E modeling requirements for any other types of generating units and dynamic devices.
- Exceptions to the use of standard PSS/E dynamic models.
- Required written documentation and its submittal procedures for user-defined modeling in MMWG cases.
- Generating unit, synchronous condenser, and other dynamic device requirements for netting.
- Lumping conditions of similar or identical generating units at a plant.
- Location requirements for per unit data.
- Exception procedure for any requirements listed.
- Dynamics Data Validation Requirements
- Dynamics data screening requirements
- Preliminary procedures to undergo before regional data submittal to the MMWG coordinator.
- Material required by each region to validate the dynamics model.
- Guidelines
- Additional documentation that should be submitted with dynamics data.
- Information pertaining to parameters for representing loads via the PTI PSS/E CONL activity that the regions should provide to the MMWG.

Location of MMWG Procedural Manual:

https://rfirst.org/ProgramAreas/ESP/ERAG/MMWG/ERAG%20%20MMWG%20Library/MMWG_Procedural_Manual_V29.pdf

Attachment I: Steady State & Stability Performance Planning Events

I.1 NERC TPL-001-4 Table 1

Manual or automatic load shed is not permitted for any P0 - P7 condition.

NERC TPL-001 Events (excludes DC)				PJM		
NERC Category	Initial Condition	Event ¹	Fault Type ²	Thermal Limits	Low Voltage Limit **	High Voltage Limit **
P0 No Contingency	Normal System	None	N/A	Apply normal limits, the actual % may differ, depending on the TO zone	PJM Planning will use the same voltage limits that are used in PJM Operations for both voltage magnitude and voltage deviation. Emergency limits are used for normal, single contingencies and multiple contingencies. For Transmission Owner Criteria, PJM will default to the operations limits unless the TO limits are more conservative.	
P1 Single Contingency	Normal System	Loss of one of the following: 1. Generator 2. Transmission Circuit 3. Transformer ⁵ 4. Shunt Device ⁶	3Ø	Apply emergency limits, the actual % may differ, depending on the TO zone		
P2 Single Contingency	Normal System	1. Opening of a line section w/o a fault ⁷ 2. Bus Section Fault 3. Internal Breaker Fault ⁸ (non-Bus-tie Breaker) 4. Internal Breaker	N/A SLG SLG SLG			

NERC TPL-001 Events (excludes DC)				PJM		
NERC Category	Initial Condition	Event ¹	Fault Type ²	Thermal Limits	Low Voltage Limit **	High Voltage Limit **
		Fault ⁸ (Bustie Breaker)				
P3 Multiple Contingency	Loss of generator unit followed by System adjustments ⁹	Loss of one of the following: 1. Generator 2. Transmission Circuit 3. Transformer ⁵ 4. Shunt Device ⁶	3Ø	Normal limits after the 1st contingency, emergency limits after the second contingency.		

<p>P4 Multiple Contingency <i>(Fault plus stuck breaker)¹⁰</i></p>	<p>Normal System</p>	<p>Loss of multiple elements caused by a stuck breaker¹⁰ (non-Bus-tie Breaker) attempting to clear a Fault on one of the following:</p> <ol style="list-style-type: none"> 1. Generator 2. Transmission Circuit 3. Transformer 4. ShuntDevice⁶ 5. Bus Section 	<p>SLG</p>	<p>Apply emergency limits, the actual % may differ, depending on the TO zone</p>	
--	----------------------	--	------------	--	--

NERC TPL-001 Events (excludes DC)				PJM		
NERC Category	Initial Condition	Event ¹	Fault Type ²	Thermal Limits	Low Voltage Limit **	High Voltage Limit **
<p>P5 Multiple Contingency <i>(Fault plus relay failure to operate)</i></p>	<p>Normal System</p>	<p>Delayed Fault Clearing due to the failure of a nonredundant relay¹³ protecting the Faulted element to operate as designed, for one of the following:</p>	<p>SLG</p>			

		<ol style="list-style-type: none"> 1. Generator 2. Transmission Circuit 3. Transformer⁵ 4. ShuntDevice⁶ 5. Bus Section 			
P6 Multiple Contingency (Two overlapping singles)	Loss of one of the following followed by System adjustments ⁹ <ol style="list-style-type: none"> 1. Transmission Circuit 2. Transformer⁵ 	Loss of one of the following: <ol style="list-style-type: none"> 1. Transmission Circuit 2. Transformer⁵ 3. Shunt Device⁶ 	3Ø	Apply emergency limits, the actual % may differ, depending on the TO zone	

NERC TPL-001 Events (excludes DC)				PJM		
NERC Category	Initial Condition	Event ¹	Fault Type ²	Thermal Limits	Low Voltage Limit **	High Voltage Limit **
	<ol style="list-style-type: none"> 3. ShuntDevice⁶ 4. Single pole of a DC line 					

P7 Multiple Contingency <i>(Common Structure)</i>	Normal System	The loss of any two adjacent (vertically or horizontally) circuits on common structure ¹¹	SLG		
--	---------------	--	-----	--	--

Note:

(*please note that footnotes 3, 4 and 12 have been intentionally skipped to preserve alignment with subsequent footnote numbering.)

1. If the event analyzed involves BES elements at multiple System voltage levels, the lowest System voltage level of the element(s) removed for the analyzed event determines the stated performance criteria regarding allowances for interruptions of Firm Transmission Service and Non-Consequential Load Loss.
2. Unless specified otherwise, simulate Normal Clearing of faults. Single line to ground (SLG) or three-phase (3 \emptyset) are the fault types that must be evaluated in Stability simulations for the event described. A 3 \emptyset or a double line to ground fault study indicating the criteria are being met is sufficient evidence that a SLG condition would also meet the criteria.
5. For non-generator step up transformer outage events, the reference voltage, as used in footnote 1, applies to the low-sidewinding (excluding tertiary windings). For generator and Generator Step Up transformer outage events the reference voltage applies to the BES connected voltage (high-side of the Generator Step Up transformer). Requirements which are applicable to transformers also apply to variable frequency transformers and phase shifting transformers.
6. Requirements which are applicable to shunt devices also apply to FACTS devices that are connected to ground.
7. Opening one end of a line section without a fault on a normally networked Transmission circuit such that the line is possibly serving Load radial from a single source point.
8. An internal breaker fault means a breaker failing internally, thus creating a System fault which must be cleared by protection on both sides of the breaker.
9. An objective of the planning process should be to minimize the likelihood and magnitude of interruption of Firm Transmission Service following Contingency events. Curtailment of Firm Transmission Service is allowed both as a System adjustment (as identified in the column entitled 'Initial Condition') and a corrective action when achieved through the appropriate redispatch of resources obligated to re-dispatch, where it can be demonstrated that Facilities, internal and external to the Transmission Planner's planning region, remain within applicable Facility Ratings and the re-dispatch does not result in any Non Consequential Load Loss. Where limited options for re-dispatch exist, sensitivities associated with the availability of those resources should be considered.
10. A stuck breaker means that for a gang-operated breaker, all three phases of the breaker have remained closed. For an independent pole operated (IPO) or an independent pole tripping (IPT) breaker, only one pole is assumed to remain closed. A stuck breaker results in Delayed Fault Clearing.
11. Excludes circuits that share a common structure (Planning event P7, Extreme event steady state 2a) or common Right-of-Way (Extreme event, steady state 2b) for 1 mile or less.
13. Applies to the following relay functions or types: pilot (#85), distance (#21), differential (#87), current (#50, 51, and 67), voltage (#27 & 59), directional (#32, & 67), and tripping (#86, & 94).

Attachment J: Checklist for New Equipment Energization Process

The following checklist has been created for use by Transmission Owners and Designated Entities as a guideline for what is required by PJM throughout the baseline/supplemental transmission upgrade process from inception to energization.

For more detailed information please refer to the training series: Transmission Planning, Modeling, and Energization which can be accessed from any of the following pages on [pjm.com](http://www.pjm.com):

<http://www.pjm.com/planning/rtep-development.aspx>;

<http://www.pjm.com/planning/rtep-development/powerflow-cases.aspx>

<http://www.pjm.com/planning/design-engineering.aspx>; <http://www.pjm.com/markets-and-operations/ops-analysis.aspx>

Project Phase ¹	Task	Delivery	Timeframe	PJM Manual Reference	PJM Contact Department	Comments
P	Submit minimum required rating (lines and xfmrs)	Email to contact	Before Project Approval	M-14B	Transmission Planning	
P	Submit planning model parameters	IDEV/ Project File	Before Project Approval	M-14B	System Planning Modeling and Support	
P	Submit planning contingency changes	CON File	Before Project Approval	M-14B	Transmission Planning	
P	Submit breaker diagrams	Email to contact	Before Project Approval	M-14B	Transmission Planning	
P	Project Description/ Cost/Time Estimate	Email to contact	Before Project Approval	M-14B	Transmission Planning	
EP	Construction Schedule/ Project Sequence	Email to contact	6-8 months prior to UC phase	M-14C	Infrastructure Coordination	

Project Phase ¹	Task	Delivery	Timeframe	PJM Manual Reference	PJM Contact Department	Comments
EP	Submit projected outage timeframes	Email to contact	6-8 months prior to UC phase	M-14C	Infrastructure Coordination	
UC	Quarterly updates	Email to contact	Throughout UC phase	M-14C	Infrastructure Coordination	
EP/UC	Submit as built impedance and all other applicable equipment parameters (i.e. Tap Settings, Capacitor Size etc.)	eDART – Network Model Ticket	6-12 months prior to IS	M-03A; 3.2	Model Management	
EP/UC	Submit final In-Service Date	eDART – Network Model Ticket	6-12 months prior to IS	M-03A; 3.2	Model Management	
EP/UC	Submit target build date	eDART – Network Model Ticket	6-12 months prior to IS	M-03A; 3.2	Model Management	
EP/UC	Submit equipment names	eDART – Network Model Ticket	6-12 months prior to IS	M-03A; 3.2	Model Management	
EP/UC	Submit final one-line diagrams	eDART – Network Model Ticket	6-12 months prior to IS	M-03A; 3.2	Model Management	

EP/UC	Submit Transmission Outage Tickets	eDART	2-12 months prior to IS	M-03; 4.2	Transmission Operations	
EP/UC	Submit Ratings (Lines	eDART – TERM	No later than 2	M-03A; 3.2	Real-Time Data Management TERMTickets@pjm.com	
Project Phase¹	Task	Delivery	Timeframe	PJM Manual Reference	PJM Contact Department	Comments
	and Transformers)		weeks prior to IS			
EP/UC	Submit Telemetry	Email	No later than 2 weeks prior to IS	M-03A; 3.2	Real-Time Data Management PJMTelemetrySupport@pjm.com	
EP/UC	Submit As built data	Project File	IS Date	M14B	System Planning Modeling and Support	
UC/IS	Notification of In-Service status	Email	Once facility is energized	M-14C	Infrastructure Coordination	

¹Key: **P** = Pending (or before Pending), **EP** = Engineering and Procurement, **UC** = Under Construction, **IS** = In-Service

Note:

For maximum exposure to various members, identical copies of this table can be found in PJM Manuals 03A, 14B, and 14C

Revision History

Administrative Change (01/21/2022):

- Updated manual ownership from Aaron Berner to Sami Abdulsalam

Revision 51 (12/15/2021):

- Changes to grammar in 1.3.2 Economic Planning
- Added a new subsection 1.4.2.4 Incorporation of EOL Needs into the RTEP
- Added new language detailing analysis in 2.1.2 Reliability Planning
- Added new graphics in 2.2.1 Reliability Planning
- Updated language to include Winter Peak Cases in 2.3.8 NERC P3 and P6 “N-1-1” Analysis
- Changed the title of subsection 2.3.15 to Extreme Event Review
- Added new objectives in 2.6 RTEP Market Efficiency Planning
- Added language in the following Attachments
 - o B.2 and B.3
 - o C.2.6
 - o D.1
 - o F
 - o G.9.2 and G.9.6
 - o H.1.2 and H.1.3

Revision 50 (07/01/2021):

- Added a new subsection 1.4.1.8 Maintaining reliability associated with critical substations
- Added a new bullet in section 2.1 Transmission Planning
- Added a new section 2.9 Critical Substation Planning Analysis

Revision 49 (06/23/2021):

- Changes to section 2.6 RTEP Market Efficiency Planning
 - o Added Reliability Pricing Model constraints to the list of constraints that have an economic impact.
 - o Inserted new subsection 2.6.5.2 Determination of Reliability Pricing Model (RPM) Benefits in section 2.6.5 Determination of Market Benefits - RPM benefits are determined using RPM simulations for the RPM and RTEP years.
- Attachment E: Market Efficiency Analysis Economic Benefit / Cost Ratio Threshold Test
 - o Updated obsolete language regarding the 15 year period used for the B/C ratio to conform to the B/C ratio changes, PJM OA Section 1.5.7, accepted by FERC Order Docket No. ER19-80-001) (Issued 2019-02-19)

Revision 48 (10/01/2020):

- Add metering systems to section B.3 Procedure RTEP Deliverables third Bullet

Revision 47 (09/01/2020):

- Updated sections G.3, G.4 and G.5 to incorporate the FERC Order 845 Second Compliance Filing Tariff changes.
- Clarified that stability analysis will be performed during the Facilities Study

Revision 46 (08/28/2019):

- Changes to section 2.6.8 Market Efficiency project reevaluation process

Revision 45 (08/22/2019):

- Conform changes for context and alignment of terms (multiple locations)
- Update links for PJM.com
- Section 1.1, 1.3.4:
 - o Provide additional clarity as to the process of integrating Supplemental Projects in the RTEP
- Section 1.3: o Define the applicability of modeling requirements associated with the RTEP
- Section 1.4: o Update outline numbering
 - o Conform discussions for Customer Funded Upgrades to the definitions and processes from the Tariff
- Section 1.4.2: o Clarify how overlapping needs are addressed in the RTEP
- Section 1.4.3:
 - o Provide information as to the process used for the removal of projects from the RTEP under various conditions

Revision 44 (02/21/2019)

- Cover to Cover Periodic Review
- Revision to Section 1A on CEII
- Updated Attachment C
 - o Various updates for clarity and alignment with current processes
 - o Section C.2
 - Added language that non-radial facilities 345 kV and up will only automatically be considered as CETL limits for an LDA if they have greater than a 2% OTDF
 - Clarified that PJM may choose to include specific non-PJM transmission facilities in the load deliverability test in order to account for significant loop flows

- Removed sentence that states that Load Deliverability Facility List will be locked down prior to each baseline
- New procedure added to require both thermal and voltage analysis on both Discrete Outage Case and Mean Dispatch Case
- Procedure modified to examine mean thermal loadings instead of median thermal loadings

Revision 43 (01/24/2019):

- Revise Section 1 and 2 to incorporate references to the Open Access Transmission Tariff, Attachment M-3 process
- Revise Sections 1 and 2 to include improved discussion of workflow and alignment to current processes

Revision 42 (08/23/2018):

- Updated Section 2.6.5 to include RTEP+15 b/c cap and for benefits adjustments due to in-service year later than RTEP. Also added language to note fixed generation and transmission topology for each simulation year.

Revision 41 (04/19/2018):

- Cover to Cover Periodic Review
- Updated Section 1.3 and Attachment H.1 per NERC MOD requirement standard numbering
- Updated Section 2.3.8 bullet formatting
- Updated Section 2.3.13 by removing language regarding winter temperature ratings sets
- Updated Attachment C.5.3.3 to add OVEC to study area definitions
- Updated Attachment C.7.3 to reference low side of transformer in generator deliverability procedures
- Updated Attachment D.2.2 to correct references to contingency types in table 2 and step 3

Administrative Change (01/31/2018):

- Manual ownership updated from Mark Sims to Aaron Berner

Revision 40 (10/26/2017):

- Updated Section 2.3.5 for bus tie breaker contingencies

Revision 39 (9/28/2017):

- Updates for termination of PJM/NYISO Wheel Agreement

- Updates to Attachment J(New Equipment Energization Checklist) for updated PJM Contact Department
- Updated Attachment G.7 for PJM Short Circuit model build contact

Revision 38 (07/27/2017):

- Removed references to the annual RTEP cycle in order to reflect the new 18-month RTEP cycle.
- Updated Exhibit 1 to also reflect new 18 month cycle.

Revision 37 (4/28/2017):

- Updated baseline thermal analysis section (2.3.6) to reflect correct N-1 analysis process
- Updated SPS to RAS per NERC definition change
- Updated PRC-023-3 to PRC-023 to account for future Standard revisions including PRC-023-4 which goes into effect 4/1/2017
- Updated for removal of EE (Energy Efficiency) References – as they are now included within the load forecast

Revision 36 (11/17/2016):

- Updated Attachment G.11 to reflect changes to Capacity Import Limit test as applicable to Long term Firm Service requests
- Updated hyperlinks throughout document to update for web changes

Administrative Change (10/01/2016):

- Attachment J:
 - o Added hyperlinks for Training Series: Transition Planning, Modeling and Energization
 - o Removed column entitled “Online Training Links”

Revision 35 (10/01/2016):

- Updated Section 2.3.13 and Attachment D-3.2 for ratings used in Winter Analysis
- New Appendix J: Checklist for New Equipment Energization Process and associated references in sections: 1.3.1; B.3; H.1; and H.1.3

Revision 34 (08/09/2016):

- Manual Ownership changed from Paul McGlynn to Mark Sims
- Added new Section 1A - About Critical Energy Infrastructure Information (CEII)
- Administrative Change: Updated Ramping Limits in winter peak study section

Added Required In Service Dates for Light Load Reliability Analysis and Winter Peak Reliability Analysis

- Corrected references to TPL-001-4 in the PJM Planning SOL Methodology Section
- Updated Attachment G.9.6 including compliance language

Revision 33 (05/05/2016):

- Updated to revise Attachment G, Section 9.6.

Revision 32 (01/28/2016):

- Updated Attachment B, C and H for Transmission Service Study Procedures

Revision 31 (12/31/2015):

- Corrected references in C.5.7
- Updates to Section 2.1 for Multi Driver Approach
- Added a Winter Peak Reliability Analysis Criteria
- Updated section 2.7 for the inclusion of Energy Market Uplift
- Updates throughout this manual per TPL-001-4
- Periodic Review

Revision 30 (02/26/2015):

- Updated Section 2.3.13 to add more detail to the Long Term Deliverability Analysis
- Updated Attachment A to include a detailed cost allocation example
- Updated C.7 in Attachment C to add more detail to the Generator Deliverability Procedure
- Added C.8 in Attachment C to add more detail to the Long term Deliverability Analysis
- Updated G.2.2 to clarify the voltage drop test procedure
- Revision 29 (11/21/2014)
- Added “Modeling of Outages” section to Attachment H Section H.1.2
- Updated Section G.10 of Attachment for new version of PRC-023 standard

Revision 28 (08/21/2014):

- Added Section 4.8 to Attachment C for CETO/CETL as an input to RPM
- Updated Section numbering in Attachment C
- Updated Attachment A to reflect the current approved cost allocation methodology as described in the PJM OATT

Revision 27 (4/23/2014):

Updated Attachment E for confirming changes associated with Market Efficiency Analysis and Benefit/Cost test

Revision 26 (3/28/2014):

- Updated Attachment C for changes to the use of commercial probability during the feasibility and impact study phases of the interconnection process
- Updated Attachment H for +2 year short circuit study cleanup
- Corrected typo/incomplete sentence in section G.4.1
- Added Section G.11: PJM Capacity Import Limit Calculation Procedure

Revision 25 (10/24/2013):

- Updated Attachment G.7 (Short Circuit) to a current year +2 short circuit planning representation
- Added confirming changes to Market Efficiency related to two year cycle process and timeline

Revision 24 (06/05/2013):

- Updated Attachment G.10 (PRC-023 – Transmission Relay Loadability)

Revision 23 (03/01/2013):

- Updated the Light Load Reliability Analysis Procedure
- Updated the SOL/IROL Definition in Planning to reflect inclusion of all PJM Markets Monitored facilities in alignment with PJM Operations
- Added Interim Updates and Communication of Significant Modeling Updates to Attachment H: Power System Modeling Data
- Correct typographical errors in section 2.3.3

Revision 22 (10/25/2012):

- Updated Exhibits for Base case development and 24 month cycle
- Addition of EKPC and Cleveland LDA, including Cleveland LDA map

Revision 21 (04/26/2012):

- Revised Generator Deliverability procedure to limit the “Adder” contribution based on an estimated CETO for generation in the receiving end area.

Revision 20 (12/22/2011):

- Added additional detail to the NERC Category C3 “N-1-1” section

- Created NERC Category C3 “N-1-1” stability section
- Added references to DUKE Energy Ohio/Kentucky
Added additional detail to the NERC Standard PRC-023 Transmission Relay Loadability Section
- Updated Section 2 to reflect 24 Month Planning Process
- Fixed two small typos in the alt paragraph on P55 in the C.3 Section

Revision 19 (09/15/2011):

- Added Attachment H Power System Modeling Data

Revision 18 (7/20/2011):

- Added Light Load Reliability Analysis criteria and created a new attachment D-2 to contain the criteria.
- Added description of reactive load modeling in CETL base cases.

Revision 17 (4/13/2011):

- Added references where appropriate to reflect the inclusion of the American Transmission Systems, Inc. (ATSI) and Cleveland Public Power (CPP).
- Clarified the methodology to establish an IROL in the Planning Horizon.
- Updated the short circuit methodology to include the existing process to study all BES breakers.

Revision 16 (11/18/2010):

- Added a Contingency Definitions section (10/20/2010 MRC approval)
- Added Appendix G.10 NERC Standard PRC-023 – Transmission Relay Loadability (10/20/2010 MRC approval)
- Modified PJM Critical Energy Infrastructure Information Release Guidelines (08/05/2010 MRC approval)
- Added clarifying language to Baseline Voltage Analysis test methodology (08/05/2010 MRC approval) Updated the IROL definition to align with the latest NERC IROL definition (08/05/2010 MRC approval)

Revision 15 (04/21/2010):

- Added new Attachment F describing PJM stability, short circuit and special RTEP practices and procedures. This Attachment includes the special requirements for coordination of planning for nuclear interfaces

Revision 14 (02/01/2010):

- Attachment C: Added language to specify how energy efficiency is incorporated into deliverability tests. Added additional language to specify the load level modeled in the load deliverability test for the area being tested. (1/22/10 MRC Approval)

Revision 13 (11/16/2009):

Inserted Commercial Probability technique in Attachment C, Generator Deliverability Procedure Step 5 (10/2/08 MRC approval)

- Added Attachment F: Determination of System Operating Limits for Planning the Bulk Electric System (06/17/09 MRC approval)
- Attachment C: Cap on generation delivery adders (12/21/09 MRC approval)
- Attachment C: Added language to Overview of Deliverability to Load to clarify criteria that may trigger analysis of potential new LDAs (11/11/09 MRC approval)
- Updated hyperlinks throughout the manual
- Temperature correction and clarification to Attachment B Section VII.N.

Revision 12 (08/08/2008):

The following revisions primarily consist of additions, clarifications and reorganization to address FERC Order No. 890 requirements:

- Additions to Section 1 to update, clarify, and expand the RTEP overview.
- Combine old Sections 6 and 2 into an expanded Section 2.
- Move wind, power factor and behind the meter generation material to a reconstituted Section 6
- Include additional reliability planning process and criteria information
- Market Efficiency Process revisions (section 2 and Attachment E) plus additional editorial and consistency changes throughout including Attachments D, E, and G. • Added Exhibit 1 edits to Intro, Sections 1, 2, related attachments
- Multiple passes of CEII revisions.
- Generation Delivery clarifications in Attachment C.
- Removed the final material in Section 2 that is related to Interconnections to Manual 14A and revised the remaining material appropriately for Manual 14B.
- Exhibit 1 update for quarterly queues
- Attachment D criteria clarifications
- Added final RPPWG comments of Nov 30, 2007 meeting, added minor clarifications, and cut material to move to the appropriate generation or transmission interconnection related portions of revised 14A and 14E as to be determined. Sections deleted from here and moved to either 14A or 14E are: (the following attachment designations are according to the previous version Manual 14B lettering)

- Moved Section 3: Generator and Transmission Interconnection Planning Process
 - Generation and Transmission Interconnection Feasibility Study
 - System Impact study
 - Generation and Transmission Interconnection Facilities Study
- Moved Section 4: Small Resource Interconnection Process
- Moved Section 5: Interconnection Service, Construction & Other Service Agreements
- Moved Section 6: Additional Generator Requirements
 - Behind The Meter Generation Projects
 - Generator Power Factor Requirements
 - Wind-Powered Generation Projects
- Moved Attachment A: PJM Generation and Transmission Interconnection Planning Process Flow
- Attachment B: PJM Cost Allocation Procedures
- Moved PART 1: PJM GENERATION AND TRANSMISSION INTERCONNECTION COST ALLOCATION
- Moved Attachment C : PJM Generation and Transmission Interconnection Planning Team Role Diagram
- Moved Attachment F: General Description of Facilities Study Procedure
- Moved Attachment H: Small Generator (10 MW and Below) Technical Requirements and Standard
- Moved Attachment H-1: Small Generator (above 10 MW to 20 MW) Technical Requirements and Standards
- Moved Annex 1: SCADA Requirements by Transmission Owner Region

Revision 11 (10/05/2007):

- The Manual Title has been changed. The RTEP process has evolved over the past 5+ years and so has the scope of Manual 14B. The title of the manual has been changed from "Generation and Transmission Interconnection Planning" to "PJM Regional Planning Process"
- Section 6 and Attachment I have been revised to reflect the implementation of the 15-year horizon component of PJM's Regional Planning Process cycle, including that for market efficiency. These changes are made in accordance with the mmm, dd 2006 FERC approval of PJM's subject Operating Agreement and Open Access Transmission Tariff (OATT) revisions.
- Conforming editorial revisions have been made throughout the remainder of the document.

Revision 10 (03/01/2007):

- Attachment B: Regional Transmission Expansion Plan revised to include steps for reactive planning in the RTEP.
- Revised hyperlinks in Attachment D: PJM Reliability Planning Criteria.
- Attachment H: Small Generator (10 MW and Below) Technical Requirements and Standards replaces former attachment on Small Generators of 2 MW and less.
Attachment H-1: Small Generator (above 10 MW to 20 MW) Technical Requirements and Standards added.
- References to PJM OATT provisions in Sections 2 and 5 are revised to indicate that they are now in the new Part VI of the OATT (along with their former Part IV locations)
- Wording in Section 2 under “Summary of RTEP Process” and again in Attachment E is revised to reflect that generation retirements included in project studies will be those announced as of the date a project enters the project queue.
- Introduction trimmed to eliminate redundant information.
- List of PJM Manuals exhibit removed, with directions given to PJM Web site where all the manuals can be found.
- Revision History permanently moved to the end of the manual.

Revision 09 (06/07/06):

- Manual sections 1 and 2 and Attachment B (Regional Transmission Expansion Plan – Scope and Procedure) are revised to include Probability Risk Analysis (PRA) of Aging Infrastructure as an input to the PJM Region transmission planning process. The timeline in Section 5 is revised to require the Transmission Owner to submit a final invoice to PJM within 120 days after project completion. Attachment B (Regional Transmission Expansion Plan – Scope and Procedure) is also revised to add guidelines for Scenario Planning. Replaced references throughout to “ECAR, MAAC and MAIN” with ReliabilityFirst, the new replacement regional reliability council as of January 1, 2006.
- Revisions were made on the following pages: 8, 10, 12 through 16, 23, 24, 41, 56, 62, 63, 65, 67, 68 and 98.

Revision 08 (01/16/06):

- Section 1 is revised to state that all analyses of Transmission System adequacy are conducted using the load forecast produced annually by PJM. Attachments E and G are revised to state that load is modeled in the RTEP base case used for the Generator Deliverability procedure at a “non-diversified” 50/50 summer peak load level as per the latest load forecast.

Revision 07 (01/04/06):

- Section 2 is revised to add process for “Evaluation of Operational Performance Issues.” Attachment A is revised to clarify the Load Flow Cost Allocation Method and to add the Schedule 12 Cost Allocation process. Attachment C is revised to include references to Dominion and to add Addendum 2 “Common Mode Outage Procedure” to the Generator Deliverability Procedure. Attachment D is revised to include a minimum power factor for system “load”.

Revision 06 (11/21/05):

- Section 2 is revised to indicate that “One RTEP baseline regional plan will be developed and approved each year” and that “Generation retirements will not affect the study

results” for any project that has received an Impact Study Report. Attachment B is revised to clarify and expand the scope and procedure of the Regional Transmission Expansion Planning Process.

Revision 05 (06/23/05):

- Revision includes a change in Section 6 to include reference to new Attachment E, re-writes of Attachment C (PJM Deliverability Testing Methods) and Attachment D (PJM Reliability Planning Criteria) and the addition of new Attachment E (Economic Planning Process, Congestion Relief Evaluation).

Revision 04 (12/17/04):

- Revision includes the changes in Sections 2 and 4 necessitated for compliance with FERC Order 2003 for standardized Generator Interconnection Agreements and Procedures, re-write of Attachment F: Facilities Study Guidelines, re-write of Attachment D: PJM Reliability Planning Criteria, and the addition of Attachment H: Small Generator (2MW or less) Technical Requirements and Standards.

Revision 03 (06/08/04):

- Revision includes the addition of rules for Generator Power Factor Requirements and Behind the Meter Generation in Section 2, the designation of small resources as 20 MW or less in Section 4, the addition of the Economic Planning Process in Section 6 and general updates.

Revision 02 (10/31/03):

- Revision includes the addition of Wind-Powered Generator Specific Requirements to Section 2, a placeholder for the addition of the Economic Planning Process in new Section 6 (currently under development) and the addition of Attachments D (Regional Transmission Expansion Plan – Scope and Procedure), E (PJM Deliverability Testing Methods), F (General Description of Facilities Study Procedure) and G (PJM Reliability Planning Criteria); also, text changes throughout to conform with Nuclear Plant Licensee Final Safety Analysis Report grid requirements and with new Manual M-14E (Merchant Transmission Specific Requirements – also currently under development).

Revision 01 (02/26/03):

- Revision includes a manual title change from PJM Manual for Generation Interconnection Transmission Planning (M-14B) to PJM Manual for Generation and Transmission Interconnection Planning (M-14B); also, text changes throughout to conform to new Manuals M-14C and M-14D.

Revision 00 (12/18/02):

- This document is the initial release of the PJM Manual for Generation Interconnection Transmission Planning (M-14B).
- Manual M-14, Revision 01 (03/03/01) has been restructured to create five new manuals:

- M-14A: “Generation Interconnection Process Overview”
- M-14B: “Generation Interconnection Transmission Planning”
- M-14C: “Generation Interconnection Facility Construction”
- M-14D: “Generation Operational Requirements”
- M-14E: “Merchant Transmission Specific Requirements”