

Capacity Interconnection Rights (CIR) Transfer Process Education

Ed Franks

Interconnection Analysis Department

Interconnection Process Subcommittee

July 31, 2023

- Transfer CIRs from a Deactivation capacity generation resource to a Replacement generation resource
 - Requires an official Deactivation Notice sent to PJM (for the Deactivation resource)
 - Requires a New Service Request application submitted to PJM (for the Replacement resource)
 - Application can be submitted after the Deactivation Notice is received by PJM
 - Application must be submitted before CIRs expire, which is 1 year after the Actual Deactivation Date
 - Must also note the intent to claim and transfer CIRs via submission of “Notice of Intent to Transfer CIRs” form
 - ✓ <https://www.pjm.com/planning/service-requests/application-and-forms>
- The Replacement generation resource, along with the CIR Transfer, is evaluated and processed as part of the PJM New Services Request Process

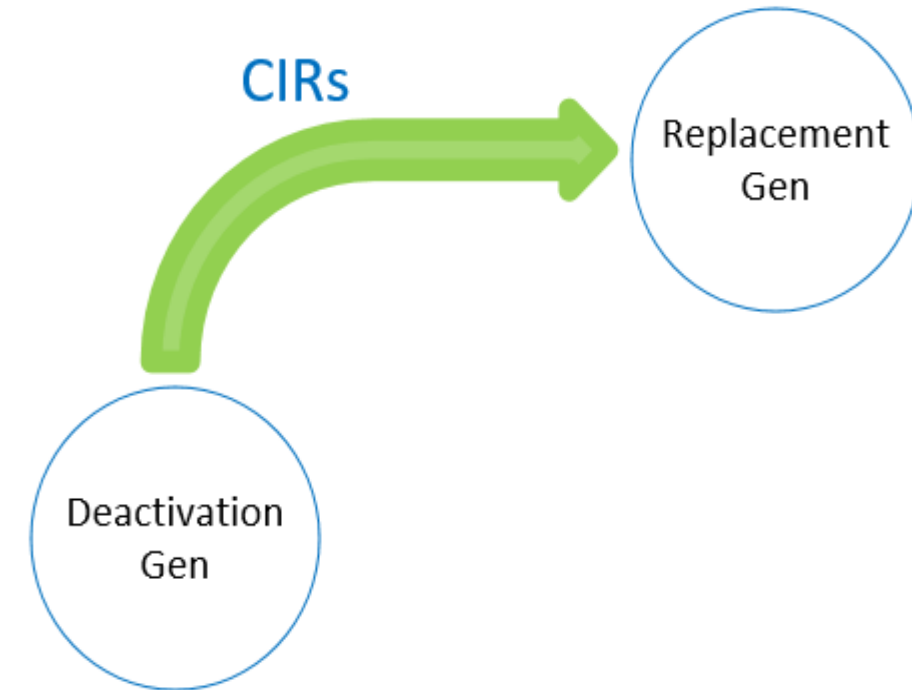

- CIR Transfer Process is applicable to all generation resources provided that the resource has CIRs (i.e. Capacity Generation Resources)
 - Only CIRs may be transferred (i.e. “Capacity MWs”)
 - “Energy-Only” rights/MWs are not eligible for CIR Transfer
- Replacement generation resource is not required to be located at the same Point of Interconnection (POI) as the Deactivation generation resource
 - The CIR Transfer Issue Charge applies only to Replacement Generation Capacity Resources located at the same POI as the Deactivation resource.
 - Different POIs are out of scope of the Issue Charge and CIR Transfers associated with different POIs will remain being processed and evaluated under existing processes.

- Reliability Analysis is done as part of the PJM New Services Request Process, as the Replacement generation resource is required to enter this process.
- Reliability Analysis is performed to:
 1. Determine impacts to system capability for the proposed transfer of CIRs from a Deactivation generation resource to a Replacement generation resource
 - a. Determine impacts to system capability due to the Replacement generation resource itself (i.e. the “CIRs” may not cause a reliability violation, but the electrical characteristics of the Replacement resource may)
 2. Determine and assign cost responsibility for transmission system upgrades, if impacts are found
 - a. The Replacement generation resource is part of a Cycle within the PJM New Services Request Process and cost responsibility may be shared with other New Service Requests in the same Cycle.

- **Load Flow**

- Evaluate thermal system capability by comparing the Deactivation resource's POI, MW capabilities, and Fuel to the Replacement resource's POI, MW capabilities, and Fuel
- Includes various models/seasons (Summer Peak, Winter Peak, Light Load)
 - Key Input #1: What is the delta/difference in magnitude of CIRs being transferred?
 - Key Input #2: Is there additional "Energy-Only" MWs, in addition to the CIRs, being requested by the Replacement resource?
 - Key Input #3: What types of generation are involved in the transfer for both the Deactivating resource as well as the Replacement resource (i.e synchronous, wind, solar, storage, etc.) ?
 - Each generation type can have different Deliverability ramping criteria per the PJM Generator Deliverability Test

- Electrical characteristics of Replacement resource vs. Deactivation resource (key for Short Circuit & Stability)

- Machine parameters (synchronous generator, inverter)
- Other equipment parameters (transformers, collector system, attachment line)

- **Short Circuit**

- Evaluate short circuit capability on the system by comparing the Deactivation resource's POI and Electrical characteristics to the Replacement resource's POI and Electrical characteristics
- Does the Replacement resource cause an increase in fault current as compared to the Deactivation resource ?
- If so, is there any equipment overstressed that would require upgrading?

- **Stability**

- Monitor system performance by comparing the Deactivation resource's POI, MW output, and Electrical characteristics to the Replacement resource's POI, MW output, and Electrical characteristics
- Does the Replacement resource introduce any instability on the system as compared to the Deactivation resource?

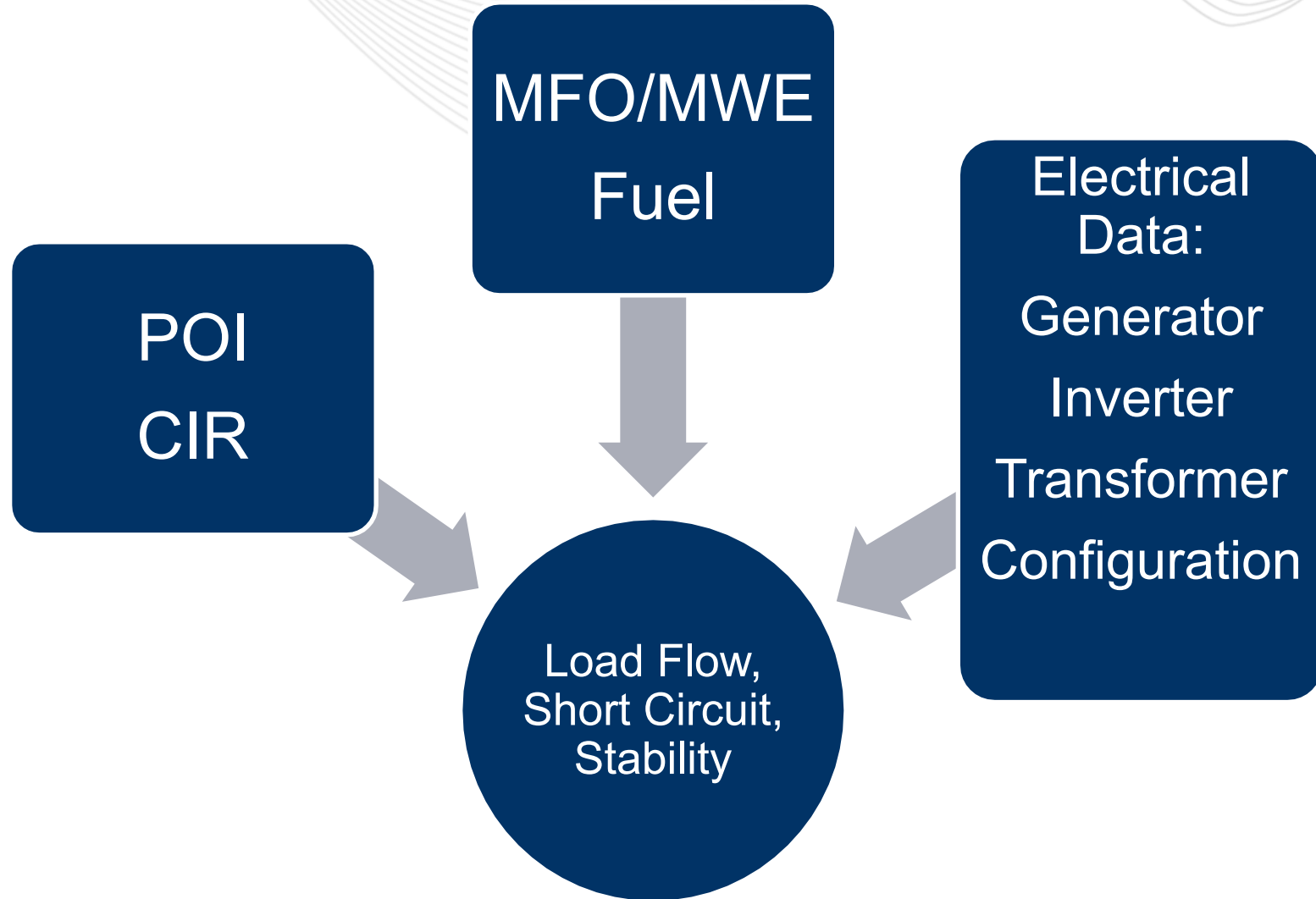

Evaluation of CIR Transfers – Example 1 (Load Flow)(same fuel type)

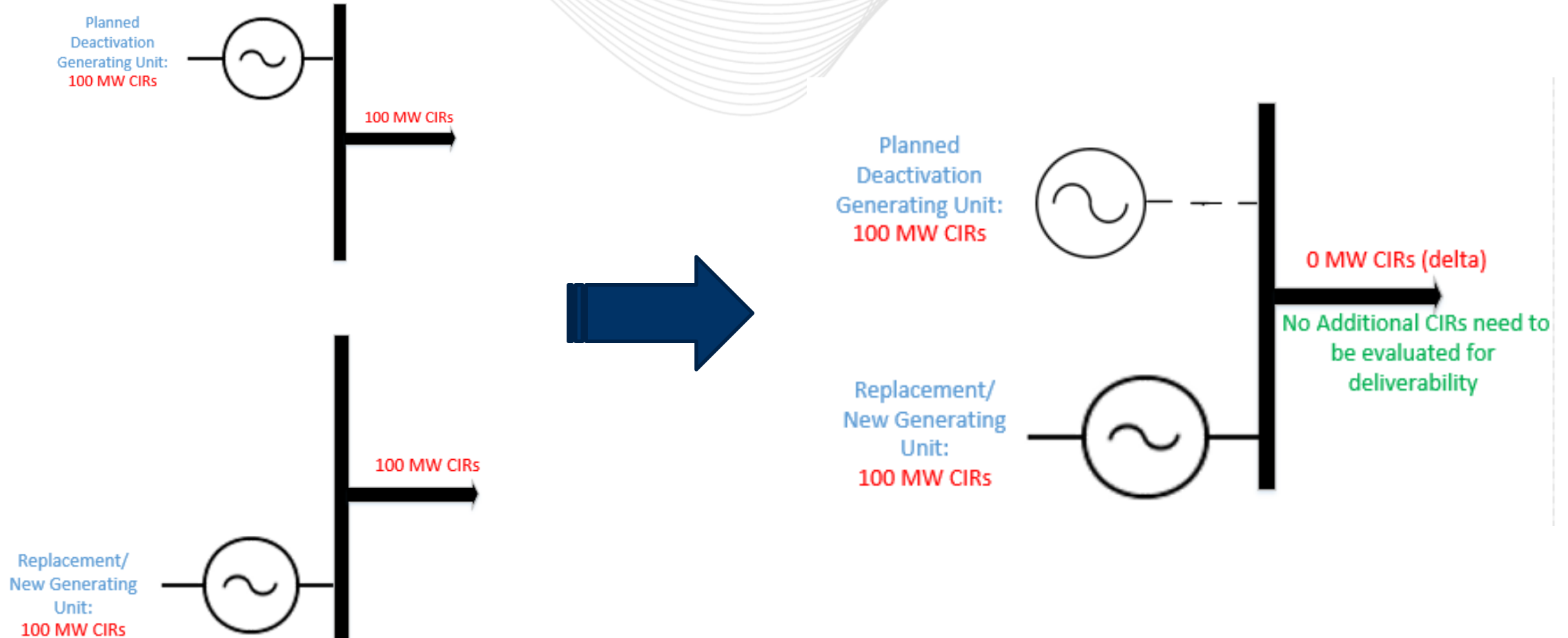

Evaluation of CIR Transfers – Example 2 (Load Flow)(same fuel type)

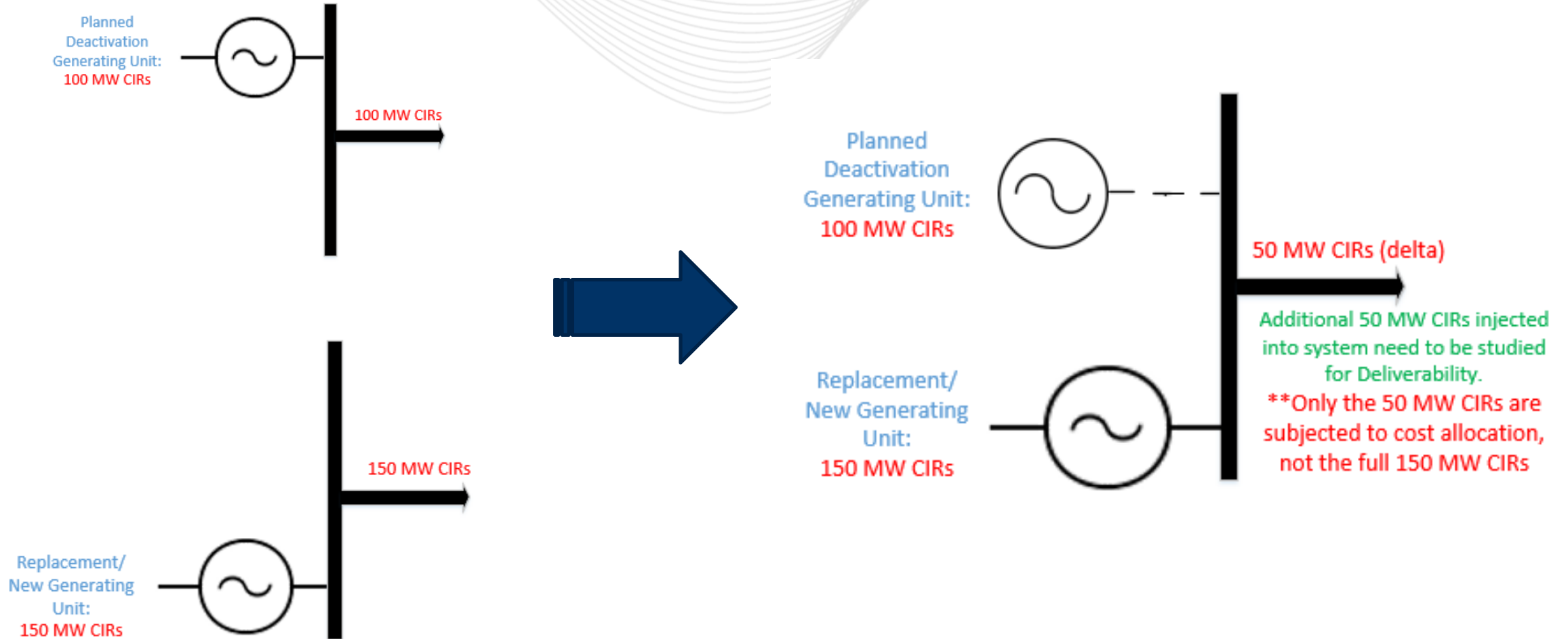

Evaluation of CIR Transfers – Example 3 (Load Flow)(same fuel type)

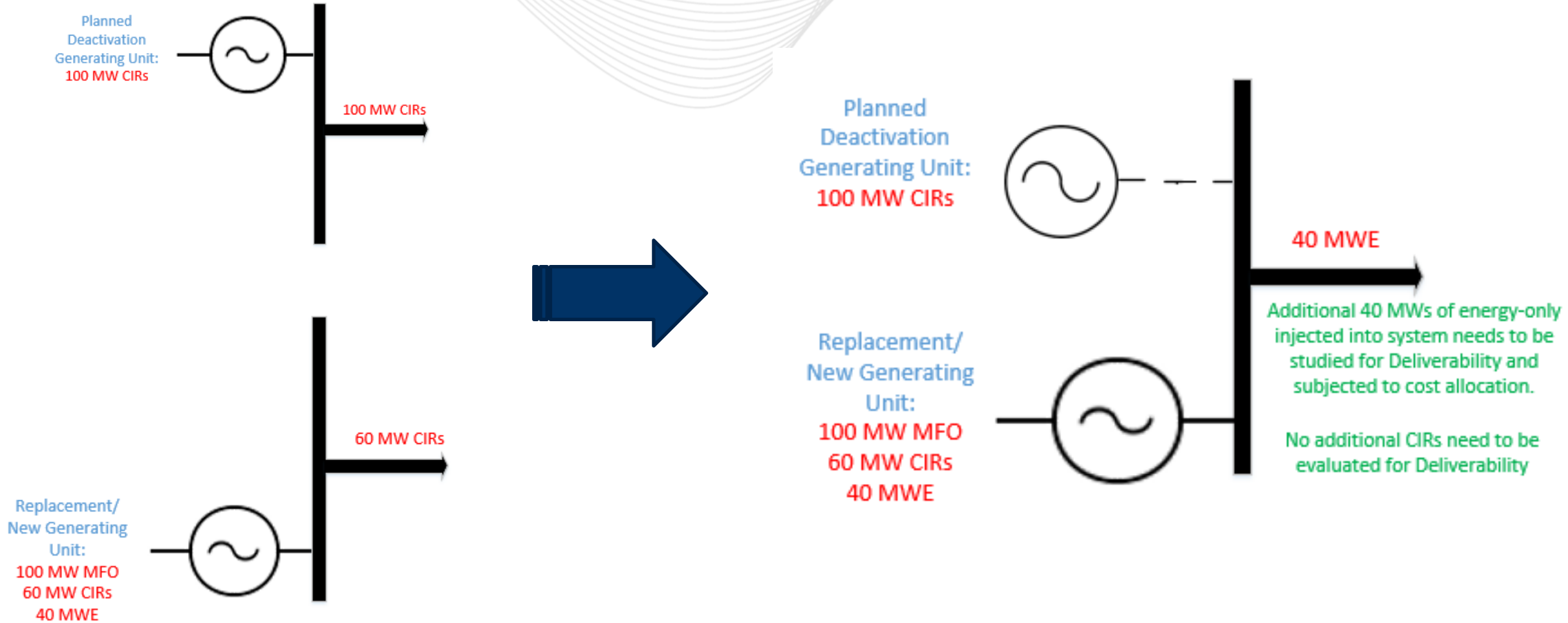



Evaluation of CIR Transfers – Example 4 (Load Flow)(different fuel type)

	Summer Peak Deliverability		Winter Peak Deliverability		Light Load Deliverability	
	Single Contingency	Common Mode Contingency	Single Contingency	Common Mode Contingency	Single Contingency	Common Mode Contingency
Deactivation Resource (Coal)	CIR	Max Summer Net	Max Winter Net	Max Winter Net	If in Base Dispatch: CIR*(1-PJM EEFORd) If not in Base Dispatch: 0	If in Base Dispatch: CIR*(1-PJM EEFORd) If not in Base Dispatch: 0
Replacement Resource (Tracking Solar)	CIR	P80%	P80%	P80%	Capacity Factor	Capacity Factor

Ramping limits/criteria above per new PJM Generator Deliverability Test (M14B), approved in Jan. 2023. For more details, please see M14B.

	Summer Peak Deliverability		Winter Peak Deliverability		Light Load Deliverability	
	Single Contingency	Common Mode Contingency	Single Contingency	Common Mode Contingency	Single Contingency	Common Mode Contingency
Deactivation Resource (Coal)	100 MW	100 MW	100 MW	100 MW	0 MW	0 MW
Replacement Resource (Tracking Solar)	60 MW	85 MW	5 MW	5 MW	55 MW	55 MW

MW values used in this table are for illustration purposes only.

Thermal Observations:

Summer Peak/Winter Peak: The MWs ramped/delivered from the Deactivating Coal resource exceed the MWs ramped/delivered from the Replacement Solar resource. Thus, there would be no thermal load flow violations introduced by the Replacement Solar resource.

Light Load: The MWs ramped/delivered from the Replacement Solar resource exceed the MWs ramped/delivered from the Deactivating Coal resource. Thus, there could be thermal load flow violations introduced by the Replacement Solar resource that would require testing.

Evaluation of CIR Transfers – Example 5 (Short Circuit)

Planned
Deactivation
Generating Unit:
100 MW CIRs

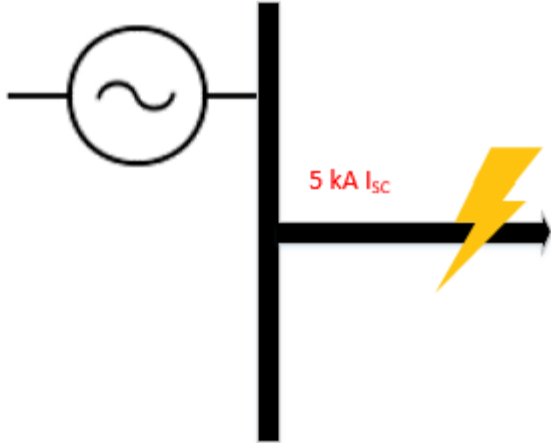

Planned
Deactivation
Generating Unit:
100 MW CIRs

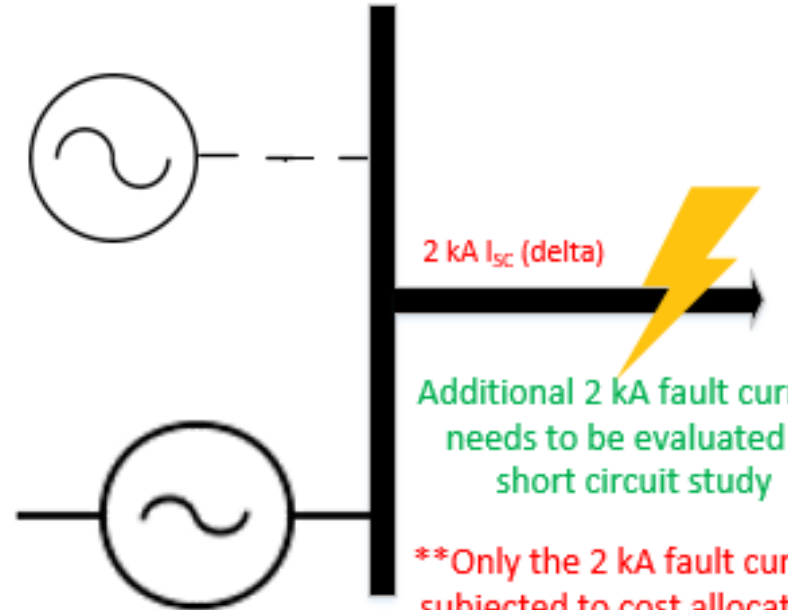

Replacement/
New Generating
Unit:
100 MW CIRs

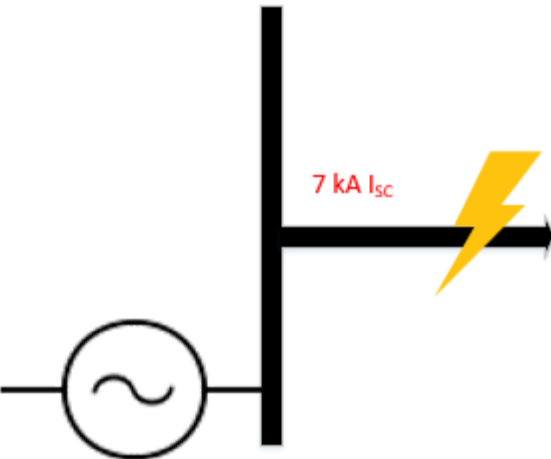

Replacement/
New Generating
Unit:
100 MW CIRs

Additional 2 kA fault current
needs to be evaluated in
short circuit study

**Only the 2 kA fault current
subjected to cost allocation,
not the full 7 kA

- PJM Tariff, Part VI
 - Sections 230.3.3 & 230.4
- PJM Tariff, Part VIII
 - Section 403, D.1
 - Section 426, C.3 & C.4
- PJM Manual 14H (seek endorsement at 7/26/23 MRC)
 - Section 2.2.1
 - Section 9.5.3
- PJM Manual 14B
 - Attachment C.3 “Deliverability of Generation” (i.e. Generator Deliverability Test)

Presenter:
Ed Franks

Edmund.Franks@pjm.com

CIR Transfer Process Education



Member Hotline

(610) 666 – 8980

(866) 400 – 8980

custsvc@pjm.com