

Revised October 15, 2014

**Joint Reliability Coordination Agreement
Among And Between
PJM Interconnection, L.L.C., And
Tennessee Valley Authority**

Date: October 15, 2014

Joint Reliability Coordination Agreement Change Summary

Revision 1.1 (August 8, 2014)

Following revisions were made to this Joint Reliability Coordination Agreement:

- a) Deleted references to Midcontinent Independent System Operator (“MISO”) as the MISO no longer has signatory obligations to the JRCA;
- b) Deleted Section 6.4, which pertains to contract paths,;
- c) Included version 1.9 of the Congestion Management Process as attachment 1 to the JRCA; and
- d) Deleted Appendix E (*TLR Avoidance*).

TABLE OF CONTENTS

ARTICLE ONE - RECITALS	1
ARTICLE TWO - ABBREVIATIONS, ACRONYMS, AND DEFINITIONS.....	2
2.1 Abbreviations and Acronyms.	2
2.2 Definitions.....	4
2.3 Rules of Construction	9
ARTICLE THREE - OVERVIEW, ADMINISTRATION, AND RELATIONSHIP WITH OTHER AGREEMENTS	10
3.1 Overview and Scope of this Agreement	10
3.2 Relationship Between This Agreement And The Joint Operating Agreement.....	11
3.3 Establishment and Functions of Operating Committee	11
3.4 Ongoing Review and Revisions.....	12
ARTICLE FOUR - EXCHANGE OF INFORMATION AND DATA.....	12
4.1 Exchange of Operating Data.....	12
4.2 Cost of Data and Information Exchange.....	18
ARTICLE FIVE - AVAILABLE FLOWGATE CAPABILITY CALCULATIONS	18
5.1 Available Flowgate Capability Protocols	18
ARTICLE SIX - RECIPROCAL COORDINATION OF FLOWGATES.....	21
6.1 Reciprocal Coordination of Flowgates Operating Protocols	21
6.2 Costs Arising From Reciprocal Coordination of Flowgates.....	22
6.3 Maintaining Current Flowgate Models.....	22
ARTICLE SEVEN - COORDINATION OF SCHEDULED OUTAGES	22
7.1 Operating Protocols for Coordinating Scheduled Outages.....	22

ARTICLE EIGHT - PRINCIPLES CONCERNING JOINT OPERATIONS IN EMERGENCIES..... 23

8.1 Emergency Operating Principles 23

8.2 Costs of Compliance with Emergency Principles and Procedures 25

ARTICLE NINE - COORDINATED REGIONAL TRANSMISSION EXPANSION PLANNING 26

9.1 JPC 26

9.2 Data and Information Exchange 27

9.3 Coordinated System Planning..... 28

ARTICLE TEN - JOINT CHECKOUT PROCEDURES..... 33

10.1 Scheduling Checkout Protocols 33

ARTICLE ELEVEN - VOLTAGE CONTROL AND REACTIVE POWER COORDINATION..... 34

11.1 Coordination Objectives 34

11.2 Specific Voltage and Reactive Power Coordination Procedures 35

ARTICLE TWELVE - DISPUTE RESOLUTION PROCEDURES 38

12.1 Dispute Resolution Procedures 38

ARTICLE THIRTEEN - RETAINED RIGHTS OF PARTIES 39

13.1 Parties Entitled to Act Separately 39

ARTICLE FOURTEEN - EFFECTIVE DATE, IMPLEMENTATION, TERM AND TERMINATION..... 40

14.1 Effective Date; Implementation..... 40

14.2 Term..... 40

14.3 Right of a Party to Terminate..... 40

14.4 Termination Due to Regulatory Action 40

14.5 Termination Due To FERC Modification..... 40

14.6 Change in NERC..... 40

14.7	Survival	40
14.8	Post-Termination Cooperation.....	41
ARTICLE FIFTEEN - CONFIDENTIAL INFORMATION.....		41
15.1	Definition	41
15.2	Protection	42
15.3	Scope.....	42
15.4	Standard of Care	42
15.5	Required Disclosure.....	42
15.6	Return of Confidential Information	43
15.7	Equitable Relief	43
ARTICLE SIXTEEN - ADDITIONAL PROVISIONS		43
16.1	Unauthorized Transfer of Third-Party Intellectual Property	43
16.2	Intellectual Property Developed Under This Agreement.....	43
16.3	Indemnification	43
16.4	Limitation of Liability.....	44
16.5	Permitted Assignments	44
16.6	Liability to Non-Parties.....	44
16.7	Force Majeure	44
16.8	Amendment.....	45
16.9	Headings	45
16.10	Counterparts	45
16.11	Notices	45
16.12	Governing Law	45
16.13	Prior Agreements; Entire Agreement.....	46
ATTACHMENT 1 – CONGESTION MANAGEMENT PROCESS (CMP) MASTER.....		47

**Joint Reliability Coordination Agreement
Among And Between
PJM Interconnection, L.L.C., And
Tennessee Valley Authority**

This revised Joint Reliability Coordination Agreement (“Agreement”) dated this 31 day of October 2014, among and between the following parties:

PJM Interconnection, L.L.C. (“PJM”) a Delaware limited liability company having a place of business at 955 Jefferson Avenue, Valley Forge Corporate Center, Norristown, Pennsylvania 19403

Tennessee Valley Authority (“TVA”), a corporate entity existing under the Tennessee Valley Authority Act, 16 U.S.C. §§ 831-831ee.

ARTICLE ONE - RECITALS

1. PJM is the regional transmission organization that provides operating and reliability functions in portions of the mid-Atlantic and Midwest States. PJM also administers an open access tariff for transmission and related services on its grid, and independently operates markets for day-ahead and real-time energy, and financially firm transmission rights;
2. TVA is a transmission provider that provides operating and reliability functions in the TVA Reliability Coordinator area, and administers Transmission Service Guidelines for open access transmission and related services on its system. TVA is not subject to regulation by the Federal Energy Regulatory Commission as a “public utility” under the Federal Power Act;
3. The Federal Energy Regulatory Commission has ordered each regional transmission organization to develop mechanisms to address inter-regional coordination;
4. On May 20, 2004, the Parties entered into a Data Exchange Agreement Among and Between Tennessee Valley Authority, the Midwest Independent Transmission System Operator, Inc., and PJM Interconnection, L.L.C., providing for exchanges of certain data and information in furtherance of inter-regional coordination, the reliability of their systems, and in the case of the regional transmission organizations, efficient market operations;
5. In accordance with section 3.1.1.4 of the Agreement Midwest ISO, PJM, and TVA undertook an effort to review the Agreement between the period of December 2009 and April 2009, and have incorporated a number of changes in this Revised Joint Reliability Coordination Agreement to reflect current operations;
6. In accordance with Good Utility Practice, the Parties seek to establish or confirm other arrangements and protocols in furtherance of the reliability of their systems and efficient market operations, as provided under the terms and conditions of this Agreement, and to incorporate into this Agreement the data and information exchange to which they previously agreed as revised herein;

NOW, THEREFORE, for good and valuable consideration including the Parties' mutual reliance upon the covenants contained herein, the Parties agree to amend and revise the Agreement to read as follows:

ARTICLE TWO - ABBREVIATIONS, ACRONYMS, AND DEFINITIONS

2.1 Abbreviations and Acronyms.

- 2.1.1 "ATC" shall mean Available Transfer Capability.
- 2.1.2 "AFC" shall mean Available Flowgate Capability.
- 2.1.3 "BA" shall mean Balancing Authority.
- 2.1.4 "BAA" shall mean Balancing Authority Area.
- 2.1.5 "CBM" shall mean Capacity Benefit Margin.
- 2.1.6 "CRTPS" shall mean the Coordinated Regional Transmission Planning Study.
- 2.1.7 "DC" shall mean Direct Current.
- 2.1.8 "EHV" shall mean Extra High Voltage.
- 2.1.9 "EMS" shall mean the respective Energy Management Systems utilized by the Parties to manage the flow of energy within their Regions.
- 2.1.10 "ERAG" shall mean the Eastern Interconnection Reliability Assessment Group that is charged with multi-regional modeling.
- 2.1.11 "FERC" shall mean the Federal Energy Regulatory Commission or any successor agency thereto.
- 2.1.12 "FTP" shall mean the standardized file transfer protocol for data exchange.
- 2.1.13 "ICCP", "ISN", and "ICCP/ISN" shall mean those common communication protocols adopted to standardize information exchange.
- 2.1.14 "IDC" shall mean the NERC Interchange Distribution Calculator used for identifying and requesting congestion management relief.
- 2.1.15 "IROL" shall mean Interconnection Reliability Operating Limit.
- 2.1.16 "ISN" shall have the meaning referred to in the reference to ICCP.
- 2.1.17 "JOA" shall mean the Joint Operating Agreement Between The Midwest Independent Transmission System Operator, Inc. and PJM Interconnection, L.L.C., as it may be amended, supplemented, or restated from time to time.

- 2.1.18 "JPC" shall mean the Joint Planning Committee.
- 2.1.19 "kV" shall mean kilovolt of electric potential.
- 2.1.20 "MMWG" shall mean the NERC working group that is charged with multi-regional modeling.
- 2.1.21 "MVAR" shall mean megavolt amp of reactive power.
- 2.1.22 "MW" shall mean megawatt of real power
- 2.1.23 "NAESB" shall mean the North American Energy Standards Board or its successor organization.
- 2.1.24 "NERC" shall mean the North American Electricity Reliability Corporation or successor organization.
- 2.1.25 "NSI" shall mean net scheduled interchange.
- 2.1.26 "OASIS" shall mean the Open Access Same-Time Information System required by FERC for the posting of market and transmission data on the Internet.
- 2.1.27 "OATT" shall mean the applicable open access transmission tariff.
- 2.1.28 "OC" shall refer to the Operating Committee under this Agreement.
- 2.1.29 "PMAX" shall mean the maximum generator real power output reported in MWs on a seasonal basis.
- 2.1.30 "PMIN" shall mean the minimum generator real power output reported in MWs on a seasonal basis.
- 2.2.31 "PSS/E" shall mean Power System Simulator for Engineering.
- 2.1.32 "QMAX" shall mean the maximum generator reactive power output reported in MVARs at full real power output of the unit.
- 2.1.33 "QMIN" shall mean the minimum generator reactive power output reported in MVARs at full real power output of the unit.
- 2.1.34 "RC" shall mean Reliability Coordinator.
- 2.1.35 "RCF" shall mean a Reciprocal Coordinated Flowgate.
- 2.1.36 "RCIS" shall mean the Reliability Coordinator Information System.
- 2.1.37 "RTO" refers to Regional Transmission Organization as defined in FERC's Order No. 2000, or to Midwest ISO and/or PJM, as applicable.
- 2.1.38 "SCADA" refers to a supervisory control and data acquisition system.

2.1.39 “SDX System” shall mean the system used by NERC to exchange system data.

2.1.40 “SOL” shall mean System Operating Limit.

2.1.41 “TFC” shall mean Total Flowgate Capability.

2.1.42 “TLR” shall mean Transmission Loading Relief.

2.1.43 “TOP” shall mean Transmission Operator.

2.1.44 “TRM” shall mean Transmission Reliability Margin.

2.2 Definitions. Any undefined, capitalized term used in this Agreement that is not defined in this Section shall have the meaning given in the preamble of this Agreement or the Congestion Management Process, and if not defined in the preamble or Congestion Management Process, shall have the meaning given under industry custom, and where applicable, in accordance with Good Utility Practice. It is the intent of the Parties that any capitalized term used in this Agreement that is defined in the NERC Glossary of Terms shall have the same meaning as defined in the NERC Glossary of Terms.

2.2.1 “a & b multipliers” shall mean the multipliers that are applied to TRM in the planning horizon and in the operating horizon to determine non-firm AFC. The “a” multiplier is applied to TRM in the planning horizon to determine non-firm AFC. The “b” multiplier is applied to TRM in the operating horizon to determine non-firm AFC. The “a & b” multipliers can vary between 0 and 1, inclusive. They are determined by individual transmission providers based on network reliability considerations.

2.2.2 “Allocation” shall mean a calculated share of capability on a Reciprocal Coordinated Flowgate to be used by Reciprocal Entities when coordinating AFC, transmission sales, and dispatch of generation resources.

2.2.3 “Available Flowgate Capability” shall mean the measure of the flow capability remaining on a Flowgate for further commercial activity over and above already committed uses. It is defined as TFC less Existing Transmission Commitments (ETC), less a Capacity Benefit Margin, less a Transmission Reliability Margin, plus Postbacks, and plus counterflows.

2.2.4 “Balancing Authority” shall mean the responsible entity that integrates resource plans ahead of time, maintains load-interchange-generation balance within a Balancing Authority Area, and supports interconnection frequency in real time.

2.2.5 “Balancing Authority Area” shall mean the collection of generation, transmission, and loads within the metered boundaries of the Balancing Authority. The Balancing Authority maintains load-resource balance within this area.

- 2.2.6** “Bulk Electric System” shall mean the electrical generation resources, transmission lines, interconnections with neighboring systems, and associated equipment, generally operated at voltages of 100 kV or higher. Radial transmission facilities serving load with only one transmission source are generally not included in this definition.
- 2.2.7** “Confidential Information” shall have the meaning stated in Section 15.1.
- 2.2.8** “Congestion Management Process” shall mean the Congestion Management Process document attached hereto as Attachment 1 and incorporated herein, as it may be amended, revised, or restated from time to time.
- 2.2.9** “Coordinated Flowgate” shall mean a Flowgate impacted by an Operating Entity as determined by one of the four studies detailed in Section 3 of the Congestion Management Process. For a Market-Based Operating Entity, these Flowgates shall be subject to the requirements under the Congestion Management portion of the Congestion Management Process (Sections 4 and 5). A Coordinated Flowgate may be under the operational control of a Third Party.
- 2.2.10** “Coordinated Operations” shall mean all activities that will be undertaken by the Parties pursuant to this Agreement.
- 2.2.11** “Coordinated Regional Transmission Planning Study” shall have the meaning stated in Section 9.3.4.
- 2.2.12** “Designated Network Resource” shall mean a resource that has been identified as a designated network resource pursuant to the PJM tariffs or Transmission Service Guidelines.
- 2.2.13** “Effective Date” shall have the meaning stated in Section 14.1.
- 2.2.14** “Extra High Voltage” shall mean voltages of 230 KV and above.
- 2.2.15** “Facilities Study” shall mean a study conducted by the Transmission Service Provider, or its agent, either: (1) for the interconnection customer to determine a list of facilities, the cost of those facilities, and the time required to interconnect a generating facility with the transmission system; or (2) to enable the sale of firm transmission service.
- 2.2.16** “Firm Flow” shall mean the estimated impacts of firm transmission service on a particular Coordinated Flowgate.
- 2.2.17** “Firm Flow Limit” shall mean the maximum value of Firm Flows an entity can have on a Coordinated Flowgate based on the procedures defined in Sections 4 and 5 of the Congestion Management Process.
- 2.2.18** “Flowgate” shall mean a representative modeling of facilities or groups of facilities that may act as significant constraint points on the regional system.

- 2.2.19** “Good Utility Practice” shall mean any of the practices, methods, and acts engaged in or approved of by a significant portion of the electric utility industry during the relevant time period, or any of the practices, methods, and acts which, in the exercise of reasonable judgment in light of the facts known at the time the decision was made, could have been expected to accomplish the desired result at a reasonable cost consistent with good business practices, reliability, safety, and expedition. Good Utility Practice is not intended to be limited to the optimum practice, method, or act to the exclusion of all others, but rather to be acceptable practices, methods, and acts generally accepted in the region.
- 2.2.20** “Governing Document” shall mean the PJM Open Access Transmission Tariff, the PJM Operating Agreement, the PJM Consolidated Transmission Owners Agreement, the PJM Reliability Assurance Agreement, or any other applicable agreement approved by the FERC and intended to govern the relationship by and among PJM and any of its members or market participants.[]
- 2.2.21** “Governmental Authority” shall mean any federal, state, regional, local, or foreign court, tribunal, government, governmental agency, military, governmental or regulatory body (including any stock exchange, automated quotation system, or self-regulatory body), or authority over the transmission and/or generation facilities of a Party or the Parties, but shall exclude TVA in its capacity as a Party under this Agreement but shall not exclude TVA in any other capacity.
- 2.2.22** “Intellectual Property” shall mean (i) ideas, designs, concepts, techniques, inventions, discoveries, or improvements, regardless of patentability, but including without limitation patents, patent applications, mask works, trade secrets, and know-how; (ii) works of authorship, regardless of copyright ability, including copyrights, and any moral rights recognized by law; and (iii) any other similar rights, in each case on a worldwide basis.
- 2.2.23** “Interconnection Reliability Operating Limit” shall mean a System Operation Limit that, if violated, could lead to instability, uncontrolled separation(s) or Cascading Outages that adversely impact the reliability of the Bulk Electric System.
- 2.2.24** “Interconnection Service” shall mean the service provided by the Transmission Service Provider associated with interconnecting a generating facility to the transmission system and enabling the transmission system to receive electric energy and capacity from the generating facility at the point of interconnection, pursuant to the terms of the generator interconnection agreement and any applicable provisions of a tariff or TVA’s generator interconnection procedures.
- 2.2.25** “Interconnection Study” shall mean any of the following studies: the preliminary interconnection feasibility study; the interconnection System Impact Study; the interconnection Facilities Study; or the restudy of any of the above, as may be described in a Party’s generator interconnection procedures.
- 2.2.26** “Joint Planning Committee” shall have the meaning referred to in Section 9.1.

- 2.2.272.2.28** “Market-Based Operating Entity” shall mean an Operating Entity that operates a security constrained, bid-based economic dispatch bounded by a clearly defined market area.
- 2.2.29** “Market Flows” shall mean the calculated energy flows on a specified Flowgate as a result of dispatch of generating resources serving market load within a Market-Based Operating Entity’s market (excluding tagged transactions).
- 2.2.30** “NAESB Business Practices” shall mean the NAESB business practice standards approved by FERC as mandatory for each electric public utility.
- 2.2.31** “NERC Compliance Registry” shall mean the official list maintained by NERC of all organizations required to comply with the reliability standards approved by FERC.
- 2.2.32** “Network Upgrades” shall have the meanings as defined in the PJM tariffs, the Transmission Service Guidelines, and TVA’s generator interconnection procedures.
- 2.2.33** “Notice” shall have the meaning stated in Section 16.11.
- 2.2.34** “Operating Committee” shall have the meaning stated in Section 3.3.
- 2.2.35** “Operating Entity” shall mean an entity that operates and controls a portion of the Bulk Electric System with the goal of ensuring reliable energy interchange between generators, loads, and other operating entities.
- 2.2.36** “Party” or “Parties” refers to each party to this Agreement or all, as applicable.
- 2.2.37** “Purchasing-Selling Entity” shall mean the entity that purchases or sells, and takes title to, energy, capacity, and services (exclusive of basic energy and transmission services) that are required to support the reliable operation of interconnected Bulk Electric Systems.
- 2.2.38** “Reciprocal Coordinated Flowgate” shall mean a Flowgate that is subject to reciprocal coordination by Operating Entities, under either this Agreement (with respect to the Parties only) or a Reciprocal Coordination Agreement between one or more Parties and one or more Third Party Operating Entities. An RCF is:
- A Coordinated Flowgate that is (a) (i) within the operational control of a Reciprocal Entity or (ii) may be subject to the supervision of a Reciprocal Entity as a RC, and (b) affected by the transmission of energy by the Parties or by one of the Parties and one or more Reciprocal Entities; or
 - A Coordinated Flowgate that is (a) affected by the transmission of energy by one or both Parties and one or more Third Party Operating Entities, and (b) expressly made subject to Congestion Management Process reciprocal

coordination procedures under a Reciprocal Coordination Agreement between or among such Parties and Third Party Operating Entities; or

- A Coordinated Flowgate that is designated by agreement of the Parties as an RCF.

2.2.39 “Reciprocal Coordination Agreement” shall mean an agreement between Operating Entities to implement the reciprocal coordination procedures defined in the Congestion Management Process.

2.2.40 “Reciprocal Entity” shall mean an Operating Entity that coordinates the future-looking management of Flowgate capability in accordance with a Reciprocal Coordination Agreement.

2.2.41 “Reliability Coordinator” shall mean the entity approved by NERC as the highest level of authority who is be responsible for the reliable operation of the Bulk Electric System, has the Wide Area View of the Bulk Electric System, and has the operating tools, processes and procedures, including the authority to prevent or mitigate emergency operating situations in both next-day analysis and real-time operations within an RC Area.

2.2.42 “Reliability Coordinator Area” (“RC Area”) shall mean the collection of generation, transmission, and loads within the boundaries of the Reliability Coordinator. Its boundary coincides with one or more Balancing Authority Areas.

2.2.43 “Reliability Standards” shall mean the NERC reliability standards approved by FERC as mandatory and enforceable against those organizations listed on the NERC Compliance Registry.

2.2.44 “SCADA Data” shall mean the electric system security data that is used to monitor the electrical state of facilities, as specified in NERC policies and procedures.

2.2.45 “Scheduled Outages” shall mean the planned unavailability of transmission and/or generation facilities dispatched by a Party, as described in Article Seven of this Agreement, and do not include forced or other unplanned outages.

2.2.46 “System Impact Study” shall mean an engineering study that evaluates the impact of a proposed interconnection or transmission service request on the safety and reliability of a transmission system and, if applicable, an Affected System. The study shall identify and detail the system impacts that would result if the generating facility were interconnected or transmission service commenced without project modifications or system modifications.

2.2.47 “System Operating Limit” shall mean the value (such as MW, MVAR, amperes, frequency, or volts) that satisfies the most limiting of the prescribed operating criteria for a specified system configuration to ensure operation within acceptable reliability criteria.

- 2.2.48 “Third Party” refers to any entity other than a Party to this Agreement.
- 2.2.49 “Third Party Operating Entity” shall refer to a Third Party entity that operates and controls a portion of the Bulk Electric System with the goal of ensuring reliable energy interchange between generators, loads, and other operating entities.
- 2.2.50 “Total Flowgate Capability” shall mean the maximum amount of power in MW that can flow across the Flowgate without overloading (either on an actual or contingency basis) any element of the Flowgate. If the Flowgate is voltage or stability limited, a MW proxy is determined to ensure adequate voltages and stability conditions.
- 2.1.51 “Transmission Loading Relief” shall mean the procedures used in the Eastern Interconnection as specified in NERC Standards IRO-006 and the NAESB Business Practices WEQ-008.
- 2.2.52 “Transmission Operator” shall mean the entity responsible for the reliability of its “local” transmission system, and that operates or directs the operations of the transmission facilities.
- 2.2.53 “Transmission Owner” shall mean an entity that owns and maintains transmission facilities.
- 2.2.54 “Transmission Reliability Margin” shall mean that amount of transmission transfer capability necessary to ensure that the interconnected transmission network is secure under a reasonable range of uncertainties in system conditions.
- 2.2.55 “Transmission Service Guidelines” shall mean the TVA Transmission Service Guidelines, as amended, revised, or restated from time to time.
- 2.2.56 “Transmission Service Provider” shall mean the entity that administers the transmission tariff or Transmission Service Guidelines and provides transmission service to transmission customers under applicable transmission service agreements.
- 2.2.57 “Transmission System Emergencies” shall mean conditions that have the potential to exceed or would exceed an IROL.
- 2.2.58 “Voltage and Reactive Power Coordination Procedures” shall have the meaning given under Article Eleven.

2.3 Rules of Construction.

- 2.3.1 **No Interpretation Against Drafter.** Each Party participated in the drafting of this Agreement and each Party agrees that no rule of construction or interpretation against the drafter shall be applied to the construction or the interpretation of this Agreement.

- 2.3.2 Incorporation of Preamble and Recitals.** The Preamble and Recitals of this Agreement are incorporated into the terms and conditions of this Agreement and made a part thereof.
- 2.3.3 Rules of Interpretation.** Defined terms in the singular shall include the plural and vice versa, and the masculine, feminine, or neuter gender shall include all genders. Whenever the words “include,” “includes,” or “including” are used in this Agreement, they are not limiting and have the meaning as if followed by the words “without limitation.” The word “Section” refers to the applicable section of this Agreement and, unless otherwise stated, includes all subsections thereof. The word “Article” refers to articles of this Agreement.
- 2.3.4 NERC Reliability Standards.** All activities under this Agreement shall be conducted in a manner that meets or exceeds the applicable Reliability Standards , as such Reliability Standards may be revised from time to time.
- 2.3.5 NAESB Business Practices.** All activities under this Agreement shall be conducted in a manner that meets or exceeds the applicable NAESB Business Practices approved by FERC and incorporated into FERC’s regulations, as such NAESB Business Practices may be revised from time to time.
- 2.3.6 Good Utility Practice.** The Parties shall conduct all activities under this Agreement consistent with Good Utility Practice.
- 2.3.7 Geographic Scope.** Each Party will perform this Agreement with respect to each BA for which the Party serves as Transmission Service Provider, and with respect to each BA for which it serves as RC, provided that a Party be required to perform this Agreement with respect to a BA for which it serves as RC only to the extent that the applicable agreement under which it serves in that capacity permits such performance.

ARTICLE THREE - OVERVIEW, ADMINISTRATION, AND RELATIONSHIP WITH OTHER AGREEMENTS

- 3.1 Overview and Scope of this Agreement.** Subject to Section 3.2, this Agreement provides the following:
- 3.1.1** Arrangements for certain exchanges of information and the implementation of reliability and efficiency protocols between TVA and PJM.
- 3.1.2** The equitable and economical management of congestion on (a) Flowgates affected by flows of TVA and PJM, or (b) in order to encourage and facilitate wide-spread use of the congestion management procedures by Third Parties, on Flowgates affected by the flows of either Party and any Third Party that, by executing a Reciprocal Coordination Agreement, binds itself to the congestion management procedures of this Agreement.
- 3.1.3** Certain arrangements among all of the Parties for coordination of their systems.

3.1.4 Certain arrangements among all of the Parties for administration of this Agreement.

3.2 Relationship Between This Agreement And The Joint Operating Agreement.

Notwithstanding any provision of this Agreement, this Agreement does not govern arrangements solely between Midwest ISO and PJM; such arrangements are governed under the JOA, as amended from time to time. No part of this Agreement shall be construed to amend or replace any part of the JOA. In the event of any conflict between this Agreement and the JOA with respect to any undertakings or agreements between Midwest ISO and PJM under the JOA, the JOA shall control. Nothing in this Agreement shall cause any part of the JOA to be binding upon TVA.

3.3 Establishment and Functions of Operating Committee. To administer the arrangements under this Agreement, the Parties shall establish an OC.

3.3.1 The OC shall have the following duties and responsibilities:

3.3.1.1 Meet no less than annually to address any issues associated with this Agreement that a Party may raise and to determine whether any changes to this Agreement, or procedures employed under this Agreement, would enhance reliability, efficiency, or economy;

3.3.1.2 Conduct additional meetings upon Notice given by any Party, provided that the Notice specifies the reason(s) for the requested meeting;

3.3.1.3 Conduct dispute resolution in accordance with Article Twelve of this Agreement;

3.3.1.4 Initiate process reviews at the request of any Party for activities undertaken in the performance of this Agreement;

3.3.1.5 In its discretion, monitor, evaluate, and collaboratively seek to improve the Congestion Management Process; and

3.3.1.6 In its discretion, take other actions, including the establishment of subcommittees and/or task forces, to address any issues that the OC deems necessary in the implementation of this Agreement.

3.3.2 Operating Committee Representatives. Upon execution of this Agreement, each Party shall designate a primary and alternate representative to the OC and shall inform the other Parties of its designated representatives by Notice. A Party may change its designated OC representatives at any time, provided that timely Notice is given to the other Parties. Each designated OC representative shall have the authority to make decisions on issues that arise during the performance of this Agreement. The costs and expenses associated with each Party's designated OC representatives shall be the responsibility of the designating Party.

3.3.3 Limitations Upon Authority of Operating Committee. Any decision to implement new arrangements or protocols under this Agreement that either Party determines, in its sole discretion, would enhance its costs of performance materially, must be by mutual consent of the Parties' OC representatives.

3.4 Ongoing Review and Revisions. The Parties have agreed to the terms and conditions of this Agreement as their respective systems exist and are contemplated as of the Effective Date. The Parties expect that these systems and technology applicable to those systems and to the collection and exchange of data will change from time to time throughout the term of this Agreement, including changes to the boundaries of a Party in its capacity as an RTO, changes to the boundaries of, or identities of, BAs for which a Party serves as RC, and changes to the BAs included in the security constrained, bid-based economic dispatch markets administered by PJM. The Parties agree that the objectives of this Agreement can be fulfilled only if the Parties, from time to time, review and, as appropriate, revise the requirements stated herein in response to changes, including deleting, adding, or revising requirements and protocols. Each Party shall negotiate in good faith in response to such revisions the other Party may propose from time to time. Nothing in this Agreement, however, shall require either Party to reach agreement with respect to any such changes, or to purchase, install, or otherwise implement new equipment, software, or devices, or functions except as required to perform this Agreement.

ARTICLE FOUR - EXCHANGE OF INFORMATION AND DATA

4.1 Exchange of Operating Data. The Parties shall exchange the following types of data and information: (a) Real-Time and Projected Operating Data; (b) SCADA Data; (c) EMS Models; (d) Operations Planning Data; and (e) Planning Information and Models. The frequency of exchange will be as stated with respect to specific exchanges provided under this Article or, if no frequency is stated, then the frequency shall be as necessary or appropriate to support the purpose of the exchange. Nothing in this Agreement shall require a Party to provide or exchange information that it does not possess or cannot obtain.

To facilitate the exchange of all such data, each Party shall designate to each other Party's Vice President of Operations, a contact to be available twenty-four (24) hours each day, seven (7) days per week, and an alternate contact to act in the absence or unavailability of the primary contact, to respond to any inquiries. With respect to each contact and alternate, each Party shall provide the name, telephone number, e-mail address, and fax number. Each Party may change a designee from time to time by Notice to the other Party's Vice President of Operations.

The Parties agree to exchange data in a timely manner consistent with existing defined formats or such other formats to which the Parties may agree. If any required data exchange format has not been agreed upon as of the Effective Date, or if a Party determines that an agreed format should be revised, a Party shall give Notice of the need for an agreed format or revision and the Parties shall jointly seek to complete development of the format within thirty (30) days of such Notice.

Each Party shall provide the data with respect to all of its transmission customers and, to the extent that the Party is a Market-Based Operating Entity, all entities that participate in the markets it administers, during the term of the Agreement.

4.1.1 Real-Time and Projected Operating Data.

4.1.1.1 The Parties shall exchange the following information:

- (a) Real-time operating information:
 - (i) Generation status of the units in each Party's RC Area;
 - (ii) Transmission line status;
 - (iii) Real-time loads;
 - (iv) Scheduled use of reservations;
 - (v) TLR information, including calculation of Market Flows;
 - (vi) Redispatch information, including the next most economical generation block to decrement/increment; and
 - (vii) List of real-time constraints that are binding in the real-time market solutions.

- (b) Projected operating information:
 - (i) Merit order for generators participating in each Party's RC Area;
 - (ii) Maintenance schedules for generators and transmission facilities in each Party's RC Area;
 - (iii) Transmission service reservations reflecting firm purchase and sales;
 - (iv) Independent power producer information including current operating level, projected operating levels, Scheduled Outage start and end dates;
 - (v) The planned and actual operational start-up dates for any permanently added, removed, or significantly altered transmission segments; and
 - (vi) The planned and actual start-up testing and operational start-up dates for any permanently added, removed, or significantly altered generation units.

4.1.2 Exchange of SCADA Data. With reference to NERC Reliability Standard TOP-005 (Operational Reliability Information) and Attachment 1 - TOP-005 (Electric System Reliability Data):

4.1.2.1 The Parties shall exchange requested transmission power flows, measured bus voltages, and breaker equipment statuses of their bulk transmission facilities via ICCP or ISN.

4.1.2.2 Each Party shall accommodate, as soon as practical, the other Party's request for additional existing ICCP/ISN bulk transmission data points,

but in any event, no more than two (2) week after the request has been submitted.

4.1.2.3 Each Party shall respond to the other Party's request for additional, unavailable ICCP/ISN bulk transmission data points as soon as practical but no later than two (2) weeks after the request has been submitted.

4.1.2.4 The Parties shall comply with all governing confidentiality agreements executed by the Parties relating to ICCP/ISN data.

4.1.2.5 The Parties shall exchange SCADA data consisting of:

- (a) Status measurements 69 kV and above (breaker statuses) (as available and required to observe for reliability as the respective Parties may determine);
- (b) Analog measurements 69 kV and above (flows and voltages) (as available and required to observe for reliability as the respective Parties may determine);
- (c) Generation point measurements, including generator output for each unit in MW and MVARs, as available;
- (d) Load point measurements, including bus loads, and specific loads at each substation in MW and MVARs, as available;
- (e) BAA net interchange;
- (f) BAA instantaneous demand;
- (g) BAA operating reserves; and
- (h) Identification of other real-time data available through ICCP/ISN.

4.1.3 Models. The Parties shall exchange their detailed EMS models on a quarterly basis in a mutually agreed upon format, and shall also exchange incremental model updates in a mutually agreed upon format as new data becomes available. The quarterly model exchange shall include all the necessary model parameters, seasonal equipment ratings, and one-line drawings that shall be used to expedite the model update process. The Parties shall also exchange updates that represent the incremental changes that have occurred to the EMS model since the most recent update. In addition, ICCP / ISN mapping files should be exchanged on monthly basis in a mutually agreed upon format to reflect metering and ICCP data changes. Incremental updates that would affect the Wide-Area view of the neighboring entity's RC Area should occur in time to ensure all other affected parties can update their models in accordance with their modeling update deadlines.

4.1.4 Operations Planning Data. Upon the written request of a Party, a Party shall provide the information specified in this Section to the extent such information is available or can be obtained.

4.1.4.1 Flowgates. The Parties shall exchange the following information:

- (a) Flowgate definitions including seasonal TFC, TRM, CBM, and a & b multipliers;
- (b) Flowgates to be added on demand;
- (c) List of Coordinated Flowgates;
- (d) List of Flowgates to recognize when selling point-to-point service (if different than the list of Coordinated Flowgates); and
- (e) Firm and non-firm AFC for all Flowgates required under Section 4.1.4.1(c) and (d).

4.1.4.2 Transmission Service Reservations. The Parties shall exchange the following information:

- (a) Daily list of all reservations, hourly increment of new reservations;
- (b) List of reservations to exclude;
- (c) Reservation and interchange schedules, as required to permit the accurate calculation of TFC and AFC values;
- (d) Procedures and practices used to model intra-RTO reservations, reservations on external systems, and reservation netting;
- (e) List of reservations from OASIS that should not be considered in AFC calculations; and
- (f) List of long-term firm reservations not subject to rollover rights.

4.1.4.3 Available Flowgate Capability Data. Each Party shall meet a minimum periodicity for calculating and making available AFCs to the other Party. The minimum periodicity depends on the service being offered. Each Party shall provide the following AFC data to the other Party:

- (a) Hourly for first seven (7) days posted at a minimum, once per hour;
- (b) Daily for days eight (8) through thirty-one (31), posted at a minimum, once per day; and

- (c) Monthly for months two (2) through eighteen (18), posted at a minimum, twice per month.

4.1.4.4 Load Forecast. The Parties shall exchange the following load forecast data and information:

- (a) Hourly for next seven (7) days, daily for days eight (8) through thirty-one (31), and monthly for months two (2) through eighteen (18), submitted once a day;
- (b) Identify the origin of the forecast (e.g., identity of RTO, RC, BAA, etc.);
- (c) Indicate whether this forecast includes transmission system losses, and if it does, indicate what the percent losses are;
- (d) Identify non-conforming loads;
- (e) Indicate how municipal entities, cooperatives, and other entity loads are treated. Indicate whether they are included in the forecast. If so, indicate the total load or net load after removing other entity generation; and
- (f) Requirements under Section 5.1.6.

4.1.4.5 Generator Data. The Parties shall exchange the following generator data:

- (a) Unit owner, bus location in model;
- (b) Seasonal ratings, PMIN, PMAX, QMIN, QMAX;
- (c) Station auxiliaries to extent gross generation has been reported; and
- (d) Regulated bus, target voltage and actual voltage.

4.1.4.6 Designated Network Resources. The Parties shall exchange the following Designated Network Resource data:

- (a) Network Integration Transmission Service Specifications;
- (b) Identification of generators that serve as Designated Network Resources;
- (c) To the extent that Designated Network Resources operate between the RC Areas administered by the Parties

- (i) Indication of treatment as pseudo tie or dynamic/static schedules;
- (ii) Rules for sharing output between joint owners; and
- (iii) Transmission arrangements.

4.1.4.7 Balancing Authority Area Net Interchange from Reservations and Tags. The Parties shall exchange the following data concerning BA net interchange from reservations and tags:

- (a) Any grandfathered agreements that do not appear in OASIS; and
- (b) In cases where tags and reservations cannot be used to develop BAA or zone net interchange, then provide hourly NSI for all generators in the BAAs.

4.1.4.8 Dynamic Schedules. The Parties shall exchange the following data concerning dynamic schedules:

- (a) List of dynamic schedules;
- (b) Identification of the dynamic schedules are being used to move load between the Parties' respective RC Areas;
- (c) Identification of marginal generation zones; and
- (d) Requirements under Section 5.1.11.

4.1.4.9 Controllable Devices. The Parties shall exchange the following controllable devices data:

- (a) Phase shifters;
- (b) Market-dispatchable demand response resources greater than 50 MW;
- (c) DC lines; and
- (d) Back-to-back AC/DC converters.

4.1.4.10 Generation and Transmission Scheduled and Forced Outages. The Parties shall exchange the following data concerning Scheduled Outages of generation and transmission and forced outages:

- (a) Scheduled Outages of generation resources that are planned or forecast, as soon as practicable, including all data specified in Section 5.1.1;

- (b) Scheduled Outages of transmission resources that are planned or forecast, as soon as practicable, including all data specified in Section 5.1.3; and
- (c) Notification of all forced outages of both generation and transmission resources, not to exceed 30 minutes after they are identified.

4.2 Cost of Data and Information Exchange. Each Party shall bear its own cost of providing the data and information to the other Party as required under this Article Four and otherwise under this Agreement.

ARTICLE FIVE - AVAILABLE FLOWGATE CAPABILITY CALCULATIONS

5.1 Available Flowgate Capability Protocols. As of the Effective Date, the Parties shall use the SDX System to exchange the planned status of all generators rated greater than 50 MW, Scheduled Outages of all interconnections and other transmission facilities operated at greater than 100 kV (but not to include radial transmission facilities serving only load within one transmission source), and peak load forecasts subject to SDX Data Exchange Requirements.

5.1.1 Scheduled Outages of Generation Resources. Each Party shall provide the projected status of generation availability for a minimum of twelve (12) months, or for a longer period if the information is available. The Parties shall update this data no less than once daily for the full posting horizon and more often as required by system conditions. The data will include complete generation maintenance schedules and the most current available generator availability data, such that each Party is aware of each "return date" of a generator from a scheduled or forced outage. At all times, this exchange will include the status of generators rated greater than 50 MW. If the status of a particular generator of equal to or less than 50 MW is used within a Party's AFC calculation, the status of this unit shall also be supplied.

5.1.2 Generation Dispatch Order. As necessary to permit a Party to develop a reasonably accurate dispatch for any modeled condition, each Party shall provide a typical generation dispatch order or the generation participation factors of all units on an affected BAA basis. The generation dispatch order will be updated as required by changes in the status of the unit; however, a new generation dispatch order need not be provided more often than prior to each peak load season.

5.1.3 Scheduled Outages of Transmission Resources. Each Party shall provide the projected status of Scheduled Outages of transmission facilities above 100 kV (but not to include radial transmission facilities serving only load within one transmission source) for a minimum of the next twelve (12) months or for a longer period if available. This data shall be updated no less than once daily for the full posting horizon and more often as required by system conditions. The data will include current, accurate, and complete transmission facility maintenance schedules, including the "outage date" and "return date" of a

transmission facility from a Scheduled Outage or forced outage. If the status of a particular transmission facility is critical to the determination of AFC of a Party, the status of this facility shall also be provided.

5.1.4 Transmission Interchange Schedules/Net Scheduled Interchange. Each Party shall make available its reservation and interchange schedules/NSI, as required to permit accurate calculation of AFC values. Due to the high volume of this data, the Parties shall either post this data to a mutually agreed upon site for downloading or utilize tag dump information provided by a Party.

5.1.5 Reservations.

5.1.5.1 Each Party shall post, to a mutually agreed upon site, actual transmission service requests information for integration into each Party's AFC determination process.

5.1.5.2 Each Party shall develop practices for modeling transmission service requests, including external requests, and netting practices for any allowance of counterflows created by reservations in electrically opposite directions. Each Party shall provide the other Party with the procedures developed and implemented to model intra-party requests, requests on external parties, and reservation netting.

5.1.5.3 Each Party shall create, maintain, and exchange a list of reservations from its OASIS that should not be considered in AFC calculations and shall make the list available to the other Party. Each Party shall update the list to reflect changes in a timely manner and no less than once per quarter. If a Party does not include a reservation in its own calculations, the reservation should be excluded in the other Party's analyses.

5.1.5.4 Each Party shall maintain a list of long-term firm reservations that are not subject to rollover rights and shall make that list available to the other Party for use in AFC calculations. Each Party shall update the list to reflect changes in a timely manner and no less than once per quarter.

5.1.6 Load Data. The Parties shall exchange forecasted peak load data for each period (*e.g.*, daily, weekly, and monthly) in accordance with the applicable Reliability Standards and NAESB Business Practices. Since peak load values may only apply to one (1) hour of the period, for the next seven (7) day horizon, the Parties shall provide either (i) hourly load forecasts or (ii) daily peak load forecasts with a load profile. All load forecasts shall be provided on a BAA or zone basis by the applicable Transmission Service Provider, RTO, RC, BA, or other applicable entity, including total distribution forecast by zones.

5.1.7 Calculated Firm and Non-firm Available Flowgate Capability.

The Parties shall utilize data provided under Section 4.1.4.1(e) to facilitate determinations whether transmission service reservations or interchange

schedules will impact Flowgates to extents greater than the applicable (firm or non-firm) AFCs and shall abide by the following procedures:

5.1.7.1 Each Party shall accept or reject transmission service requests based upon projected loadings and AFCs applicable to all Parties' Flowgates and all RCFs; and

5.1.7.2 Each Party shall limit approvals of transmission service requests, between the Parties, including roll-over transmission service, so as to not exceed the lesser of the sum of the thermal or stability capabilities of the tie lines that interconnect the Parties; provided that firm transmission service customers retain the rollover rights and reservation priority granted to them under the applicable Party's OATT or Transmission Service Guidelines; and further provided that if explicitly stated in the applicable service agreement, a Party may limit rollover rights for new long-term firm service if there is not enough AFC to accommodate rollover rights beyond the initial term.

5.1.8 Total Flowgate Capability (Flowgate Rating). The Parties shall exchange (seasonal, normal, and emergency) TFC, as well as all limiting conditions (thermal, voltage, or stability). The Parties shall update this information in a timely manner as required by changes on the transmission system. The Parties acknowledge that these ratings are currently fairly static values and do not currently require frequent updating. Voltage and stability limits may need to be periodically manually updated.

5.1.9 Identification of Flowgates. Each Party shall consider in its TFC and AFC determination process all Flowgates that may initiate a TLR event. As determined in accordance with Section 3 of the Congestion Management Process, Flowgates that have a response factor equal to or greater than the distribution factor cut-off must be included in the evaluating Party's model to the extent inclusion is practical.

5.1.10 Configuration/Facility Changes (for power system model updates).

5.1.10.1 Each Party shall provide to the other Party any transmission configuration changes and generation additions (or retirements) to its transmission system as soon as practical to ensure accurate AFC calculation models. Each Party shall provide a listing of the changes and explicit modeling information for each change. This data exchange shall occur prior to each peak load season and as may be otherwise required.

5.1.10.2 The Parties shall exchange AFC calculation models of their transmission systems as soon as mechanisms can be established to facilitate this exchange.

5.1.11 Dynamic Schedule Flows. Each Party shall provide the other Party with the actual amount and future projection of dynamic schedule flows. All dynamic schedule flows and tags shall be submitted in accordance with NERC policy and procedures.

ARTICLE SIX - RECIPROCAL COORDINATION OF FLOWGATES

6.1 Reciprocal Coordination of Flowgates Operating Protocols.

6.1.1 Obligations to Respect Capability Calculations Applicable to Coordinated Flowgates and Allocations Applicable to RCFs. Each Party shall respect the other Party's determinations of AFC and calculations of firmness (firm, non-firm, network, non-firm hourly) for real-time operations applicable to the other Party's Coordinated Flowgates. Additionally, each Party shall respect the allocations defined by the allocation process set forth in the Congestion Management Process. Due to the provisions of the Tennessee Valley Authority Act, notwithstanding any other provisions of this Agreement, TVA cannot be required to redispatch generation, to the extent that such redispatch involves the sale of energy, to PJM under any circumstances. Any redispatch provided by TVA shall be provided to eligible Third Parties under separate agreements.

6.1.2 Coordination Process for Reciprocal Coordinated Flowgates. The Parties shall maintain the process and timing for exchanging their respective AFC calculations, and Firm Flow calculations/allocations with respect to all RCFs. The process will allocate Flowgate capability on a future-looking basis, including the allocation of firm capability for use in both internal dispatch and sale of transmission service. The Congestion Management Process sets forth the procedure for reciprocal coordination. For any controllable Flowgate, the historically determined Firm Flow on the Flowgate and any allocated rights to that Flowgate under this process are subject to the operating practices of the controllable device. The operating practices of the controllable device will be made available to each Party before a change is made. To the extent the controllable device is able to maintain the schedule across the controllable Flowgate, there are no parallel flows and a historical allocation based on parallel flows will not occur. In this instance, the use of the controllable Flowgate will be limited to entities that have arranged transmission service across the interface formed by the controllable device. To the extent the controllable device cannot maintain the schedule across the controllable Flowgate, there will be a historical allocation based on parallel flows.

6.1.3 Real-Time Operations Process. The Parties' capabilities and real-time actions, and those of any Reciprocal Entities, shall be governed by and be in accordance with the Congestion Management Process.

- 6.2 **Costs Arising From Reciprocal Coordination of Flowgates.** Each Party and Reciprocal Entity shall bear its own costs, if any, of compliance with the Congestion Management Process and this Article.
- 6.3 **Maintaining Current Flowgate Models.** For operations and planning purposes, each Party will maintain a detailed model of those portions of the other Party's systems with respect to which a Party is required to respect the other Party's Coordinated Flowgates, or with respect to which the Party has received allocations. On an ongoing basis, each Party shall populate its model with credible and current data.

ARTICLE SEVEN - COORDINATION OF SCHEDULED OUTAGES

- 7.1 **Operating Protocols for Coordinating Scheduled Outages.** The Parties have an interregional outage coordination process for coordinating transmission and generation Scheduled Outages to ensure reliability. The following provisions shall govern with respect to transmission and generation Scheduled Outage coordination.

- 7.1.1 **Exchange of Transmission and Generation Scheduled Outage Data.** Upon a Party's request, the projected status of generation and transmission availability shall be communicated among the Parties. The Parties shall exchange the most current information on proposed Scheduled Outage information and provide a timely response on potential impacts of proposed Scheduled Outages.

The Parties shall share this information promptly upon its availability, but no less than daily and more often as required by system conditions. The Parties shall utilize a mutually agreed upon format for the exchange of this information, which includes the owning Party's facility name; proposed Scheduled Outage start date and time; proposed facility return date and time; date and time when a response is needed from the impacted Party to modify the proposed schedule; and any other information that may be relevant to the reliability assessment.

Each Party shall also provide information independently on approved and anticipated Scheduled Outages formatted as required for the SDX System.

- 7.1.2 **Evaluation and Coordination of Transmission and Generation Scheduled Outages.** Each Party shall utilize network applications to analyze planned critical facility maintenance to determine the effects on the reliability of its transmission system. Each Party's Scheduled Outage analysis will consider the impact of its critical Scheduled Outages on the other Party's system reliability, in addition to its own. The analysis will include, at a minimum, an evaluation of contingencies including potential real or reactive power concerns; voltage analysis; and real and reactive power reserve analysis.

On a weekly basis, daily if requested by a Party, the operations staffs of the Parties shall jointly discuss any Scheduled Outages to identify potential impacts. These discussions shall include an indication of either concurrence with the Scheduled Outage or identify significant impact due to the Scheduled Outage as scheduled. No Party has the authority to cancel the other Party's Scheduled

Outage (except transmission facilities interconnecting the two Parties' transmission systems); provided, however, that the Parties shall work together to resolve any identified Scheduled Outage conflicts. Consideration will be given to Scheduled Outage submittal times and Scheduled Outage criticality when addressing conflicts. If analysis of Scheduled Outages indicates unacceptable system conditions, the Parties shall work with one another and the facility owner(s), as necessary, to provide remedial steps to be taken in advance of proposed maintenance. If an operating procedure cannot be developed, and a change to the proposed schedule is necessary based on significant impact, the Parties shall discuss the facts involved, and make every effort to effect the requested schedule change. If this change cannot be accommodated, the Party with the Scheduled Outage shall notify the impacted Party. A request to adjust a proposed Scheduled Outage date must identify the facility(s) overloaded and proposed a similar time frame of more appropriate dates/times for the Scheduled Outage.

The Parties shall notify each other of emergency maintenance and forced outages as soon as possible (but not to exceed 30 minutes) after such conditions are identified. The Parties shall evaluate the impact of emergency and forced outages on the Parties' transmission systems and work with one another to develop remedial steps as necessary.

Changes to Scheduled Outages, both before or after the work has started, may require additional review. Each Party shall consider the impact of these changes on the other Party's system reliability, in addition to its own. The Parties shall contact each other as soon as possible if these changes result in unacceptable system conditions, and shall work with one another to develop remedial steps as necessary.

ARTICLE EIGHT - PRINCIPLES CONCERNING JOINT OPERATIONS IN EMERGENCIES

8.1 Emergency Operating Principles.

8.1.1 In the event an emergency condition is declared in accordance with a Party's published operating protocols, the Parties shall coordinate respective actions to provide immediate relief until the declaring Party eliminates the declaration of emergency. The Parties shall notify each other of emergency maintenance and forced outages that would have a significant impact on the other Party as soon as possible after the conditions are known. The Parties shall evaluate the impact of emergency and forced outages on the Parties' transmission systems and coordinate to develop remedial steps as necessary or appropriate. If the emergency response allows for coordinating with the other Party before action must be taken, the normal procedures for action requests will be followed. The Parties shall conduct joint annual emergency drills, ensure that all operating staffs are trained and certified, if required, and practice the joint emergency drills that include criteria for declaring an emergency, prioritizing action plans, staffing and responsibilities, and communications.

- 8.1.2** In furtherance of maintaining system stability and providing prompt responses to problems, the Parties agree that in situations where there is an actual IROL violation and/or a transmission system is on the verge of imminent collapse, and when there exists a set of applicable emergency principles or an operating guide, each Party shall allow the affected Party to take immediate steps by modifying the normal procedures for action requests so that the Parties and affected Operating Entities can communicate and coordinate simultaneously via telephone conference call or other appropriate means. Subsequent to such departures from normal procedures, the requesting Party shall review the event, develop a report, and provide copies thereof to the other Party and affected Operating Entities.
- 8.1.3** The Parties shall work together and with the BAs with respect to which they serve as RTO or RC, as applicable, to jointly develop and commit to additional emergency principles and operating guides as may be necessary.
- 8.1.4** Transmission System Emergencies may be implemented when, in the judgment of a Party, the system is in an emergency condition that is characterized by the potential, either imminently or for the next contingency, for system instability or cascading, or for equipment loading or voltages significantly beyond applicable operating limits, such that stability of the transmission system cannot be assured, or to prevent a condition or situation that in the judgment of a Party is imminently likely to endanger life or property. In the event that it becomes necessary for a Party to declare a Transmission System Emergency for an area that is in close electrical proximity to any of the Parties' RC Areas, the affected Parties shall either (i) declare a Transmission System Emergency or (ii) redispatch without declaring a Transmission System Emergency, and take the necessary action(s) in kind to address the situation that prompted the Transmission System Emergency. These actions may include:
- (a) Curtailment of equivalent amounts of firm point-to-point transactions within the affected Parties;
 - (b) Redispatching of generation within the affected Parties; and
 - (c) Load shedding within the affected Parties.
- 8.1.5** In situations where an actual IROL violation exists, or for the next contingency that would exist, and the transmission system is currently, or for the next contingency would be, on the verge of imminent collapse, and there is not an existing emergency principle or operating guide, a Party shall receive and, subject to the next two sentences of this Section, implement the instruction of the affected Party, communicate the instruction to the affected entity within its own RC Area, or utilize telephone conference call capabilities or other appropriate means of communication to allow simultaneous coordination/communication between the Parties and the affected entity. All occurrences of this kind may be reviewed by the Parties after the fact, but the instruction of the affected Party shall be implemented when issued, except a Party may delay implementation in instances where a Party concludes that the requested action will result in a more serious

condition on the transmission system, or the requested action is imminently likely to endanger life or property. Any such delay shall be immediately communicated so alternative mitigating actions can be executed. Financial considerations shall have no bearing on actions taken to prevent the collapse of the transmission system.

- 8.1.6** In a situation where an SOL violation exists within a Party's RC Area, or for the next contingency would exist, the Parties shall work together and take the necessary action(s) in kind to address the situation.
- 8.1.7** The Party shall coordinate as RC with the other Party and, as may be provided under arrangements other than this Agreement, direct emergency action on the part of generation or transmission within such BAAs to protect the reliability of the transmission system. Each Party shall exercise such authority as required to resolve emergency conditions in the other Party's RC Area of which it is aware and, in conjunction with any applicable stakeholder processes, shall develop detailed emergency operating procedures.
- 8.1.7.1 Power System Restoration.** During any power system restoration, the Parties shall coordinate their actions with each other, as well as with other appropriate entities in order to restore the transmission system as safely and efficiently as possible. To enhance the effectiveness of actual restoration operations among the Parties, the Parties shall conduct annual coordinated restoration drills that stress cooperation and communication among the Parties.
- 8.1.7.2 Joint Voltage Stability Operating Protocol.** To avoid any voltage stability or collapse problems, the Parties shall coordinate their operations to maintain stable voltage profiles throughout their respective RC Areas. The Parties shall also coordinate their established daily voltage/reactive management plans.
- 8.1.7.3 Operating the Most Conservative Result.** When a Party identifies an overload/emergency situation that may impact the other Party's system and the affected Party's results/systems do not observe a similar situation, the Parties shall operate to the most conservative result until the Parties can identify the reasons for these difference(s).
- 8.2 Costs of Compliance with Emergency Principles and Procedures.** In accordance with each Party's OATT, Transmission Service Guidelines, or other agreements, each Party shall bear its own costs of compliance with this Article. Nothing in this Agreement shall require a Party to purchase emergency energy if the Party cannot recover the costs under an OATT, its Transmission Service Guidelines, or other agreement or lawful arrangement. Notwithstanding any other provisions of this Agreement, PJM acknowledges that TVA cannot sell energy, including emergency energy, to any entity that is not an authorized purchaser under the Tennessee Valley Authority Act. Any such sale shall be provided to eligible Third Parties under separate agreements.

ARTICLE NINE - COORDINATED REGIONAL TRANSMISSION EXPANSION PLANNING

- 9.1 JPC.** The OC may form, as a subcommittee of the OC, a JPC. The JPC shall be, comprised of representatives of the Parties' respective staffs in numbers and functions to be identified from time to time. The JPC may establish working groups and/or task forces as deemed appropriate to facilitate performance of the transmission planning objectives outlined in this Article. The JPC shall have a Chairman. The Chairman shall be responsible for: the scheduling of meetings; the preparation of agendas for meetings; the production of minutes of meetings; and for chairing JPC meetings. The Chairman shall serve a one-year calendar term, except that the term of the first Chairman shall commence on the Effective Date and terminate at the end of the calendar year of the Effective Date. The OC shall designate the first Chairman. Thereafter, the right to designate the Chairman shall rotate from Party to Party. The JPC shall coordinate planning of the Parties' respective systems under this Agreement, including the following:
- 9.1.1** Prepare and document detailed procedures for the development of power system analysis models. At a minimum, and unless otherwise agreed, the JPC shall develop common power system analysis models to perform coordinated system planning, as well as models for power flow analyses, short circuit analyses, and stability analyses. For studies of interconnections in close electrical proximity at the boundaries between the systems of the Parties, the JPC shall coordinate the performance of a detailed review of the appropriateness of applicable power system models.
 - 9.1.2** Conduct, on a regular basis, a CRTPS, as set forth in Section 9.3.4.
 - 9.1.3** Coordinate planning activities under this Article Nine, including the exchange of data under this Article and developing necessary report and study protocols.
 - 9.1.4** Maintain an Internet site and e-mail or other electronic lists for the communication of information related to the coordinated planning process.
 - 9.1.5** Meet at least semi-annually to review and coordinate transmission planning activities. Such meetings shall include, as determined by the Parties to be necessary based on internal discussions, discussion of any system operations or market operations issues as they impact long range planning and the coordination of planning between the systems.
 - 9.1.6** Establish working groups as necessary to address specific issues, such as the review and development of the regional plans of each Party and localized seams issues.
 - 9.1.7** Establish a schedule for the rotation of responsibility for data management, coordination of analysis activities, report preparation, and other activities.

9.1.8 The JPC may combine with or participate in similarly established joint planning committees amongst multiple entities engaging in coordinated planning studies under tariff provisions or established under joint agreements to which the Parties are signatories, for the purpose of providing for broader and more effective inter-regional planning coordination.

9.2 Data and Information Exchange. Each Party shall provide the other Party with the following data and information. Unless otherwise indicated, such data and information shall be provided as requested by either Party and as available, on a mutually agreed to schedule but no longer than 60 days from the date of such request.

9.2.1 Data required for the development of load flow cases, short-circuit cases, and stability cases, including ten year load forecasts, including all critical assumptions that are used in the development of these cases.

9.2.2 Fully detailed planning models (up to the next ten (10) years) , as requested by any of the Parties and on a mutually agreed schedule as a part of the development of any joint planning studies provided for under this Article Nine or as otherwise agreed to.

9.2.3 The regional plan document produced by the Party, any long-term or short-term reliability assessment documents produced by the Party, and any operating assessment reports produced by the Party.

9.2.4 The status of expansion studies, system impact studies and generation interconnection studies, such that each Party has knowledge that a commitment has been made to a system enhancement as a result of any such studies.

9.2.5 Transmission system maps for the Party's bulk transmission system and lower voltage transmission system maps that are relevant to the coordination of planning between or among the systems.

9.2.6 Contingency lists for use in load flow and stability analyses, including lists of all single contingency events and multiple facility tower line contingencies, as well as breaker diagrams for the portions of the Party's transmission system that are relevant to the coordination of planning between or among the systems.

9.2.7 The timing of each planned enhancement, including estimated completion dates and project mobilization schedules, and indications of the likelihood a system enhancement will be completed and whether the system enhancement should be included in system expansion studies, system impact studies and generation interconnection studies, and all related applications for regulatory approval and the status thereof. This information shall be provided annually and from time to time upon changes in status.

9.2.8 Identification of and status of interconnection requests that have been received and any long-term firm transmission services that have been approved that may impact the operation of a Party's system in a manner that affects the other Party's

system, shared on the earlier of the identification of the potential impact, within 30 days of such request by the other Party or on a regular schedule as otherwise agreed to by the Parties.

9.2.9 Information regarding long-term firm transmission services on all interfaces relevant to the coordination of planning between or among the systems, shared on the earlier of the identification of the potential impact, within 30 days of such request by the one of the Parties, or on a regular schedule as otherwise agreed to by the Parties.

9.2.11 Load flow and short-circuit data initially will be exchanged in PSS/E format. To the extent practical, the maintenance and exchange of power system modeling data will be implemented through databases. When feasible, transmission maps and breaker diagrams will be provided in an electronic format agreed upon by the Parties. Formats for the exchange of other data will be agreed upon by the Parties from time to time.

9.3 Coordinated System Planning. The Parties shall engage in coordinated system planning to identify expansions or enhancements to transmission system capability that may be needed to maintain reliability and/or improve operational performance. The Parties shall coordinate any and all studies required to assure the reliable, efficient, and effective operation of the transmission systems. The Parties shall conduct such coordinated planning as set forth below

9.3.1 Single Party Planning. Each Party shall engage in such transmission planning activities, including expansion plans, system impact studies, and generator interconnection studies, as necessary to fulfill its obligations under its applicable OATT, Transmission Service Guidelines, or as it otherwise shall deem appropriate. Such planning shall conform to applicable reliability requirements of NERC, applicable regional reliability councils, and any successor organizations thereto. Such planning shall also conform to any and all applicable requirements of Federal or State regulatory authorities. Each Party agrees to prepare a regional transmission planning report that documents the procedures, methodologies, and business rules utilized in preparing and completing the report. Each Party shall share its annual transmission planning reports and assessments with the other Party, as well as any information that arises in the performance of such single party planning activities as is necessary or appropriate for effective coordination between the Parties on an ongoing basis.

9.3.2 Analysis of Interconnection Requests. In accordance with the procedures under which the Parties provide interconnection service, each Party shall coordinate with the other Party the conduct of any studies required in determining the impact of a request for generator or transmission interconnection. Results of such coordinated studies will be included in the impacts reported to the interconnection customers as appropriate. Coordination of studies shall include the following:

9.3.2.1 Upon either the posting to the OASIS of a request for interconnection or the review of the study results related to that request for interconnection,

the Party receiving the request (“direct connect system”) shall determine whether the other Party is potentially impacted. If the other Party is potentially impacted, the direct connect system shall notify such Party and convey the information provided in the posting.

- 9.3.2.2** Following the results of either the preliminary feasibility study or the System Impact Study, the direct connect system shall notify the other Party if the study shows potential reliability concerns on the other Party’s system. After reviewing the results, if a potentially impacted Party determines that its system may be materially impacted by the interconnection, such Party shall contact the direct connect system, and request participation in the applicable interconnection studies. The Parties shall coordinate and mutually agree on with respect to the nature of studies to be performed to test the impacts of the interconnection on the potentially impacted Party, who shall perform the studies. If the Parties cannot mutually agree on the nature of the studies to be performed they can resolve the differences through the dispute resolution procedures documented in Article Twelve. The Parties shall strive to minimize the costs associated with the coordinated study process.
- 9.3.2.3** Any coordinated studies shall be performed in accordance with the study scope and timeline mutually agreed to in 9.3.2.2 above utilizing the responsibility options outlined in 9.3.2.4 below..
- 9.3.2.4** The potentially impacted Party may participate in the coordinated study at the System Impact Study or preliminary feasibility study stage either by taking responsibility for performance of studies of its system if the potentially impacted Party determines that its system may be materially impacted, or by providing input to the studies to be performed by the direct connect system. If the constraints found require infrastructure additions to mitigate them, then the potentially impacted Party shall also perform its own Facilities Study. The interconnection customer and potentially impacted Party shall enter into any study agreements that the potentially impacted Party deems necessary to perform its own studies.
- 9.3.2.5** The costs incurred by the potentially impacted Party in the performance of its studies shall be paid by the interconnection customer in accordance with the provisions of the study agreements between the potentially impacted Party and the interconnection customer. The direct connect system may withhold interconnection rights from the interconnection customer until the interconnection customer satisfies the requirements of the potentially impacted Party.
- 9.3.2.6** The direct connect system and potentially impacted Party shall identify any transmission infrastructure improvements required on their respective systems as a result of the proposed interconnection.

9.3.2.7 Construction and cost responsibility associated with any transmission infrastructure improvements required as a result of the proposed interconnection shall be accomplished under the terms of the applicable OATT, Transmission Service Guidelines, controlling agreements, and consistent with applicable Federal or State regulatory policy and applicable law.

9.3.2.8 In the event that Network Upgrades are required on the potentially impacted Party's system, then interconnection service will commence on a schedule mutually agreed upon among the Parties. This schedule will include milestones with respect to the Network Upgrade construction and the amount of service that can commence after each milestone.

9.3.2.9 Thermal and reactive impacts associated with circulation and other phenomena that result from interconnection and impact the systems of both Parties shall be evaluated in the evaluation of specific requests associated with delivery service.

9.3.2.10 Each Party shall maintain a separate interconnection queue. The JPC shall maintain a composite listing of interconnection requests for all interconnection projects that have been identified as potentially impacting the systems of either Party. The JPC shall post this listing on the Internet site maintained for the communication of information related to the coordinated system planning process.

9.3.3 Analysis of Long-Term Firm Transmission Service Requests. In accordance with applicable procedures under which the Parties provide long-term firm transmission service, the Parties shall coordinate the conduct of any studies required to determine the impact of a request for such service. Results of such coordinated studies will be included in the impacts reported to the transmission service customers as appropriate. Coordination of studies will include the following:

9.3.3.1 The Parties shall coordinate the calculation of AFC values associated with the service, based on contingencies on the systems of each Party that may be impacted by the granting of the service.

9.3.3.2 Upon either the posting to the OASIS of a request for service or review of studies related to the evaluation of that service request, the Party receiving the request shall determine whether the other Party is potentially impacted. If the other Party is potentially impacted, the Party receiving the request shall notify such Party and convey the information provided in the posting.

9.3.3.3 If the potentially impacted Party determines that its system may be materially impacted by granting the service, and the nature of the service is such that a request on the potentially impacted Party's OASIS is unnecessary (i.e., the potentially impacted Party is "off the path"), then such Party shall contact the Party receiving the request and request

participation in the applicable studies. The Parties shall coordinate with respect to the nature of studies to be performed to test the impacts of the requested service on the potentially impacted Party. The Parties shall strive to minimize the costs associated with the coordinated study process. The JPC shall develop screening procedures to assist in the identification of service requests that may impact systems of the Parties other than the Party receiving the request.

- 9.3.3.4** Any coordinated studies shall be performed in accordance with the mutually agreed upon study scope and timeline requirements developed by the Parties. If the Parties cannot mutually agree on the nature and timeline of the studies to be performed they can resolve the differences through the dispute resolution procedures documented in Article Twelve of this Agreement.
- 9.3.3.5** During the System Impact Study, the potentially impacted Party may participate in the coordinated study either by taking responsibility for performance of studies of its system if the potentially impacted Party determines that its system may be materially impacted, or by providing input to the studies to be performed by the Party receiving the request. The potentially impacted Party shall also conduct its own Facilities Study if it identifies constraints on its system that require infrastructure additions to mitigate the constraints. The transmission service customer and potentially impacted Party shall enter into any study agreements that the potentially impacted Party deems necessary to perform its own studies.
- 9.3.3.6** The costs incurred by the potentially impacted Party in the performance of its studies shall be paid by the transmission service customer in accordance with the provisions of the study agreements between the potentially impacted Party and the transmission service customer. The Party receiving the request shall hold the transmission service request in study status until the transmission customer satisfies the requirements of the potentially impacted Party.
- 9.3.3.7** The Party receiving the request and the potentially impacted Party shall identify any transmission infrastructure improvements required on their respective systems as a result of the transmission service request.
- 9.3.3.8** Construction and cost responsibility associated with any transmission infrastructure improvements required as a result of the transmission service request shall be accomplished under the terms of the applicable OATT, Transmission Service Guidelines, controlling agreements, and consistent with applicable Federal or State regulatory policy and applicable law.
- 9.3.3.9** In the event that Network Upgrades are required on the potentially impacted Party's system, then transmission service shall commence on a schedule mutually agreed upon among the Parties. This schedule will

include milestones with respect to the Network Upgrade construction and the amount of service that can commence after each milestone.

9.3.4 Coordinated Transmission Planning Study (CTPS). Each Party agrees to assist in the conduct of the CTPS as follows:

9.3.4.1 Every three years, the Parties shall conduct a CTPS. Sensitivity analyses will be performed, as required, during the off years based on a review by the JPC of discrete reliability problems or operability issues that arise due to changing system conditions.

9.3.4.2 The CTPS shall identify all reliability and expansion issues, and shall propose potential resolutions to be considered by the Parties.

9.3.4.3 Nothing in this Agreement shall obligate either Party in any way to construct, finance, operate, or otherwise support any transmission infrastructure improvements or other transmission-related projects identified in the CTPS. Any decision to proceed with any transmission infrastructure improvements or other transmission-related projects identified in the CTPS shall be set forth in a separate agreement executed by the Parties.

9.3.4.4 Nothing in this Agreement shall give either Party any rights to financial compensation due to the impact of the other Party's transmission plans, including but not limited to its decisions whether or not to construct any transmission infrastructure improvements or other transmission-related projects identified in the CTPS

9.3.4.5 Each Party shall be responsible for providing the technical support required to complete the analysis for the CTPS.

9.3.4.6 The JPC shall develop the scope and procedure for the CTPS. The scope of the CTPS will include evaluations of the transmission systems against reliability criteria, operational performance criteria, and economic performance criteria applicable to each Party.

9.3.4.7 The Parties shall use planning models that are developed in accordance with the procedures to be established by the JPC. Exchange of power flow models will be in a format that is acceptable to each Party.

9.3.4.8 The CTPS will initially evaluate the reliability of the combined transmission systems.

9.3.4.9 The performance of the combined transmission systems will be tested against agreed upon operational and economic criteria, where applicable, using the updated baseline model.

9.3.4.10 Economic criteria applicable to each Party shall be developed by that Party.

9.3.4.11 To the extent that the JPC agrees to combine with or participate in similarly established coordinated transmission planning studies among multiple planning entities as provided for under Section 9.1.8, the CTPS may be integrated into such other coordinated activities, provided that the requirements of the CTPS are integrated into the scope of such other coordinated activities.

9.3.5 Review and Approval Processes. To the extent applicable, each Party shall conduct the necessary stakeholder review and approval process associated with transmission system planning, as required by its OATT or Transmission Service Guidelines, Governing Documents, and/or applicable Federal or State regulatory requirements.

ARTICLE TEN - JOINT CHECKOUT PROCEDURES

10.1 Scheduling Checkout Protocols.

10.1.1 Scheduling Protocols. Each Party shall leverage technology to perform electronic approvals of schedules, and to perform electronic checkouts. The Parties shall follow the following scheduling protocols:

10.1.1.1 Each Party, acting as the scheduling agent for its respective BAs, shall conduct all checkouts with first tier BAs. A first tier BA is any BA that is directly connected to any Party's members' BA or any BA operated by an independent transmission company.

10.1.1.2 The Parties shall require all schedules to be tagged in accord with the NERC tagging standard. For reserve sharing and other emergency schedules that are not tagged, the Parties shall enter manual schedules after the fact into their respective scheduling systems to facilitate checkout between the Parties.

10.1.1.3 When there is a scheduling conflict, the Parties shall work together to modify the schedule as soon as practical. If there is a scheduling conflict that is identified before the schedule has started, then both Parties shall make the correction in real-time. If the schedule has already started and one Party identifies an error, then the Parties shall make the correction at the earliest quarter hour increment. If a scheduling conflict cannot be resolved between the Parties (but the source and sink have agreed to a MW value), then the Parties shall adjust their numbers to that same MW value. If source and sink are unable to agree to a MW value, then the previously tagged value will stand for both Parties.

10.1.1.4 For entities that do not use the Parties' electronic scheduling interfaces, the Parties shall contact the non-member first-tier entities by telephone to perform checkouts. When performing checkouts by telephone, each entity shall verbally repeat the numerical NSI value to ensure accuracy.

10.1.1.5 The Parties shall perform the following types of checkouts:

- (a) Pre-schedule (day-ahead), daily between 1600 and 2000 (eastern prevailing time) hours.
- (b) Hourly Before the Fact (real-time):
 - (i) Checkout for the next hours shall be net scheduled. Import and export totals may also be verified in addition to NSI if it is deemed necessary by a Party. The Parties may checkout individual schedules, if deemed necessary by the Parties;
 - (ii) Hourly checkout is performed starting at the half hour and ending at the ramp hour;
 - (iii) Intra-hour checkout/schedule confirmation shall occur as required due to intra-hour scheduled changes.
- (c) Daily after the fact checkout shall occur no later than ten (10) business days after the fact (via email or a mutually agreed upon method).
- (d) Monthly after the fact checkout shall occur no later than one (1) month after the fact (via phone or a mutually agreed upon method).

10.1.1.6 The Parties shall require that each checkout be performed with first tier BAs. If a checkout discrepancy is discovered, the Parties shall use the NERC tag to determine where the discrepancy exists. The Parties shall require any entity that conducts business within its RC Area to checkout with the applicable Party using NERC tag numbers; a special naming convention used by that entity or other naming conventions given to schedules by other entities will not be permitted.

ARTICLE ELEVEN - VOLTAGE CONTROL AND REACTIVE POWER COORDINATION

11.1 Coordination Objectives. The Parties shall utilize the following procedures ("Voltage and Reactive Power Coordination Procedures"):

11.1.1 The Voltage and Reactive Power Coordination Procedures address the following components: (a) procedures to assist the Parties in maintaining a Wide Area view of interconnection conditions by enhancing the coordination of voltage and

reactive levels throughout their respective RC Areas; (b) procedures to ensure the maintenance of sufficient reactive reserves to respond to scenarios of high load periods, loss of critical reactive resources, and unusually high transfers; and (c) procedures for sharing of data with other neighboring RCs for their analysis and coordinated operation.

11.1.2 The Parties shall review the Voltage and Reactive Power Coordination Procedures from time to time to make revisions and enhancements as appropriate to accommodate additional capabilities or changes to industry reliability requirements.

11.2 Specific Voltage and Reactive Power Coordination Procedures. The Parties shall utilize the following procedures to coordinate the use of voltage control equipment to maintain a reliable bulk power transmission system voltage profile on their respective systems.

11.2.1 Under normal conditions, each Party shall coordinate with the Transmission Owners, TOPs, and BAs as necessary and feasible to supply its own reactive load and losses at all load levels.

11.2.2 Voltage schedule coordination is the responsibility of each Party. Generally, the voltage schedule is determined based on conditions in the proximity of generating stations and EHV stations with voltage regulating capabilities. Each Party works with its respective Transmission Owners, TOPs, and BAs to determine adequate and reliable voltage schedules considering actual and post-contingency conditions.

11.2.3 Each Party shall establish voltage limits at critical locations within its own transmission system and exchange this information with the other Party. This information shall include: normal high voltage limits; normal low voltage limits; post-contingency emergency high voltage limits; and post-contingency emergency low voltage limits; and the voltage limit value (if available) at which load shedding will be implemented.

11.2.4 Each Party shall maintain awareness of the voltage limits in the other Party's areas (where the EMS Model includes sufficient detail to permit this) and awareness of outages and potential contingencies that could result in violation of those voltage limits.

11.2.5 The Parties shall clearly communicate the level of voltage support needed during pre- or post-contingency conditions requiring voltage and reactive power coordination.

11.2.6 Each Party shall maintain a list of actions that are available to be taken when voltage support is necessary to respond to anticipated or prevailing transmission system conditions.

- 11.2.7** The Parties shall exchange voltage schedule information on an annual basis, or more frequently as necessary to reflect actual operations. The Parties shall coordinate as needed to discuss any issues due to the anticipated conditions and determine any actions that may be required in response to voltage concerns.
- 11.2.8** In conjunction with the coordination of Scheduled Outages addressed in Article Seven and the Parties' respective day-ahead reliability analysis processes, the Parties shall coordinate the impact of outages and transmission system conditions on the voltage/reactive profile. Coordination will include the following elements:
- 11.2.8.1** Each Party shall review its forecasted loads, transfers, and all information on available generation and transmission reactive power sources at the beginning of each shift.
- 11.2.8.2** If no reactive problems are anticipated after the review, each Party shall operate independently, in accordance with the above stated criteria and any individual transmission system guidelines for the supply of the Party's reactive power requirements.
- 11.2.8.3** If a Party anticipates reactive problems after the review, it may request joint implementation of reactive support levels under these Voltage and Reactive Power Coordination Procedures, as it deems appropriate to the situation. When a Party calls for a particular level of support to be implemented under these procedures, it or the applicable TOP or BA must identify the time it will start adjusting its system, the support level it is implementing, and the voltage problem area.
- 11.2.8.4** If a Party experiences an actual low or high voltage condition after initial reactive support measures are taken, then the emergency reactive support level is implemented for the area experiencing the problem. The Party shall also notify applicable RCs as soon as feasible. In addition, the Voltage and Reactive Power Coordination Procedures are to be consulted to determine if further action is necessary to correct an undesirable voltage situation.
- 11.2.9** The Parties shall coordinate the use of voltage control equipment to maintain a reliable bulk power transmission system voltage profile on their systems and surrounding systems. The following procedures are intended to ensure that bulk systems voltage levels enhance system reliability.
- 11.2.9.1** Each Party shall coordinate operational control of reactive sources within its transmission system, and will direct adjustments to voltage schedules at appropriate facilities.
- (a) Each Party generally shall adjust its voltage schedules to best utilize its resources for operation, prior to coordinated actions with the other Party.

- (b) If a Party anticipates voltage or reactive problems, it shall inform the other Party of the situation, describe the conditions, and request voltage/reactive support under these procedures. As a part of the request, the Party must identify the specific area where voltage/reactive support is requested, and provide an estimate of the magnitude and time duration of the request as well as the specific requirements for reactive support. The Parties shall determine the appropriate measures to address the condition and develop a plan of action.
- (c) Each Party shall contact its affected Transmission Owners, TOPs, and BAs to ensure that the situation is fully understood and that an effective operating plan to address the situation has been developed. If necessary, the Parties shall convene a conference call with the affected Transmission Owners, TOPs, and BAs.
- (d) Each Party shall implement or direct voltage schedule changes requested by the other Party, provided that a Party may decline a requested change if the change would result in equipment violations or reduce the effective operation of its facilities. A Party that declines a requested change must inform the requesting Party that the request cannot be granted and state the reason for denial.

11.2.10 Voltage/Reactive Transfer Limits.

11.2.10.1 Each Party may monitor power transfer on interfaces defined as a Flowgate used to control voltage collapse conditions. In cases where the potential for voltage collapse (or cascading) is identified, prompt voltage support, and generation adjustments may be needed. Where coordinated effort is required for voltage stability interfaces, generation adjustment requests to avoid voltage collapse or cascading conditions must be clearly communicated and implemented promptly. Using these limits, the Parties shall implement the following real-time coordination:

- (a) At 95% of Interface Limit:
 - (i) A Party, which observes the reading, shall contact the other Party to discuss whether further analysis is required.
 - (ii) The Party, owning the applicable Flowgate, shall notify other RCs via the RCIS.
 - (iii) The Parties shall contact the affected TOPs and BAs to discuss reactive outputs and any adjustments required.

(iv) The affected Party shall take appropriate actions, which may include redispatching generation and directing schedule curtailments.

(b) Exceeding Interface Limit:

(i) The Party owning the applicable Flowgate shall declare an emergency and inform other RCs of the emergency.

(ii) The affected Party shall take immediate action, which may include generation redispatch, ordering immediate schedule curtailments, and if required, load shedding.

11.2.10.2 Where feasible, and if the Parties' EMS models have sufficient detail, each Party shall attempt to duplicate the other Party's power transfer evaluation in order to provide backup limit calculation in the event that the primary Party is unable accurately to determine the appropriate reliability limits.

11.2.10.3 If a new power transfer interface is determined to exist, and detailed modeling does not exist for the interface, the Parties shall coordinate to determine how their models need to be enhanced and to determine procedures for coordination in furtherance of the enhancement.

ARTICLE TWELVE - DISPUTE RESOLUTION PROCEDURES

12.1 Dispute Resolution Procedures. The Parties shall attempt in good faith to achieve consensus with respect to all matters arising under this Agreement and to use reasonable efforts through good faith discussion and negotiation to avoid and resolve disputes that could delay or impede a Party from receiving the benefits of this Agreement. These dispute resolution procedures apply to any dispute that arises from a Party's performance of, or failure to perform, this Agreement and which the applicable Parties are unable to resolve prior to invocation of these procedures. I

12.1.1 Step One. In the event a dispute arises, a Party shall give Notice of the dispute to the other Party. Within ten (10) days of such Notice, the OC shall meet and the Parties shall attempt to resolve the Dispute by reasonable efforts through good faith discussion and negotiation. In addition to a Party's OC representative, a Party shall also be permitted to bring no more than two (2) additional individuals to OC meetings held under this Step One as subject matter experts; however, all such participants must be employees of the Party they represent. In addition, each Party may bring no more than two (2) attorneys.

12.1.2 Step Two. In the event the OC is unable to resolve the dispute under Step One within twenty (20) days of the giving of Notice as provided under Section 12.1.1, and only in such event, a Party shall be entitled to invoke Step Two. A Party may

invoke Step Two by giving Notice thereof to the OC no later than thirty (30) days after the meeting of the OC under Step One. **IF A PARTY DOES NOT INVOKE STEP TWO WITHIN SUCH THIRTY (30)-DAY PERIOD, IT SHALL BE DEEMED TO HAVE WAIVED ITS RIGHTS WITH RESPECT TO THE DISPUTE, AND SHALL BE PRECLUDED FROM PURSUING ITS RIGHTS OR DEFENDING UNDER STEP TWO OR STEP THREE.** In the event a Party invokes Step Two, the OC shall, in writing, and no later than five (5) days after receipt of the Notice, refer the dispute in writing for consideration to the officers of highest authority of the Parties. Such officers shall meet in person no later than fourteen (14) days after such referral, and shall make a good faith effort to resolve the dispute. The Parties shall exchange written position papers concerning the dispute no later than forty-eight (48) hours in advance of such meeting. In the event the Parties fail to resolve the dispute under Step Two, either of the disputing Parties shall be entitled to invoke Step Three.

12.1.3 Step Three. After completion of Steps One and Two, either Party to the dispute shall have the right to file, with respect to the dispute, an action only in the United States District Court for the District of Columbia, except as provided below, and each Party submits itself to the personal jurisdiction of such Court. The Parties agree that in any such action, each Party shall stipulate to have a United States Magistrate Judge conduct any and all proceedings in the litigation in accordance with 28 U.S.C. § 636(c), and Fed. R. Civ. P. 73, and shall waive any right to a trial of the dispute by jury. The decision of the Magistrate Judge shall be final and binding on the disputing Parties, and not subject to appeal, and either Party to the dispute may seek to enforce the decision, and any resulting order or judgment by judicial proceedings. In the event the United States District Court dismisses the action for lack of subject matter jurisdiction, and notwithstanding the foregoing, a Party may file an action in any court with jurisdiction in order to obtain a resolution of the dispute, and any right of a Party to the dispute to trial of the action by jury shall be waived.

12.1.4 Exceptions. In the event of disputes involving Confidential Information, infringement or ownership of Intellectual Property or rights pertaining thereto, or any dispute where a Party seeks temporary or preliminary injunctive relief to avoid alleged immediate and irreparable harm, the procedures stated in this Article shall apply, but shall not preclude a Party from seeking such temporary or preliminary injunctive relief. If a Party seeks such judicial relief but fails to obtain it, the Party seeking such relief shall pay the reasonable attorneys' fees and costs of the other Party incurred with respect to opposing such relief.

ARTICLE THIRTEEN - RETAINED RIGHTS OF PARTIES

13.1 Parties Entitled to Act Separately. This Agreement does not create or establish, and shall not be construed to create or establish, any partnership or joint venture between the Parties. This Agreement establishes terms and conditions solely of a contractual relationship, among independent entities, to facilitate the achievement of the joint objectives described in the Agreement. The contractual relationship established

hereunder implies no duties or obligations among the Parties except as specified expressly herein. All obligations hereunder shall be subject to, and performed in a manner that complies with each Party's internal requirements; provided, however, this sentence shall not limit any payment obligation or indemnity obligation under Section 16.3.

ARTICLE FOURTEEN - EFFECTIVE DATE, IMPLEMENTATION, TERM AND TERMINATION

- 14.1 Effective Date; Implementation.** This Agreement shall become effective on the date it is executed by all Parties ("Effective Date").
- 14.2 Term.** This Agreement shall continue in full force and effect for a term of ten (10) years, and shall continue year to year thereafter, unless terminated earlier in accordance with the provisions of this Agreement.
- 14.3 Right of a Party to Terminate.**
- 14.3.1** Either Party may terminate this Agreement at any time upon not less than twelve (12) months' Notice to to the other Party.
- 14.3.2** Either Party may terminate this Agreement in accordance with Section 14.4, 14.5, or 14.6.
- 14.4. Termination Due to Regulatory Action.** In the event that FERC, or any person, takes any action to subject TVA or TVA's activities under this Agreement to FERC's jurisdiction under the Federal Power Act, either Party may terminate this Agreement upon thirty (30) days' Notice.
- 14.5 Termination Due To FERC Modification.** PJM, which is subject to jurisdiction of the FERC under the Federal Power Act, has concluded that this Agreement need not be filed with FERC under the Federal Power Act and its implementing regulations. To any extent that FERC, any other administrative or judicial body, or any other person requires this Agreement to be filed with FERC for acceptance and approval, either Party may terminate this Agreement upon thirty (30) days' Notice if FERC makes any modifications to the provisions of this Agreement.
- 14.6 Change in NERC.** This Agreement is premised on the existence of NERC, and the applicability of NERC definitions, policies, and procedures. To the extent that NERC ceases to exist in its current form, and/or is replaced with an entity with authority for reliability over the transmission systems of the Parties, the Parties shall promptly meet to determine whether to revise this Agreement to reflect the new reliability entity and the Parties' obligations in light of the authority of the new reliability entity or to terminate this Agreement.
- 14.7 Survival.** The applicable provisions of this Agreement shall continue in effect after any termination of this Agreement to provide for adjustments and payments under Article Twelve, dispute resolution, determination and enforcement of liability, and

indemnification, arising from acts or events that occurred during the period this Agreement was in effect.

- 14.8 Post-Termination Cooperation.** Following any termination of this Agreement, both Parties shall thereafter cooperate fully and work diligently in good faith to achieve an orderly resolution of all matters resulting from such termination.

ARTICLE FIFTEEN - CONFIDENTIAL INFORMATION

- 15.1 Definition.** The term “Confidential Information” shall mean: (a) all data and information, whether furnished before or after the execution of this Agreement, whether oral, written, or recorded/electronic, and regardless of the manner in which it is furnished, that is marked “Confidential” or “Proprietary” or which under all of the circumstances should be treated as confidential or proprietary; (b) any data or information deemed confidential under some other form of confidentiality agreement or tariff provided to a Party by a generator; (c) all reports, summaries, compilations, analyses, notes, or any other data or information of a Party hereto which are based on, contain, or reflect any Confidential Information; (d) applicable material deemed Confidential Information pursuant to the PJM Data Confidentiality Regional Stakeholder Group; and (e) any data and information which, if disclosed by a transmission function employee of a utility regulated by the FERC to a market function employee of the same utility system, other than by public posting, would violate the FERC’s Standards of Conduct set forth in 18 C.F.R. §§ 37.1-37.8 and the PJM’s Standards of Conduct on file with the FERC and TVA’s Standard of Conduct. The Parties agree that Confidential Information constitutes commercially sensitive and proprietary trade secret information.

- 15.1.1 Confidential Data Exchange.** The Parties agree that various components of the data exchanged under Section 4.1, including data exchanged under, § 4.1.4.10 (a) (generation Scheduled Outages), 4.1.4.10(c) (notifications of short term forced outages), and data exchanged under § 5.1.1 (12 month schedule for Scheduled Outages), are Confidential Information:

- (a) The Party receiving the Confidential Information shall treat the information in the same confidential manner as its Governing Documents require it treat the confidential information of its own members and market participants.
- (b) The receiving Party shall not release the producing Party’s Confidential Information until expiration of the time period controlling the producing Party’s disclosure of the same information, as such period is described in the producing Party’s Governing Documents from time to time. As of the Effective Date, this period is six (6) months with respect to bid or pricing data, and seven (7) calendar days for transmission data after the event ends.
- (c) All other prerequisites applicable to the producing Party’s release of such Confidential Information have been satisfied as determined by the producing Party.

- 15.2 Protection.** During the course of the Parties' performance under this Agreement, a Party may receive or become exposed to Confidential Information. Except as set forth herein, the Parties agree to keep in confidence, and not to copy, disclose, or distribute any Confidential Information or any part thereof, without the prior written permission of the issuing Party. In addition, each Party shall ensure that its employees, its agents, its subcontractors, and its subcontractors' employees, and agents to whom Confidential Information is given or exposed, agree to be bound by the terms and conditions contained herein. Each Party shall be liable for any breach of this Article by its employees, its agents, its subcontractors, and its subcontractors' employees and agents.
- 15.3 Scope.** This obligation of confidentiality shall not extend to data and information that, at no fault of a recipient Party, is or was: (a) in the public domain or generally available or known to the public; (b) disclosed to a recipient by a non-Party who had a legal right to do so; (c) independently developed by a Party or known to such Party prior to its disclosure hereunder; and (d) which is required to be disclosed by subpoena, law, or other directive of a Governmental Authority.
- 15.4 Standard of Care.** Each Party shall protect Confidential Information from disclosure, dissemination, or publication. Regardless of whether a Party is subject to the jurisdiction of the FERC under the Federal Power Act, and regardless of whether a Party is a RTO, each Party agrees to restrict access to all Confidential Information to only those persons authorized to view such information (a) by the FERC's Standards of Conduct, 18 C.F.R. §§ 37.1-37.8 or, if more restrictive, (b) by such Party's board resolutions, tariff provisions, or other internal policies governing access to, and the sharing of, energy market or transmission system information.
- 15.5 Required Disclosure.** If a Governmental Authority requests or requires a Party to disclose any Confidential Information, such Party shall provide the supplying Party with prompt Notice of such request or requirement so that the supplying Party may seek an appropriate protective order or other appropriate remedy or waive compliance with the provisions of this Agreement. Notwithstanding the absence of a protective order or a waiver, a Party shall disclose only such Confidential Information, which it is legally required to disclose. Each Party shall use reasonable efforts to obtain reliable assurances that confidential treatment will be accorded to Confidential Information required to be disclosed.

In response to any Freedom of Information Act (FOIA) request for information received from or relating to a Party which has been designated Confidential Information, TVA shall evaluate the request and determine the applicability of any FOIA exemptions. TVA shall consult with the affected Party regarding the applicability of the FOIA exemptions, including 5 U.S.C. § 552. Pursuant to its responsibilities under the FOIA, TVA must make the final determination regarding whether the information requested is legally exempt from disclosure under the FOIA, and shall notify PJM in advance of the release of any Confidential Information as part of the response to a FOIA request.

If a Party is required to disclose any Confidential Information (the Disclosing Party) under this Section, a Party supplying such Confidential Information (the Supplying Party) shall have the right to immediately suspend supplying such Confidential Information to

the Disclosing Party. In that event, the Parties shall meet as soon as practicable in an effort to resolve any and all issues associated with the required disclosure of such Confidential Information, and the likelihood of additional disclosures of such Confidential Information. If the Parties are unable to resolve those issues within ten (10) days, notwithstanding Section 14.3, the Supplying Party shall have the right to terminate this Agreement immediately.

15.6 Return of Confidential Information. All Confidential Information provided by the supplying Party shall be returned by the receiving Party to the supplying Party promptly upon request. Upon termination or expiration of this Agreement, a Party shall use reasonable efforts to destroy, erase, delete, or return to the supplying Party any and all written or electronic Confidential Information. In no event shall a receiving Party retain copies of any Confidential Information provided by a supplying Party.

15.7 Equitable Relief. Each Party acknowledges that remedies at law are inadequate to protect against breach of the covenants and agreements in this Article, and hereby in advance agrees, without prejudice to any rights to judicial relief that it may otherwise have, to the granting of equitable relief, including injunction, in the supplying Party's favor without proof of actual damages. In addition to the equitable relief referred to in this Section, a supplying Party shall only be entitled to recover from a receiving Party any and all gains wrongfully acquired, directly or indirectly, from a receiving Party's unauthorized disclosure of Confidential Information.

ARTICLE SIXTEEN - ADDITIONAL PROVISIONS

16.1 Unauthorized Transfer of Third-Party Intellectual Property. In the performance of this Agreement, no Party shall transfer to the other Party any Intellectual Property, the use of which by that Party would constitute an infringement of the rights of any non-Party. In the event such transfer occurs, whether or not inadvertent, the transferring Party shall, promptly upon learning of the transfer, provide Notice to the receiving Party and upon receipt of such Notice the receiving Party shall take reasonable steps to avoid claims and mitigate losses.

16.2 Intellectual Property Developed Under This Agreement. If during the term of this Agreement, the Parties mutually develop any new Intellectual Property that is reduced to writing, the Parties shall negotiate in good faith concerning the ownership and licensing of such Intellectual Property.

16.3 Indemnification. Each Party shall defend, indemnify, and hold the other Party harmless from all actual losses, damages, liabilities, claims, expenses, causes of action, and judgments (collectively, "Losses"), brought or obtained by any non-Party against such Party, only to the extent that such Losses arise directly from:

- (a) Gross negligence, recklessness, or willful misconduct of such Party or any of its agents or employees, in the performance of this Agreement, except to the extent the Losses arise (i) from gross negligence, recklessness, willful misconduct or breach of contract or law by the other Party or such other Party's agents or

employees, or (ii) as a consequence of strict liability imposed as a matter of law upon the other Party, or such other Party's agents or employees;

- (b) Any claim that such Party violated any copyright, patent, trademark, license, or other intellectual property right of a non-Party in the performance of this Agreement;
- (c) Any claim arising from the transfer of Intellectual Property in violation of Section 16.1; or
- (d) Any claim that such Party caused bodily injury to an employee of the other Party due to gross negligence, recklessness, or willful conduct of such Party.

16.4 Limitation of Liability. Except as set forth in this Article: (a) no Party shall be liable to the other Party, directly or indirectly, for any damages or losses of any kind sustained due to any failure to perform its obligations under this Agreement, unless such failure to perform was malicious or reckless; and (b) any liability of a Party to the other Party shall be limited to direct damages, and no lost profits, damages to compensate for lost goodwill, consequential damages, or punitive damages shall be sought or awarded.

16.5 Permitted Assignments. This Agreement may not be assigned by either Party except: (a) with the written consent of the non-assigning Party, which consent may be withheld in such Party's absolute discretion; and (b) in the case of a merger, consolidation, sale, or spin-off of substantially all of a Party's assets. In the case of a merger, consolidation, sale, reorganization, or spin-off by a Party, such Party shall assure that the successor or purchaser adopts this Agreement, and the other Party shall be deemed to have consented to such adoption.

16.6 Liability to Non-Parties. Nothing in this Agreement, whether express or implied, is intended to confer any rights or remedies under or by reason of this Agreement on any person or entity that is not a Party or a permitted successor or assign; provided, that nothing in this Section shall affect the rights or obligations of any Reciprocal Entity under a Reciprocal Coordination Agreement.

16.7 Force Majeure. No Party shall be in breach of this Agreement to the extent and during the period that such Party's performance is made impracticable by any unanticipated cause or causes beyond such Party's control, and without such Party's fault or negligence, which may include, but are not limited to, any act, omission, or circumstance occasioned by or in consequence of any act of God, labor dispute, act of the public enemy, war, insurrection, riot, fire, storm or flood, explosion, breakage or accident to machinery or equipment, or curtailment, order, regulation or restriction imposed by a Governmental Authority. Upon the occurrence of an event considered by a Party to constitute a *force majeure* event, such Party shall use reasonable efforts to endeavor to continue to perform its obligations as far as reasonably practicable and to remedy the event, provided that this Section shall not require either Party to settle any strike or labor dispute. A Party claiming a *force majeure* event shall notify the other Party in writing immediately, and in no event later than forty-eight (48) hours after the occurrence of the *force majeure* event. The foregoing notwithstanding, the occurrence of a cause under this

Section shall not excuse a Party from making any payment otherwise required under this Agreement.

- 16.8 Amendment.** No amendment of or modification to this Agreement shall be made or become enforceable except by a written instrument duly executed by all of the Parties.
- 16.9 Headings.** The headings used for the Articles and Sections of this Agreement are for convenience and reference purposes only, and shall not be construed to modify, expand, limit, or restrict the provisions of this Agreement.
- 16.10 Counterparts.** This Agreement may be executed in any number of counterparts, each of which shall be an original, but all of which together will constitute one instrument, binding upon the Parties hereto, notwithstanding that both Parties may not have executed the same counterpart.
- 16.11 Notices.** A notice (“Notice”) shall be effective only if in writing and delivered by: hand; reputable overnight courier; United States mail; or telefacsimile. Electronic mail is not effective Notice. Notice shall be deemed to have been given: (a) when delivered to the recipient by hand, overnight courier, or telefacsimile or (b) if delivered by United States mail, on the postmark date. Notice shall be addressed as follows:

PJM: Michael J. Kormos
 Executive Vice President, Operations
 PJM Interconnection, L.L.C.
 2750 Monroe Boulevard
 Valley Forge Corporate Center
 Audubon, PA 19403
 Tel: (610) 666-4377
 Fax: (610) 666-4281

TVA:
 Timothy E. Ponseti
 Vice President, Transmission Operations & Power Supply
 Tennessee Valley Authority
 1101 Market Street, MR 1 B-C
 Chattanooga, TN 37402-2801
 Tel: (423) 751-2699
 Fax: (423) 751-7116

A Party may change its designated recipient of Notices, or its address, from time to time, by giving Notice of such change.

- 16.12 Governing Law.** This Agreement and the rights and duties of the Parties relating to this Agreement shall be governed by and construed in accordance with the Federal laws of the United States of America, including but not limited to federal, and general contract law. Subject to Article Twelve (Dispute Resolution).

16.13 Prior Agreements; Entire Agreement. All prior agreements by the Parties relating to the matters contemplated by this Agreement, whether written or oral, are superseded by this Agreement, and shall be of no further force or effect. For the avoidance of doubt, as provided under Section 3.2, this Agreement does not supersede the JOA.

PJM INTERCONNECTION, LLC

By:



Signature

Michael J. Kormos

Michael J. Kormos

Executive Vice President, Operations

TENNESSEE VALLEY AUTHORITY

By:



Signature

Jacinda B. Woodward

Jacinda B. Woodward

Senior Vice President - Transmission

ATTACHMENT 1

**Congestion
Management
Process
(CMP)
MASTER**

**Baseline
Version 1.9**

June 1, 2014

Executive Summary

This Congestion Management Process¹ document provides significant detail in the areas of Market Flow Calculation. These additional details are the result of discussions between multiple Operating Entities.

As Operating Entities expand and implement their respective markets, one of the primary seams issues that must be resolved is how different congestion management methodologies (market-based and traditional) will interact to ensure that parallel flows and impacts are recognized and controlled in a manner that consistently ensures system reliability. This proposed solution will greatly enhance current Interchange Distribution Calculator (IDC) granularity by utilizing existing real-time applications to monitor and react to Flowgates external to an Operating Entity's footprint.

In brief, the process includes the following concepts:

- Participating Operating Entities will agree to observe limits on an extensive list of coordinated external Flowgates.*
- Like all Control Areas (CA), Market-Based Operating Entities will have Firm Market Flows upon those Flowgates.*
- Market-Based Operating Entities will determine Firm Market Flows and constrain their operations to limit Firm Market Flows on the Coordinated Flowgates to no more than the calculated Firm Flow Limit established in the analysis.*
- In real-time, Market-Based Operating Entities will calculate and monitor one-hour ahead projected and actual flows.*
- Market-Based Operating Entities will post to the IDC the actual and the one-hour ahead projected market flow, consisting of the Firm Market Flow and the additional Non-Firm Market Flow, for both internal and external Coordinated Flowgates.*
- Market-Based Operating Entities will provide to the IDC detailed representation of their marginal units, so that the IDC can continue to effectively compute the effects of all tagged transactions regardless of the size of the market area. These tagged transactions will include transactions into the market, transactions out of the market, transactions through the market, and tagged grandfathered transactions within the market.*

¹ Capitalized terms that are not defined in this Attachment 1 shall have the meaning set forth in the body, appendices, and attachments of the *Joint Reliability Coordination Agreement Between Tennessee Valley Authority ("TVA") and PJM Interconnection, L.L.C. ("PJM")*

- *When there is a Transmission Loading Relief (TLR) 3a request or higher called on a Coordinated Flowgate, and the Market-Based Operating Entity's actual/one-hour ahead projected Market Flows exceed the Firm Flow Limits, Market-Based Operating Entities will respond to their relief obligations by redispatching their systems in a manner that is consistent with how non-market entities respond to their share of Network and Native Load (NNL) relief obligations per the IDC congestion management report.*
- *Because the IDC will have the real-time/one-hour ahead projected flows throughout the Market-Based Operating Entity's system (as represented by the impacts upon various Coordinated Flowgates), the effectiveness of the IDC will be greatly enhanced*
- *The above processes refer to the "Congestion Management" portion of the paper, which will be implemented by Market-Based Operating Entities.*
- *Additional entities may choose to enter into similar Reciprocal Coordination Agreements that describe how Available Transfer Capability (ATC)/Available Flowgate Capability (AFC), Firm Flows, and outage maintenance will be coordinated on a forward basis.*
- *The complete process will allow participating Operating Entities to address the reliability aspects of congestion management seams issues between all parties whether the seams are between market to non-market operations or market-to-market operations.*

Change Summary

Generate baseline Congestion Management Process (CMP) document based on CMP documents executed by:

- Manitoba Hydro and the Midwest ISO
- MAPPCOR and the Midwest ISO
- The Midwest ISO and PJM
- PJM and TVA
- The Midwest ISO and SPP

The document also includes subsequent changes agreed upon by a majority of the Congestion Management Process Council (CMPC). For items which are specific to a limited number of agreements, the CMP members have used an approach of documenting these unique items in separate appendices rather than in the base document. The CMPC members reserve all rights with respect to the different options identified in the appendices attached hereto without any obligation to adopt or support such options. The CMPC members reserve the right to oppose any position taken by another CMPC member in a FERC filing or otherwise with respect to the choice of options listed in the appendices. Nothing contained herein shall be construed to indicate the support or agreement by the CMPC members to an option presented in the appendices.

Revision 1.1 (November 30, 2007)

Per FERC Order ER07-1417-000, in the “Forward Coordination Processes” section 6.6 added the word “outage” between “unit” and “scheduling” in the following sentence, “Market-Based Operating Entities will use the Flowgate limit to restrict unit outage scheduling for a Coordinated Flowgate when maintenance outage coordination indicates possible congestion and there is recent TLR activity on a Flowgate.”

Revision 1.2 (May 2, 2008)

The Market Flow Threshold is changing from 3% to 5%. The NERC Standards Committee approved changing the Market Flow Threshold for the field test at their April 10, 2008 meeting.

Revision 1.3 (July 16, 2008)

Per FERC Order issued in Docket Nos. ER08-884-000 and ER08-913-000, *Appendix H (Market Flow Threshold Field Test Terms And Conditions)* was added.

Revision 1.4 (October 31, 2008)

The percentages were changed in Sections 4.4 (*Firm Market Flow Calculation Rules*) and 5.5 (*Market-Based Operating Entity Real-time Actions*) to be consistent with changes made under Revision 1.2. *Appendix H – Market Flow Threshold Field Test Terms And Conditions* was updated to reflect the NERC approved Market Flow Threshold Field Test extension to October 31, 2009.

Revision 1.5 (December 18, 2008)

Updated Section 5.2 (*Quantify and Provide Data for Market Flow*) and *Appendix B – Determination of Marginal Zone Participation Factors* to support changes to the manner in which the Midwest ISO uses marginal zones and submits marginal zone information to the IDC.

Revision 1.6 (February 19, 2009)

Appendix H – Market Flow Threshold Field Test Terms And Conditions was updated to reflect that Midwest ISO no longer has a contractual obligation to observe a 0% threshold for Midwest ISO market flows on flowgates where both MAPP and the Midwest ISO are reciprocal.

Revision 1.7

Skipped in order to match other CMP revision numbers.

Revision 1.8

Skipped in order to match other CMP revision numbers.

Revision 1.9 (June 1, 2014)

Applied updates based on the results of the Market Flow Threshold Field Test including clarifications that allocations are calculated down to zero percent. Changes have been applied to the *Executive Summary, Section 4.1 Market Flow Determination, Section 4.4 Firm Market Flow Calculation Rules, Section 5.5 Market-Based Operating Entity Real-time Actions, Section 6.6 Forward Coordination Processes, Section 6.6.3 Limiting Firm Transmission Service, Section 6.7 Sharing or Transferring Unused Allocations, and Appendix H – Application of Market Flow Threshold Field Test Conditions.*

Modified to incorporate the revisions to the PJM-MISO JOA, including revisions to Attachments 2 and 3, submitted as part of the Settlement Agreement and Offer of Settlement in Docket Nos. EL10-45-000, EL10-46-000, and EL10-60-000.

Table of Contents

SECTION 1 – INTRODUCTION

1.1 Problem Definition

- 1.1.1 THE NATURE OF ENERGY FLOWS
- 1.1.2 GRANULARITY IN THE IDC
- 1.1.3 REDUCED DATA AND GRANULARITY COARSENESS
- 1.1.4 ACCOUNTING FOR LOOP FLOWS
- 1.1.5 CONCLUSION

1.2 Process Scope and Limitations

- 1.2.1 VISION STATEMENT
- 1.2.2 PROCESS SCOPE

1.3 Goals and Metrics

1.4 Assumptions

SECTION 2 – PROCESS OVERVIEW

2.1 Summary of Process

SECTION 3 – IMPACTED FLOWGATE DETERMINATION

3.1 Flowgates

3.2 Coordinated Flowgates

- 3.2.1 FLOWGATE STUDIES
- 3.2.2 DISPUTED FLOWGATES
- 3.2.3 THIRD PARTY REQUEST FLOWGATE ADDITIONS
- 3.2.4 FREQUENCY OF COORDINATED FLOWGATE DETERMINATION
- 3.2.5 DYNAMIC CREATION OF COORDINATED FLOWGATES

SECTION 4 – MARKET-BASED OPERATING ENTITY FLOW CALCULATIONS: MARKET FLOW, FIRM MARKET FLOW, AND NON-FIRM MARKET FLOW

4.1 Market Flow Determination

4.2 Firm Flow Determination

4.3 Determining the Firm Flow Limit

4.4 Firm Market Flow Calculation Rules

SECTION 5 – MARKET-BASED OPERATING ENTITY CONGESTION MANAGEMENT

5.1 Calculating Market Flows

5.2 Quantify and Provide Data for Market Flow

5.3 Day-Ahead Operations Process

5.4 Real-time Operations Process – Operating Entity Capabilities

5.5 Market-Based Operating Entity Real-time Actions

SECTION 6 – RECIPROCAL OPERATIONS

6.1 Reciprocal Coordinated Flowgates

6.2 The Relationship Between Coordinated Flowgates and Reciprocal Coordinated Flowgates

6.3 Coordination Process for Reciprocal Flowgates

6.4 Calculating Historic Firm Flows

6.5 Recalculation of Initial Historic Firm Flow Values and Ratios

6.6 Forward Coordination Processes

6.6.1 DETERMINING FIRM TRANSMISSION SERVICE IMPACTS

6.6.2 RULES FOR CONSIDERING FIRM TRANSMISSION SERVICE

6.6.3 LIMITING FIRM TRANSMISSION SERVICE

6.7 Sharing or Transferring Unused Allocations

6.7.1 GENERAL PRINCIPLES

6.7.2 PROVISIONS FOR SHARING OR TRANSFERRING OF UNUSED ALLOCATIONS

6.8 Market-Based Operating Entities Quantify and Provide Data for Market Flow

6.9 Real-time Operations Process for Market-Based Operating Entities

6.9.1 MARKET-BASED OPERATING ENTITY CAPABILITIES

6.9.2 MARKET-BASED OPERATING ENTITY REAL-TIME ACTIONS

SECTION 7 – APPENDICES

Appendix A – Glossary

Appendix B – Determination of Marginal Zone Participation Factors

Appendix C – Flowgate Determination Process

Appendix D – Training

Appendix E – Reserved

Appendix F - FERC RCF Dispute Resolution

Appendix G - Allocation Adjustment for New Transmission Facilities and/or Designated Network Resources (or Reserved)

Appendix H – Application of Market Flow Threshold Field Test Conditions0

Section 1 – Introduction

It is the intention of the Reciprocal Entities to utilize the processes within this document. It is further the intention to develop this process in a way that will allow other regional entities with similar concerns to utilize the concepts within this process to aid in the resolution of their own seams issues.

1.1 Problem Definition

1.1.1 The Nature of Energy Flows

Energy flows are distinctly different from the manner in which the energy commodity is purchased, sold, and ultimately scheduled. In the current practice of “contract path” scheduling, schedules identify a source point for generation of energy, a series of wheeling agreements being utilized to transport that energy, and a specific sink point where that energy is being consumed by a load. However, due to the electrical characteristics of the Eastern Interconnection, energy flows are more dispersed than what is described within that schedule. This disconnect becomes of concern when there is a need to take actions on contract-path schedules to effect changes on the physical system (for example, the curtailment of schedules to relieve transmission constraints).

In the Eastern Interconnection, much of this concern has been addressed through the use of the North American Electric Reliability Corporation (NERC) and/or North American Energy Standards Board (NAESB) TLR process. Through this process, Reliability Coordinators utilize the IDC to determine appropriate actions to provide that relief. The IDC bases its calculations on the use of transaction tags: electronic documents that specify a source and a sink, which can be used to estimate real power flows through the use of a network model. In order to change flows, the IDC is given a particular constraint and a desired change in flows. The IDC returns back all source to sink transactions that contribute to that constraint and specifies schedule changes to be made that will effect that change in flows.

In other parts of the Eastern Interconnection, however, the use of centralized economic dispatch results in a solution that does not focus on changing entire transactions (effectively redispatching through the use of imbalance energy), but rather redispatch itself. In this procedure, the party attempting to provide relief does not need to know that a balanced source to sink transaction should be adjusted; rather, they are aware of a net generation to load balance and the impacts of different generators on various constraints. Bid-based security constrained central dispatch based on Locational Marginal Pricing is a regional implementation of this practice.

Currently, these two practices are somewhat incompatible. Due to the electrical characteristics of the Interconnection and geographic scope of the regions, this incompatibility has been of limited concern. However, regional market expansion has begun to draw attention to this operational disjoint, as the expansion itself exacerbates the negative effects of the incompatibility.

1.1.2 Granularity in the IDC

The IDC uses an approximation of the Interconnection to identify impacts on a particular transmission constraint that are caused by flows between Control Areas. This approximation allows for a Reliability Coordinator to identify tagged transactions with specific sources and sinks that are contributing to the constraint. While tagged transactions may specify sources and sinks in a very specific manner, the IDC in general cannot respect this detail, and instead

consolidates the impacts of several generators and loads into a homogenous representation of the impacts of a single Control Area. This is referred to as the *granularity* of the IDC. Current granularity is typically defined to the Control Area level; finer granularity is present in certain special situations as deemed necessary by NERC.

1.1.3 Reduced Data and Granularity Coarseness

As centrally dispatched energy markets expand their footprint, two related changes occur with regard to the above process. In some cases, data previously sent to the IDC is no longer sent due to the fact that it is no longer tagged. In others, transactions remain tagged, but the increased market footprint results in an increase in granularity coarseness within the IDC; that is, the apparent Control Area boundary becomes the same as the market boundary so that what had been historically 30 or more Control Areas now appears as one.

In the first change, transactions contained entirely within the market footprint are considered to be utilizing network service (even when the market spans multiple Control Areas). As such, there is no requirement for them to be tagged (or such requirement is waived by NERC), and therefore, no requirement that they be sent to the IDC. This is of concern from a reliability perspective, as the IDC will no longer have a large pool of transactions from which to provide relief, although the energy flows may remain consistent with those prior to the market expansion. In other words, flows subject to TLR curtailment prior to the market expansion are no longer available for that process.

In the second change, the expansion of the footprint itself results in a dilution of the approximation utilized by the IDC. When a market region is relatively small (or isolated), the Control Area to Control Area approximation of that region's impact on transmission constraints is acceptable; actions within the market footprint generally have a similar and consistent impact on all transmission facilities outside the footprint. However, when the market footprint expands significantly, and is co-mingled with non-market Control Areas, the ability to utilize the historic approximation of electrically representative flows fails to effectively predict energy flow. Impacts on external facilities can vary significantly depending on the dispatch of the resources within the market footprint. With regard to the IDC, this information is effectively lost within the expanded footprint, and results in an increase in the level of granularity coarseness, or a "loss of granularity."

1.1.4 Accounting for Loop Flows

The processes for accounting for loop flows caused by uses of the transmission system between Control Areas are different under a market environment. Absent a market, loop flows from Transmission Service reservations between Control Areas are identified and accounted for by importing transmission reservations from surrounding systems. Under a market environment, the market will not have explicit transmission reservations for evolving market dispatch conditions between market Control Areas. Thus, a mechanism for accounting for anticipated Market Flows on non-market systems is necessary.

1.1.5 Conclusion

The net effect of these changes is that reliability must be managed through different processes than those used before the market region's expansion. While relief can still be requested using the current process, both the ability to predict the effectiveness of a curtailment to provide that relief and the general pool of transactions available for curtailment are reduced. This congestion management process (CMP) offers a strategy for eliminating this concern through a process that provides more information (finer granularity) to the NERC IDC for the market area. This new congestion management process will ensure that reliability is not adversely affected as markets expand by providing information and relief opportunities previously unavailable to the IDC.

1.2 Process Scope and Limitations

1.2.1 Vision Statement

As Operating Entities become Market-Based Operating Entities, and expand their various markets, one of the primary seams issues that must be resolved is how different congestion management methodologies (market-based and traditional TLR) will interact to ensure parallel flows and impacts are recognized and controlled in a manner that consistently ensures system reliability and equitability. Reliability Coordinators can mandate emergency procedures to maintain safe operating limits, however, without coordination agreements that maintain flow limits in advance, the market would become volatile and the burden for relieving excess flow would ignore the economics of the entities which would be required to redispatch. For these entities, this process will offer a manner in which Market-Based Operating Entities can coordinate parallel flows with Operating Entities that have not yet or do not contemplate implementing markets. This process will provide more proactive management of transmission resources, more accurate information to Reliability Coordinators, and more candidates for providing relief when reliability is threatened due to transmission overload conditions.

1.2.2 Process Scope

This process has been written specifically with the goal of coordinating seams between Reciprocal Entities and their respective neighbors.

1.3 Goals and Metrics

This document focuses on a solution to meet the following goals and requirements:

1. Develop a congestion management process whereby transmission overloads can be prevented through a shared and effective reduction in Flowgate or constraint usage by Reciprocal Entities and adjoining Reliability Coordinators.
2. Agree on a predefined set of Flowgates or constraints to be considered by all Reciprocal Entities, and a process to maintain this set as necessary.
3. Determine the best way to calculate flow due to market impacts on a defined set of Flowgates.
4. Develop Reciprocal Coordination Agreements that establish how each Operating Entity will consider its own Flowgate or constraint usage as well as the usage of other Operating Entities when it determines the amount of Flowgate or constraint capacity remaining. This process will include both operating horizon determination as well as forward looking capacity allocation.
5. Develop a procedure for managing congestion when Flowgates are impacted by both tagged and untagged energy flow.
6. Develop a procedure for determining the priorities of untagged energy flows (created through parallel flows from the market).
7. Agree on steps to be taken by Operating Entities to unload a constraint on a shared basis.
8. Determine whether procedure(s) for managing congestion will differ based on where the Flowgate is located (*i.e.*, inside Reciprocal Entity A, inside Reciprocal Entity B, or outside both Reciprocal Entity A and Reciprocal Entity B).
9. Confirm that the solution will be equitable, transparent, auditable, and independent for all parties.
10. Develop methodology to preserve and accommodate grandfathered transmission rights, contract rights, and other joint-use agreements.
11. Develop methodology to address changes in Total Transfer Capability (TTC), such as future system topology changes, new Designated Network Resources (DNRs), facility updates/derates, prior outage limitations, etc., with respect to Allocation implications.
12. Develop a methodology for releasing Allocations if other parties do not join the process or if there is ATC going unused.

1.4 Assumptions

The processes set forth in this document were based on the following assumptions:

- Point-to-point schedules sinking in, sourcing from, or passing through a Market-Based Operating Entity will be tagged.
- The IDC or a similar repository of schedules is needed at the Interconnection's current state and for the foreseeable future.
- The Market-Based Operating Entity can compute the impacts of the untagged market dispatch on the Flowgates as currently required by the IDC.
- The Market-Based Operating Entity's Energy Management System (EMS) has the capability to monitor and respond to real-time and projected flows created by its real-time dispatch.
- The Reliability Coordinator of the area in which a Flowgate exists will be responsible for monitoring the Flowgate, determining any amount of relief needed, and entering the required relief in the IDC.
- The IDC has been modified to accept the calculated values of the impact of real-time generation in order to determine which schedules require curtailment in conjunction with the required Market-Based Operating Entity's redispatch.
- The IDC can calculate the total amount of MW relief required by the Market-Based Operating Entity (schedule curtailments required plus the relief provided by redispatch).

2.1 Summary of Process

In order to coordinate congestion management, a bridge must be established that provides for comparable actions between Operating Entities. Without such a bridge, it is difficult, if not impossible, to ensure reliability and system coordination in an efficient and equitable manner. To effect this coordination of congestion management activities, we propose a methodology for determining both firm and non-firm flows resulting from Market-Based Operating Entity dispatch on external parties' Flowgates.

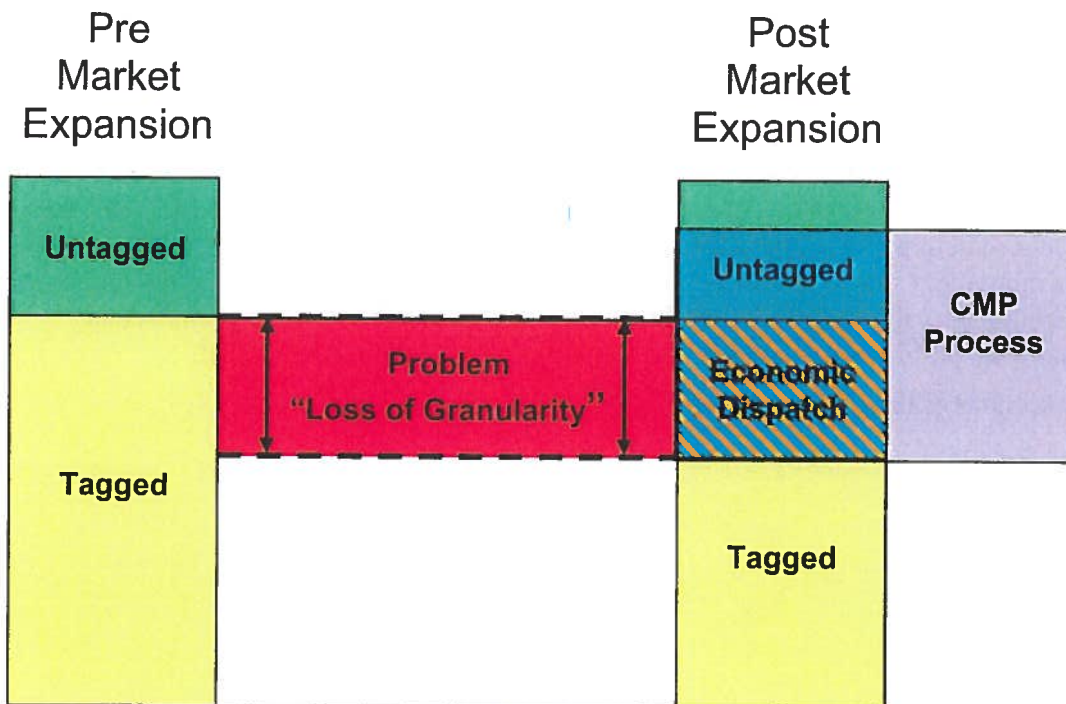

Market Flows are defined as the calculated energy flows on a specified Flowgate as a result of dispatch of generating resources serving market load within a Market-Based Operating Entity's market. (Note: For the purposes of the Reciprocal Coordination process discussed later, Firm Transmission Service (7F) will be combined with the untagged firm component of Market Flows in the calculation of Historic Firm Flow. The Historic Firm Flow is described later in this document).

Market Flows can be divided into Firm Market Flows and Non-Firm Market Flows. Firm Market Flows are considered as firm use of the transmission system for congestion management purposes and will be curtailed on a proportional basis with other firm uses during periods of firm curtailments and are equivalent to Firm Transmission Service. Non-Firm Market Flows are considered as non-firm use of the transmission system for congestion management purposes and will be curtailed on a proportional basis with other non-firm uses during periods of non-firm curtailments and are equivalent to non-firm Transmission Service. As such, Reliability

Coordinators can request Market-Based Operating Entities to provide relief under TLR based on these transmission priorities.

By applying the above philosophy to the problem of coordinating congestion management, we can determine not only the impacts of a Market-Based Operating Entity's dispatch on a particular Flowgate; we can also determine the appropriate firmness of those flows. This results in the ability to coordinate both proactive and reactive congestion management between operating entities in a way that respects the current TLR process, while still allowing for the flexibility of internal congestion management based on market prices.

There are two areas that must be defined in order for this process to work effectively:

- **Coordinated Flowgate Definition.** In order to ensure that impacts of dispatch are properly recognized, a list of Flowgates must be developed around which congestion management may be effected and coordination can be established.
- **Congestion Management.** By coordinating congestion management efforts and enhancing the TLR process to recognize both untagged energy flows and data of finer granularity, we can ensure that when TLR is called, the appropriate non-firm flows are reduced before Firm Flows. This coordination will result in a reduction of TLR 5 events, as more relief will be available in TLR 3 to mitigate a constraint. This is accomplished through the calculation of flows due to economic dispatch, as well as by providing marginal unit information to aid in interchange transaction management.

The next sections of this document discuss each of these areas in detail.

Section 3 – Impacted Flowgate Determination

3.1 Flowgates

Flowgates are facilities or groups of facilities that may act as significant constraint points on the system. As such, they are typically used to analyze or monitor the effects of power flows on the bulk transmission grid. Operating Entities utilize Flowgates in various capacities to coordinate operations and manage reliability. For the purpose of this process, there are three kinds of Flowgates: AFC Flowgates, which are defined in Appendix A, Coordinated Flowgates (CFs), which are defined below, and Reciprocal Coordinated Flowgates (RCFs), which are defined in “Reciprocal Operations” Section 6. A diagram illustrating how these three categories of Flowgates are determined is included as Appendix C.

3.2 Coordinated Flowgates

An Operating Entity will conduct sensitivity studies to determine which Flowgates are significantly impacted by the flows of the Operating Entity's Control Zones (historic Control Areas that existed in the IDC). An Operating Entity identifies these Flowgates by performing the following four studies to determine which Flowgates the Operating Entity will monitor and help control. A Flowgate passing any one of these studies will be considered a Coordinated Flowgate. Only AFC Flowgates will be eligible for consideration as Coordinated Flowgates. A Flowgate must have AFCs computed and these AFCs must be used to sell Transmission Service in order to be a Coordinated Flowgate.

An Operating Entity may also specify additional Flowgates that have not passed any of the four studies to be Coordinated Flowgates. For Flowgates on which the Operating Entity expects to utilize the TLR process to protect system reliability, such specification is required. For a list of Coordinated Flowgates between Reciprocal Entities, please see each Reciprocal Entity's Open Access Same-Time Information System (OASIS) website.

Coordinated Flowgates are identified to determine which Flowgates an entity impacts significantly. This set of Flowgates may then be used in the congestion management processes and/or Reciprocal Operations defined in this document.

When performing the four Flowgate studies, a 5% threshold will be applied on an absolute basis without regard to the positive or negative sign of the impact. Use of a 5% threshold in the studies may not capture all Flowgates that experience a significant impact due to market operations. The Operating Entities have agreed to adopt a lower threshold at the time NERC and/or NAESB implements the use of a lower threshold in the TLR process.

3.2.1 Flowgate Studies

Study 1) – IDC Base Case

(using the IDC tool)

This is a one time study done before Control Area consolidation. The IDC can provide a list of Flowgates for any user-specified Control Area whose GLDF (Generator to Load Distribution Factor (NNL)) impact is 5% or greater. The Operating Entity will use the IDC capabilities to develop a preliminary set of Flowgates. This list will contain Flowgates that are impacted by 5% or greater by the Control Areas that will be joining the Operating Entity as Control Zones/areas. OTDF Flowgates will be analyzed with the contingent element out of service. Using the historic Control Area representation in the IDC (i.e., pre-Operating Entity expansion), if any one generator has a GLDF (Generator to Load Distribution Factor) greater than 5% as determined by the IDC, this Flowgate will be considered a Coordinated Flowgate.

Study 2) – IDC PSS/E Base Case

(no transmission outages – offline study)

For those situations where one or more CAs are being, or have been incorporated into an Operating Entity's footprint after the freeze date, there will be a generator analysis performed

to determine which Flowgates impacted by those CAs will be included in the list of Coordinated Flowgates. In order to confirm the IDC analysis, and to provide a better confidence that the Operating Entity has effectively captured the subset of Flowgates upon which its generators have a significant impact, an offline study utilizing MUST capabilities will be conducted. The Operating Entity will perform off-line studies (using the IDC PSS/E base case) to confirm the IDC analysis. Study 1 and Study 2 are separate studies. There is no requirement that a Flowgate must pass both studies in order to be coordinated.

Study 3) – IDC PSS/E Base Case

(transmission outage - offline study)

For those situations where one or more CAs are being, or have been incorporated into an Operating Entity's footprint after the freeze date, there will be a Flowgate analysis performed to determine which Flowgates impacted by those CAs will be included in the list of Coordinated Flowgates. The Operating Entity, in consultation with affected operating authorities, will perform a prior outage analysis, including both internal and external outages. The Flowgates determined using Study 2 or 4 that have a 3% to 5% distribution factor will be analyzed against prior outage conditions. This study will be performed offline utilizing MUST capabilities. If any Flowgates with a 3% to 5% distribution factor from Study 2 or 4 are impacted by 5% or more from a prior outage condition (Line Outage Distribution Factor LODF) from this method, the Flowgate will be added to the list of Coordinated Flowgates.

Study 4) – Control Area to Control Area

For those situations where one or more CAs are being, or have been incorporated into an Operating Entity's footprint after the freeze date, there will be a Flowgate analysis performed to determine which Flowgates impacted by those CAs will be included in the list of Coordinated Flowgates. The Operating Entity will analyze transactions between each new CA and the existing market, as well as between each CA/CA permutation (if more than one CA is moving into the footprint). OTDF Flowgates will be analyzed with the contingent element out of service. This study will use Transfer Distribution Factors (TDFs) from the IDC and offline studies utilizing MUST capabilities. Flowgates that are impacted by greater than 5% as determined by the IDC will be considered a Coordinated Flowgate.

3.2.2 Disputed Flowgates

If a Reciprocal Entity believes that another Reciprocal Entity implementing the congestion management portion of this process has a significant impact on one of their Flowgates, but that Flowgate was not included in the Coordinated Flowgate list, the involved Reciprocal Entities will use the following process.

- If an operating emergency exists involving the candidate Flowgate, the Reciprocal Entities shall treat the facilities as a temporary Coordinated Flowgate prior to the study procedure below. If no operating emergency or imminent danger exists, the study procedure below shall be pursued prior to the candidate Flowgate being designated as a Coordinated Flowgate.

- The Reciprocal Entity conducts studies to determine the conditions under which the other Reciprocal Entity would have a significant impact on the Flowgate in question. The Reciprocal Entity conducting the study then submits these studies to the other Reciprocal Entity implementing this process. The Reciprocal Entity's studies should include each of the four studies described above; in addition to any other studies they believe illustrate the validity of their request. The other Reciprocal Entity will review the studies and determine if they appear to support the request of the Reciprocal Entity conducting the study. If they do, the Flowgate will be added to the list of Coordinated Flowgates.
- If, following evaluation of the supplied studies, any Reciprocal Entity still disputes another Reciprocal Entity's request, the Reciprocal Entity will submit a formal request to the NERC Operations Reliability Subcommittee (ORS) asking for further review of the situation. The ORS will review the studies of both the requesting Reciprocal Entity and the other Reciprocal Entity, and direct the participating Reciprocal Entities to take appropriate action.

3.2.3 Third Party Request Flowgate Additions

Each party shall provide in its stakeholder processes opportunities for third parties or other entities to propose additional Coordinated Flowgates and procedures for review of relevant non-confidential data in order to assess the merit of the proposal. The current procedure for the review and maintenance of Coordinated Flowgates is set forth in Appendix C.

3.2.4 Frequency of Coordinated Flowgate Determination

The determination of Coordinated Flowgates will be performed at the initial implementation of the CMP and then on a periodic basis, as described in Appendix C.

3.2.5 Dynamic Creation of Coordinated Flowgates

For temporary Flowgates developed "on the fly," the IDC will utilize the current IDC methodology for determining NNL contribution until the Market-Based Operating Entity has begun reporting data for the new Flowgate. Interchange transactions into, out of, or across the Market-Based Operating Entity will continue to be E-tagged and available for curtailment in TLR 3, 4, or 5. Market-Based Operating Entities will study the Flowgate in a timely manner and begin reporting Flowgate data within no more than two business days (where the Flowgate has already been designated as an AFC Flowgate). This will ensure that the Market-Based Operating Entity has the time necessary to properly study the Flowgate using the four studies detailed earlier in this document and determine the Flowgate's relationship with the Market-Based Operating Entity's dispatch. For internal Flowgates, the Market-Based Operating Entity will redispatch during a TLR 3 to manage the constraint as necessary until it begins reporting the Firm and Non-Firm Market Flows; during a TLR 5, the IDC will request NNL relief in the same manner as today. Alternatively, for internal and external Flowgates, an Operating Entity may utilize an appropriate substitute Coordinated Flowgate that has similar Market Flows and tag impacts as the temporary Flowgate. In this case, an Operating Entity would have to realize relief through redispatch and TLR 3. An example of an appropriate substitute would be a Flowgate

with a monitored element directly in series with a temporary Flowgate's monitored element and with the same contingent element. If the Flowgate meets the necessary criteria, the Market-Based Operating Entity will begin to provide the necessary values to the IDC in the same manner as Market Flow values are provided to the IDC for all other Coordinated Flowgates. The necessary criteria for adding a Flowgate are defined in Appendix C. If in the event of a system emergency (TLR 3b or higher) and the situation requires a response faster than the process may provide, the Market-Based Operating Entities will coordinate respective actions to provide immediate relief until final review.

Section 4 – Market-Based Operating Entity Flow Calculations: Market Flow, Firm Market Flow, and Non-Firm Market Flow

Market Flows on a Coordinated Flowgate can be quantified and considered in each direction. Market Flow is then further designated into two components: Firm Market Flow, which is energy flow related to contributions from the Network and Native Load serving aspects of the dispatch, and Non-Firm Market Flow, which is energy flow related to the Market-Based Operating Entity's market operations.

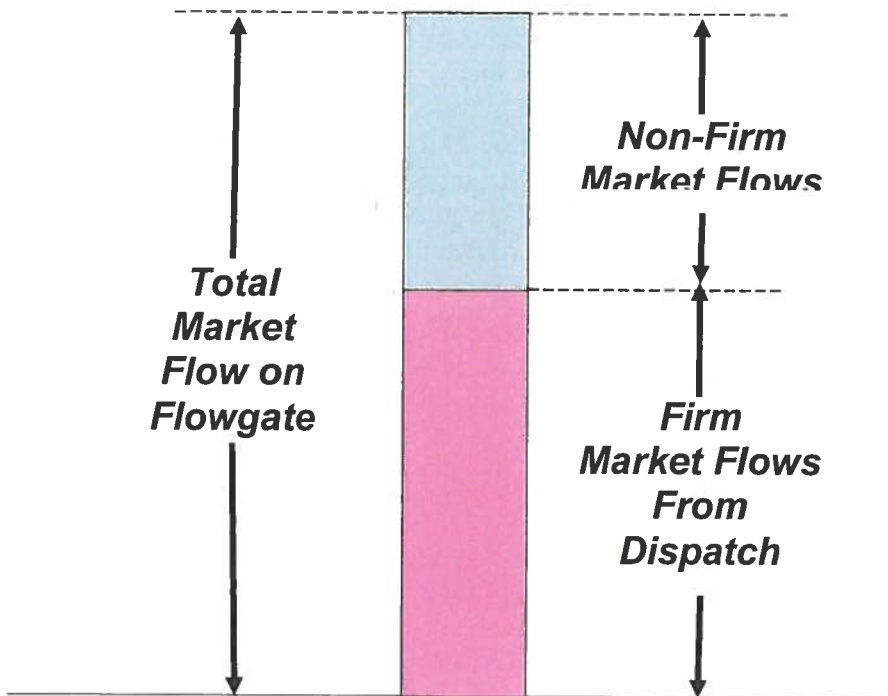

Note: Market flows equal generation to load flows in market areas.

Each Market-Based Operating Entity will calculate their actual real-time and projected directional Market Flows, as well as their directional Firm and Non-Firm Market Flows, on each Coordinated Flowgate. The following sections outline how these flows will be computed.

4.1 Market Flow Determination

The determination of Market Flows builds on the “Per Generator” methodologies that were developed by the NERC Parallel Flow Task Force. The “Per Generator Method Without Counter Flow” was presented to and approved by both the NERC Security Coordinator Subcommittee (SCS) and the Market Interface Committee (MIC).¹ This methodology is presently used in the IDC to determine NNL contributions.

Similar to the Per Generator Method, the Market Flow calculation method is based on Generator Shift Factors (GSFs) of a market area’s assigned generation and the Load Shift Factors (LSFs) of its load on a specific Flowgate, relative to a system swing bus. The GSFs are calculated from a single bus location in the base case (e.g. the terminal bus of each generator) while the LSFs are defined as a general scaling of the market area’s load. The Generator to Load Distribution Factor (GLDF) is determined through superposition by subtracting the LSF from the GSF.

The determination of the Market Flow contribution of a unit to a specific Flowgate is the product of the generator’s GLDF multiplied by the actual output (in megawatts) of that generator. The total Market Flow on a specific Flowgate is calculated in each direction; forward Market Flows is the sum of the positive Market Flow contributions of each generator within the market area, while reverse Market Flow is the sum of the negative Market Flow contributions of each generator within the market area.

For purposes of the Market Flow determination, the market area may be the entire RTO footprint, as in the following illustration, or it may be a subset of the RTO region, such as a pre-integration NERC-recognized Control Area, as necessary to ensure accurate determinations and consistency with pre-integration flow determinations. In the latter case, the total market flow of an RTO shall be the sum of the flows from and between such market areas.

¹ “Parallel Flow Calculation Procedure Reference Document,” NERC Operating Manual. 11 Feb, 2003. <<http://www.nerc.com/~oc/opermanl.html>>

Calculating the Market Flow Illustration

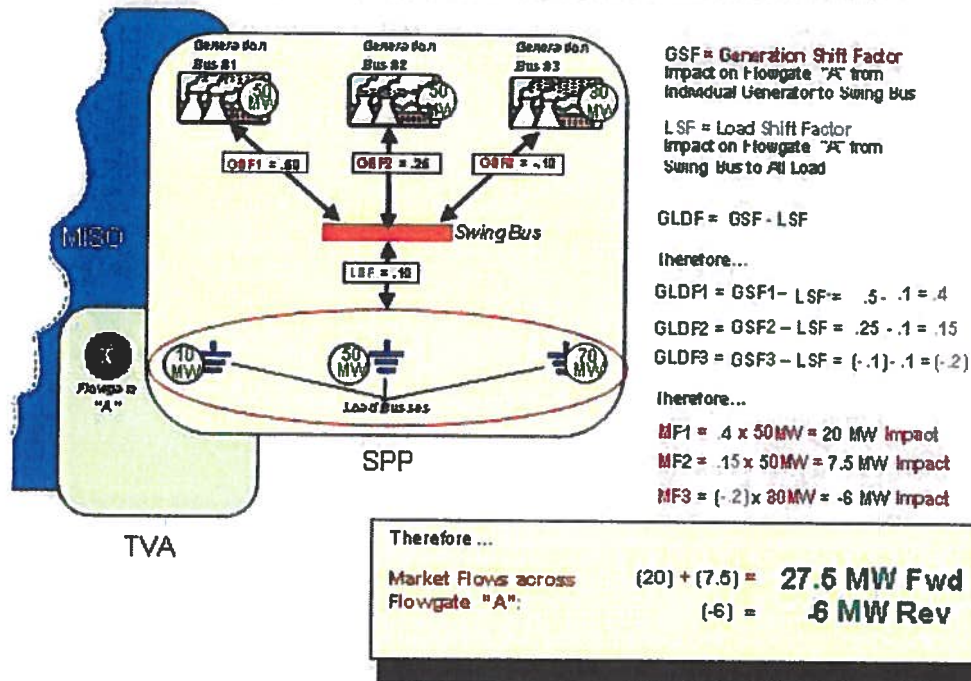

The Market Flow calculation differs from the Per Generator Method in the following ways:

- The contribution from all market area generators will be taken into account.
- In the Per Generator Method, only generators having a GLDF greater than 5% are included in the calculation. Additionally, generators are included only when the sum of the maximum generating capacity at a bus is greater than 20 MW. The Market Flow calculations will use all flows, in both directions, down to a 5% threshold for the IDC to assign TLR curtailments and down to a 0% threshold for information purposes. Forward flows and reverse flows are determined as discrete values.
- The contribution of all market area generators is based on the present output level of each individual unit.
- The contribution of the market area load is based on the present demand at each individual bus.

By expanding on the Per Generator Method, the Market Flow calculation evolves into a methodology very similar to the "Per Generator Method," while providing granularity on the order of the most granular method developed by the IDC Granularity Task Force.

Directional flows are required for this process to ensure a Market-Based Operating Entity can effectively select the most effective generation pattern to control the flows on both internal and external constraints, but are considered as distinct directional flows to ensure

comparability with existing NERC and/or NAESB TLR processes. Under this process, the use of real-time values in concert with the Market Flow calculation effectively implements one of the more accurate and detailed methods of the six IDC Granularity Options considered by the NERC IDC Granularity Task Force.

Each Market-Based Operating Entity shall choose one of the three methodologies set forth in Section 4.1.1 (*Methodologies to Account for Tagged Transactions*) below to account for import and export tagged transactions and shall apply it consistently for each of the following calculations:

1. the Market Flow calculation;
2. the Firm Flow Limit calculation;
3. the Firm Flow Entitlement calculation; and
4. the tagged transaction impact calculation which occurs in the IDC.

Market Flows are defined as the calculated energy flows on a specified Flowgate as a result of dispatch of generating resources serving market load within a Market-Based Operating Entity's market. Specifically, Market Flows represent the impacts of internal generation serving internal load and tagged grandfathered transactions within the market area; however, Market Flows do not include the impacts from import tagged transaction(s) into and export tagged transaction(s) out of the market area since the impacts of the interchange transactions are accounted for by the IDC. A Market-Based Operating Entity shall utilize the IDC to calculate the impacts of import and export transactions that are not captured in the Market Flow calculation.

Units assigned to serve a market area's load do not need to reside within the market area's footprint to be considered in the Market Flow calculation. Units outside of the market area that are pseudo-tied into the market to serve the market area's load will be included in the Market Flow calculation. However, units outside of the market area will not be considered when those units will have tags associated with their transfers (i.e., where pseudo-tie does not exist).

Additionally, there may be situations where the participation of a generator in the market that is not modeled as a pseudo-tie may be less than 100% (e.g., a unit jointly owned in which not all of the owners are participating in the market). This situation occurs when the generator output controlled by the non-participating parties is represented as interchange with a corresponding tag(s) and not as a pseudo-tie generator internal to each party's Control Area. Except for the generator output represented by qualifying interchange transactions from jointly owned units described in the following paragraph, such situations will be addressed by including the generator output in that Market-Based Operating Entity's Market Flow calculation with the amount of generator output not participating in the market being scaled down within the Market-Based Operating Entity's region or regions in accordance with one of the following three methodologies described and defined below in Section 4.1.1.: the Marginal Zone Method, POR-POD Method, or Slice-of-System Method.

When a jointly owned unit, which is also listed as a Designated Network Resource for the Historic Firm Flow calculation, participates in more than one market (each of which report Market Flow to the IDC), and the generator output from that unit between the two markets is represented as interchange with a corresponding tag(s) and not as a pseudo-tie generator internal to each market's Control Area, its modeling in the Market Flow calculation will be aligned with that in the Historic Firm Flow calculation. The amount of generator output from that unit scheduled between the two markets will be treated as a unit-specific export tagged transaction in the Market Flow calculation of the Market-Based Operating Entity where the generator is located and will be treated as a load-specific import tagged transaction in the Market Flow calculation of the other Market-Based Operating Entity.

- For exports out of one market area associated with the jointly owned unit(s), the generator output of jointly owned unit will be scaled down by an amount which is the lesser of the corresponding export tagged transaction(s) and unit ownership of an owner participating in other market area.
- For imports into the other market area associated with the jointly owned external unit(s), the Control Zone load or bus load(s) will be scaled down by an amount which is the lesser of the corresponding import tagged transaction(s) and unit ownership of an owner participating in the market area.

Import tagged transactions, export tagged transactions, and grandfathered tagged transactions within the market area, must be properly accounted for in the determination of Market Flows.

Below is a summary of the calculations discussed above.

For a specified Flowgate, the Market Flow impact of a market area is given as:

Total Directional "Market Flows" = \sum (Directional "Market Flow" contribution of each unit in the Market-Based Operating Entity's area), grouped by impact direction

where,

"Market Flow" contribution of each unit in the Market-Based Operating Entity's area =

(GLDF_{Adj}) (Adjusted Real-Time generator output)

and,

GLDF_{Adj} is the Generator to Load Distribution Factor

Where the generator shift factor (GSF_{Adj}) uses Adjusted Real-Time generator output and the load shift factor (LSF_{Adj}) uses Adjusted Real-Time bus loads.

GLDF_{Adj} = GSF_{Adj} - LSF_{Adj}

Adjusted Real-Time generator output is the output of an individual generator as reported by the state estimator solution that has been adjusted for exports associated with joint ownership, if any, and then further adjusted for the remaining exports utilizing the chosen methodology in Section 4.1.1.

Adjusted Real-Time bus load is the sum of all bus loads in the market as reported by the state estimator solution that have been adjusted for imports associated with joint ownership, if any, and then further adjusted for the remaining imports utilizing the chosen methodology in Section 4.1.1..

The real-time and one-hour ahead projected “Market Flows” will be calculated on-line utilizing the Market-Based Operating Entity’s state estimator model and solution. This is the same solution presently used to determine real-time market prices as well as providing on-line reliability assessment and the periodicity of the Market Flow calculation will be on the same order. Inputs to the state estimator solution include the topology of the transmission system and actual analog values (e.g., line flows, transformer flows, etc...). This information is provided to the state estimator automatically via SCADA systems such as NERC’s ISN link.

Using an on-line state estimator model to calculate “Market Flows” provides a more accurate assessment than using an off-line representation for a number of reasons. The calculation incorporates a significant amount of real-time data, including:

- **Actual real-time and projected generator output.** Off-line models often assume an output level based on a nominal value (such as unit maximum capability), but there is no guarantee that the unit will be operating at that assumed level, or even on-line. Off-line models may not reflect the impact of pumped-storage units when in pumping mode; these units may be represented as a generator even when pumping. Additionally off-line models may not reflect the impact of units such as wind generators. A real-time calculation explicitly represents the actual operating modes of these units.
- **Actual real-time bus loads.** Off-line assessments may not be able to accurately account for changes in load diversity. Off-line models are often based on seasonal winter and summer peak load base cases. While representative of these peak periods, these cases may not reflect the load diversity that exists during off-peak and shoulder hours as well as off-peak and shoulder months. A real-time calculation explicitly accounts for load diversity. Off-line assessments may also reflect load reduction programs that are only in effect during peak periods.
- **Actual real-time breaker status.** Off-line assessments are often bus models, where individual circuit breakers are not represented. On-line models are typically node models where switching devices are explicitly represented. This allows for the real-time calculation to automatically account for split bus conditions and unusual topology conditions due to circuit breaker outages.

Additionally, the calculation rate of the on-line assessment is much quicker and accurate than an off-line assessment, as the on-line assessment immediately incorporates changes in system topology and generators. Facility outages are automatically incorporated into the real-time assessment.

In order to provide reliable and consistent flow calculations, entities utilizing this process as the basis for coordination must ensure that the modeling data and assumptions used in the calculation process are consistent. Reciprocal Entities will coordinate models to ensure similar computations and analysis. Reciprocal Entities will each utilize real-time ICCP and ISN data for observable areas in each of their respective state estimator models and will utilize NERC data for areas outside the observable areas to ensure their models stay synchronized with each other and the NERC IDC.

4.1.1 Methodologies to Account for Tagged Transactions

A Market-Based Operating Facility shall choose one of the following methodologies to account for export and import tagged transactions in the Market Flow reported to the IDC and utilized for market-to-market, and shall also use the same methodology to account for export and import tagged transactions, in the Firm Flow Limit and Firm Flow Entitlement calculations, as well as calculated tag impacts by the IDC:

1. Point-of-receipt (POR) / point-of-delivery (POD) Method (POR-POD Method) - Export tagged transactions, excluding tagged transactions associated with jointly owned units participating in more than one market (each of which report Market Flow to the IDC), shall be accounted for based on the POR of the transmission service reservation, as the transmission service was originally sold, that is listed on the export tagged transaction by proportionally offsetting the MW output of all units (i) in the Market-Based Operating Entity's Control Area, (ii) pre-integration NERC-recognized Control Area(s), or (iii) sub-regions within its Control Area. Import tagged transactions, excluding tagged transactions associated with jointly owned units participating in more than one market (each of which report Market Flow to the IDC), shall be accounted for based on the POD of the transmission service reservation, as the transmission service was originally sold, that is listed on the export tagged transaction by proportionally offsetting the MW load of all load buses (i) in the Market Based Operating Entity's Control Area, (ii) pre-integration NERC-recognized Control Area(s), or (iii) sub-regions within the Control area; or
2. Marginal Zone Method – Export tagged transactions, excluding tagged transactions associated with jointly owned units participating in more than one market (each of which report Market Flow to the IDC), shall be accounted for by adjusting the MW output of the units in the Market-Based Operating Entity's Control Area, regions, or subregions within its Control Area by the total MW amount of all the Market-Based Operating Entity's export tagged transactions excluding tagged transactions associated with jointly owned units participating in more than one market (each of which report Market Flow to the IDC) using: (1) marginal zone participation factors, as defined and calculated in Appendix B (*Determination of Marginal Zone Participation Factors*); and (2) the anticipated availability of a generator to participate in the interchange of the marginal zone. Import tagged transactions, excluding tagged transactions associated with jointly owned units participating in more than one market (each of which report Market Flow to the IDC), shall be accounted for by adjusting the MW load of the load buses in the in the Market-Based Operating Entity's Control Area, regions or subregions within the Control Area, by the total MW amount of all the Market-Based Operating Entity's import tagged transactions excluding tagged transactions associated with jointly owned units participating in more than one market (each of which report Market Flow to the IDC) using marginal zone participation factors, as defined and calculated in Appendix B (*Determination of Marginal Zone Participation Factors*); or
3. Slice of System Method – Export tagged transactions, excluding tagged transactions associated with jointly owned units participating in more than one market (each of which report Market Flow to the IDC), shall be accounted for by proportionately adjusting the MW output of each of the units in the Market-Based Operating Entity's Control Area by

the total MW amount of all the Market-Based Operating Entity's export tagged transactions excluding tagged transactions associated with jointly owned units participating in more than one market (each of which report Market Flow to the IDC). Import tagged transactions, excluding tagged transactions associated with jointly owned units participating in more than one market (each of which report Market Flow to the IDC), shall be accounted by proportionately adjusting the MW load of each of the load buses in the Market-Based Operating Entity's Control Area by the total MW amount of all the Market-Based Operating Entity's import tagged transactions excluding tagged transactions associated with jointly owned units participating in more than one market (each of which report Market Flow to the IDC).

Each Market-Based Operating Entity shall post and maintain a document on its public website that describes calculations and assumptions used in those calculations regarding the chosen methodology and its application to the treatment of import and export transactions to the calculation of Market Flows, Firm Flow Limits, and Firm Flow Entitlements, and tag impacts calculated by the IDC.

4.2 Firm Flow Determination

Firm Market Flows represent the directional sum of flows created by Designated Network Resources serving designated network loads within a particular market area. They are based primarily on the configuration of the system and its associated flow characteristics; utilizing generation and load values as its primary inputs. Therefore, these Firm Market Flows can be determined based on expected usage and the Allocation of Flowgate capacity.

An entity can determine Firm Market Flows on a particular Flowgate using the same process as utilized by the IDC. This process is summarized below:

1. Utilize a reference base case to determine the Generation Shift Factors for all generators in the current Control Areas' respective footprints to a specific swing bus with respect to a specific Flowgate.
2. Utilize the same base case to determine the Load Shift Factors for the Control Area's load to a specific swing bus with respect to that Flowgate.
3. Utilize superposition to calculate the Generation to Load Distribution Factors (GLDF) for the generators with respect to that Flowgate.
4. Multiply the expected output used to serve native load from each generator by the appropriate GLDF to determine that generator's flow on the Flowgate.
5. Sum these individual contributions by direction to create the directional Firm Market Flow impact on the Flowgate.

4.3 Determining the Firm Flow Limit

Given the Firm Market Flow determinations described in the previous section, Market-Based Operating Entities can assume them to be their Firm Flow Limits. These limits define the maximum value of the Market Flows that can be considered as firm in each direction on a particular Flowgate. Prior to real time, a calculation will be done based on updated hourly forecasted loads and topology. The results should be an hourly forecast of directional Firm Market Flows. This is a significant improvement over current IDC processes, which uses a peak load value instead of an hourly load more closely aligned with forecasted data.

4.4 Firm Market Flow Calculation Rules

The Firm Flow Limits for both 0% Market Flows and 5% Market Flows will be calculated based on certain criteria and rules. The calculation will include the effects of firm network service in both forward and reverse directions. The process will be similar to that of the IDC but will include one set of impacts down to 0% and another set down to 5%. The down to 0% impacts will be used to determine Firm Flow Limits on 0% Market Flows. The down to 5% impacts will be used to determine Firm Flow Limits on 5% Market Flows. The following points form the basis for the calculation.

1. The generation-to-load calculation will be made on a Control Area basis. The impact of generation-to-load will be determined for Coordinated Flowgates.
2. The Flowgate impact will be determined based on individual generators serving aggregated CA load. Only generators that are Designated Network Resources for the CA load will be included in the calculation.
3. Forward Firm Flow Limits for 0% Market Flows will consider impacts in the additive direction down to 0%, and reverse Firm Flow Limits for 0% Market Flows will consider impacts in the counter flow direction down to 0%. Forward Firm Flow Limits for 5% Market Flows will be determined by subtracting impacts between 0% and 5% in the additive direction from the Forward Firm Flow Limit for 0% Market Flows. Reverse Firm Flow Limits for 5% Market Flows will be determined by subtracting the impacts between 0% and 5% in the counter-flow direction from the reverse Firm Flow Limit for 0% Market Flows. Market Flow impacts and allocations using a 5% threshold are reported to the IDC to assign TLR curtailments. Market Flow impacts and allocations using a 0% threshold are reported to the IDC for information purposes.
4. Designated Network Resources located outside the CA will not be included in the generation-to-load calculation if OASIS reservations exist for these generators.
5. If a generator or a portion of a generator is used to make off-system sales that have an OASIS reservation, that generator or portion of a generator should be excluded from the generation-to-load calculation.
6. Generators that will be off-line during the calculated period will not be included in the generation-to-load calculation for that period.
7. CA net interchange will be computed by summing all Firm Transmission Service reservations and all Designated Network Resources that are in effect throughout the calculation period. Designated Network Resources are included in CA net interchange to the extent they are located outside the CA and have an OASIS reservation. The net interchange will either be positive (exports exceed imports) or negative (imports exceed exports).
8. If the net interchange is negative, the period load is reduced by the net interchange.
9. If the net interchange is positive, the period load is not adjusted for net interchange.

10. The generation-to-load calculation will be made using generation-to-load distribution factors that represent the topology of the system for the period under consideration.
11. P_{MAX} of the generators should be net generation (excluding the plant auxiliaries) and the CA load should not include plant auxiliaries.
12. The portion of jointly owned units that are treated as schedules will not be included in the generation-to-load calculation if an OASIS reservation exists.

Section 5 – Market-Based Operating Entity Congestion Management

Once there has been an establishment of the Firm Flow Limit that is possible given Firm Market Flow calculation, that data will be used in the operating environment in a manner that relates to real time energy flows.

5.1 Calculating Market Flows

On a periodic basis, the Market-Based Operating Entity will calculate directional Market Flows for all Coordinated Flowgates. These flows will represent the actual flows in each direction at the time of the calculation, and be used in concert with the previously calculated Firm Flow Limits to determine the portion of those flows that should be considered firm and non-firm.

5.2 Quantify and Provide Data for Market Flow

Every fifteen minutes, the Market-Based Operating Entity will be responsible for providing to Reliability Coordinators the following information:

- Firm Market Flows for all Coordinated Flowgates in each direction
- Non-Firm Market Flows for all Coordinated Flowgates in each direction

The Firm Market Flow (Priority 7-FN) will be equivalent to the calculated Market Flow, up to the Firm Flow Limit. In real time, any Market Flow in excess of the Firm Flow Limit will be reported as Non-Firm Market Flow (Priority 6-NN) (note that under reciprocal operations, some of this Non-Firm Market Flow may be quantified as Priority 2-NH).

This information will be provided for both current hour and next hour, and is used in order to communicate to Reliability Coordinators the amount of flows to be considered firm on the various Coordinated Flowgates in each direction. When the Firm Flow Limit forecast is calculated to be greater than Market Flow for current hour or next hour, actual Firm Flow Limit (used in TLR5) will be set equal to Market Flow.

Additionally, as frequently as once an hour, but no less frequently than once every three months, the Market-Based Operating Entity will submit to the Reliability Coordinator sets of data describing the marginal units and associated participation factors for generation within the market footprint. The level of detail of the data may vary, as different Operating Entities will have different unique situations to address. However, this data will at a minimum be supplied for imports to and exports from the market area, and will contain as much information as is determined to be necessary to ensure system reliability. This data will be used by the Reliability Coordinators to determine the impacts of schedule curtailment requests when they result in a shift in the dispatch within the market area.

5.3 Day-Ahead Operations Process

The Market-Based Operating Entities will use a day-ahead operations process to establish the Firm Flow Limit on Coordinated Flowgates. If the Market-Based Operating Entities utilize a day-ahead unit commitment, they will supplement the day-ahead unit commitment with a security constrained economic dispatch tool, which uses a network analysis model that mirrors the real-time model found within their state estimators. As such, the day-ahead unit commitment and its associated Security Constrained Economic Dispatch respects facility limits and forecasted system constraints. Facility limits of Coordinated Flowgates under the functional control of Market-Based Operating Entities and the allocations of all Reciprocal Coordinated Flowgates will be honored.

For Coordinated Flowgates, a Market-Based Operating Entity can only use one of the following two methods to establish Firm Flow Limit. A Market-Based Operating Entity must use either the day-ahead unit commitment and its associated Security Constrained Economic Dispatch, or a Market-Based Operating Entity's GTL and unused Firm Transmission Service impacts, up to the Flowgate Limit, on the Coordinated Flowgate. At any given time, an entity must use only one method for all Coordinated Flowgates and must give ninety days notice to all other Reciprocal Entities, if it decides to switch from one method to the other method. On a case by case basis, with agreement by all Reciprocal Entities the ninety-day notice period may be waived.

5.4 Real-time Operations Process – Operating Entity Capabilities

Operating Entities' real-time EMS's have very detailed state estimator and security analysis packages that are able to monitor both thermal and voltage contingencies every few minutes. State estimation models will be at least as detailed as the IDC model for all the Coordinated and Reciprocal Coordinated Flowgates. Additionally, Reciprocal Entities will be continually working to ensure the models used in their calculation of Market Flow are kept up to date.

The Market-Based Operating Entities' state estimators and Unit Dispatch Systems (UDS) will utilize these real-time internal flows and generator outputs to calculate both the actual and projected hour ahead flows (i.e., total Market Flows, Non-Firm Market Flows, and Firm Market Flows) on the Coordinated Flowgates. Using real-time modeling, the Market-Based Operating Entity's internal systems will be able to more reliably determine the impact on Flowgates created by dispatch than the NERC IDC. The reason for this difference in accuracy is that the IDC uses static SDX data that is not updated in real-time. In contrast to the SDX data, the Market-Based Operating Entity's calculations of system flows will utilize each unit's actual output, updated at least every 15 minutes on an established schedule.

5.5 Market-Based Operating Entity Real-time Actions

Market-Based Operating Entities will have the list of Coordinated Flowgates modeled as monitored facilities in its EMS. The Firm Flow Limits a Market-Based Operating Entity will use for these Flowgates will be the Firm Flow Limits determined by the Firm Market Flow calculations.

The Market-Based Operating Entity will upload the real-time and one-hour ahead projected Firm Market Flows (7-FN) and Non-Firm Market Flows (6-NN) on these Flowgates to the IDC every 15 minutes, as requested by the NERC IDCWG and OATI (note that under reciprocal operations, some of this 6-NN may be quantified as Priority 2-NH). Market Flows will be calculated, down to five percent and down to zero percent, and uploaded to the IDC. When the real-time actual flow exceeds the Flowgate limit and the Reliability Coordinator, who has responsibility for that Flowgate, has declared a TLR 3a or higher, the IDC will determine tag curtailments, Market Flow relief obligations and NNL relief obligations using a 5% tag impact, Market Flow impact and NNL impact threshold. The Market-Based Operating Entity will respond to the relief obligation by redispatching their system in a manner that is consistent with how non-market entities respond to their NNL relief obligations. Note the Market-Based Operating Entity and the non-market-entities may provide relief through either: (1) a reduction of flows on the Flowgate in the direction required, or (2) an increase of reverse flows on the Flowgate.

Market-Based Operating Entities will implement this redispatch by binding the Flowgate as a constraint in their Unit Dispatch System (UDS). UDS calculates the most economic solution while simultaneously ensuring that each of the bound constraints is resolved reliably. Additionally, the Market-Based Operating Entity will make any point-to-point transaction curtailments as specified by the NERC IDC.

The Reliability Coordinator calling the TLR will be able to see the relief provided on the Flowgate as the Market-Based Operating Entity continues to upload its contributions to the real-time flows on this Flowgate.

Section 6 - Reciprocal Operations

Reciprocal Coordination Agreements can be executed on a market-to-market basis, a market-to-non-market basis, and a non-market-to-non-market basis. While the congestion management portions of this document are intended to apply specifically to Market-Based Operating Entities, the agreement to allocate Flowgate capability is not dependent on an entity operating a centralized energy market. Rather, it simply requires that a set of Flowgates be defined upon which coordination shall occur and an agreement to perform such coordination.

6.1 Reciprocal Coordinated Flowgates

In order to coordinate congestion management on a proactive basis, Operating Entities may agree to respect each other's Flowgate limitations during the determination of AFC/ATC and the calculation of firmness during real-time operations. Entities agreeing to coordinate this future-looking management of Flowgate capacity are Reciprocal Entities. The Flowgates used in that process are Reciprocal Coordinated Flowgates.

6.2 The Relationship Between Coordinated Flowgates and Reciprocal Coordinated Flowgates

Coordinated Flowgates are associated with a specific entity's operational sphere of influence. Reciprocal Coordinated Flowgates are associated with the implementation of a Reciprocal Coordination Agreement between two Reciprocal Entities. By virtue of having executed such an agreement, a Flowgate Allocation can occur between these two Reciprocal Entities as well as all other Reciprocal Entities that have executed Reciprocal Coordination Agreements with at least one of these two Reciprocal Entities. When considering an implementation between two Reciprocal Entities, it is generally expected that each of the Reciprocal Coordinated Flowgates will meet the following three criteria:

- It will meet the criteria for Coordinated Flowgate status for both the Reciprocal Entities,
- It will be under the functional control of one of the two Reciprocal Entities and
- Both Reciprocal Entities have executed Reciprocal Coordination Agreements either with each other or with a third party Reciprocal Entity.

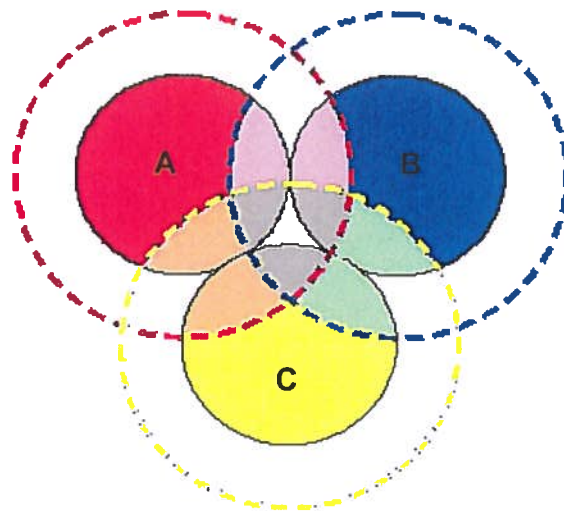

As shown in the illustration above, Operating Entity A, Operating Entity B and Operating Entity C each have their own set of Coordinated Flowgates (represented by the blue, yellow and red dotted-line circles). Where those sets of Coordinated Flowgates overlap AND they are in either Operating Entity A's, Operating Entity B's or Operating Entity C's service territory (the gray area), they will be considered Reciprocal Coordinated Flowgates between all three entities. Where those sets of Coordinated Flowgates overlap AND they are in either Operating Entity A's or Operating Entity B's service territory (the purple area), they will be considered Reciprocal Coordinated Flowgates between Operating Entity B and Operating Entity A only. Where those sets of Coordinated Flowgates overlap AND they are in either Operating Entity B's or Operating Entity C's service territory (the green area), they will be considered Reciprocal Coordinated Flowgates between Operating Entity B and Operating Entity C only. Where those sets of Coordinated Flowgates overlap AND they are in either Operating Entity A's or Operating Entity

C's service territory (the orange area), they will be considered Reciprocal Coordinated Flowgates between Operating Entity A and Operating Entity C only.

To the extent that entities other than Market-Based Operating Entities may enter into a Reciprocal Coordination Agreements, they may offer to coordinate on Flowgates that are Coordinated Flowgates (i.e., have passed one of the four tests defined within this document or otherwise been deemed to be a Coordinated Flowgate).

6.3 Coordination Process for Reciprocal Flowgates

The following process and timing will be used for coordinating the ATC/AFC calculations and Firm Flow Limit calculations/Allocations between Reciprocal Entities. Further, the process quantifies and limits Priority 6 – NN service on the Reciprocal Coordinated Flowgates, as well as determines priority 2-NH service. All Reciprocal Entities' Firm Flow Limits will be calculated on the same basis.

6.4 Calculating Historic Firm Flows

As a starting point for identifying Allocations, an understanding must be developed of what Firm Flows would be in the historic Control Area structure. In other words, there must be a quantification of the Firm Flows that would have occurred if all Control Areas maintained their current configuration and continued to: (1) serve their native load with their Designated Network Resources, and (2) import and export energy at historical levels (based upon Firm Transmission Service reservations as of the Freeze Date, which is currently set as April 1, 2004). This flow is referred to as Historic Firm Flow.

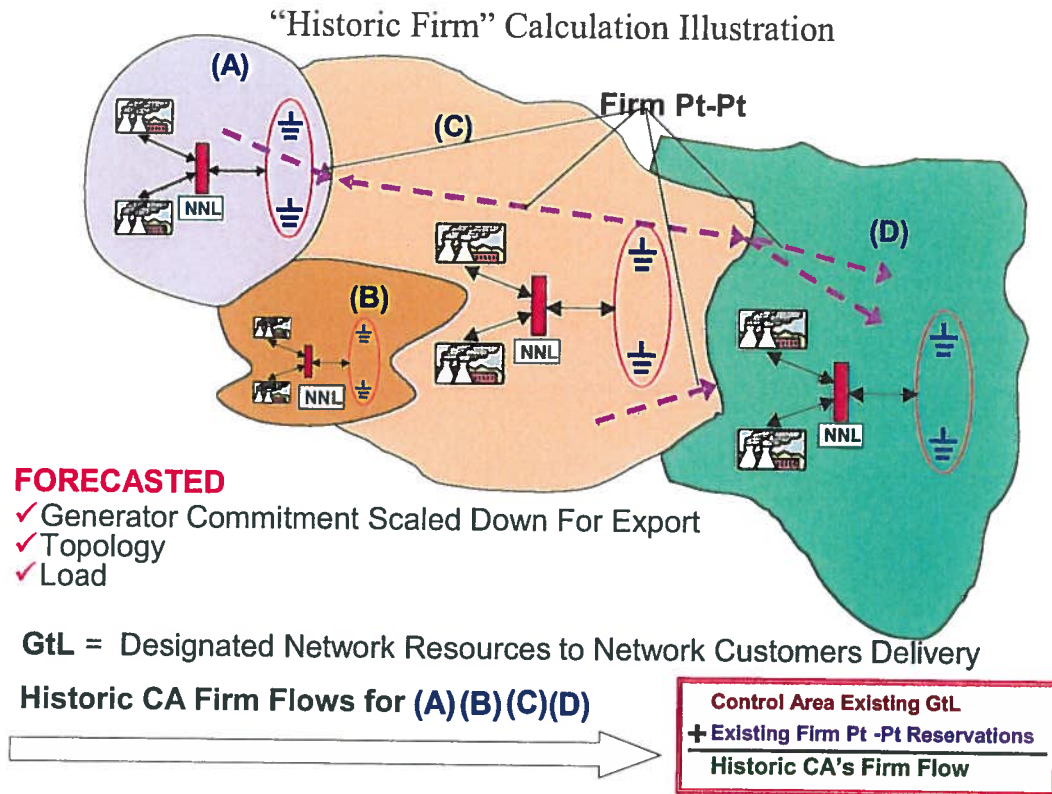

Reciprocal Entities will utilize the IDC Base Case model, or a mutually agreed upon alternative model as the reference base case for these calculations.

6.5 Recalculation of Initial Historic Firm Flow Values and Ratios

The Firm Transmission Service and Designated Network Resource to customer load defined by the Historic Firm Flow calculation will be updated in the recalculation of Historic Firm Flow utilizing any new Designated Network Resources, updated customer loads, and new transmission facilities. The original historic Control Areas will be retained for the recalculation of Historic Firm Flow. New Designated Network Resources will be included in the recalculation to the extent these new Designated Network Resources have been arranged for the exclusive use of load within the historic Control Areas and to the extent the total impact of all Designated Network Resources does not exceed the historic Control Area impact of Designated Network Resources as of a “Freeze Date” (defined as April 1, 2004). Any changes to Designated Network Resources and/or the transmission system that increase transmission capability will be assessed in accordance with the Reciprocal Entities AFC Coordination procedures prior to the increasing of Historic Firm Flow related to those systems.

The initial Historic Firm Flow calculated values and resulting Allocation ratios will be recalculated as seasonal cases are produced. This recalculation will utilize the same Firm Transmission Service reservations that were used in the initial Historic Firm Flow calculation. The same Firm Transmission Service reservations are used so that Market-Based Operating Entities that have their Firm Transmission Service internalized, grant fewer internal Firm Transmission Service reservations, or have their original Firm Transmission Service reservations end, because of their market operations, will retain at least the same level of Firm Transmission Service as in the initial Historic Firm Flow calculation. Therefore, the Firm Transmission Service component of the Historic Firm Flow will be frozen on the “Freeze Date” at the initially calculated level for both market and non-market entities.

Any new Control Areas that are added to the Firm Flow calculation process for any Reciprocal Entity, or another Operating Entity, will use Firm Transmission Service reservations from the initial Historic Firm Flow calculation date to establish their Firm Transmission Service component of the Historic Firm Flow.

As the recalculation for Historic Firm Flow is made for each time period, the higher of allocation value will be retained between the initial Historic Firm Flow calculation and the recalculation (See “Forward Coordination Process” Section 6.6, step 8.f). To the extent an Operating Entity has made commitments based on the higher of Allocation value, a recalculation does not reduce previously calculated Allocations.

When a Flowgate experiences a transitory limit reduction or de-rating, there will be no change made to the historic allocations. In effect, the Operating Entity responsible for the Flowgate is expected to absorb the impact of the de-rating by not reducing the historic allocation of the other Operating Entities. This practice is consistent with the use of the higher-of logic in the historic allocation process. Where a change in system conditions, such as a significant transmission outage, affects flows on a longer term basis the Reciprocal Entities will discuss whether historic allocations, including an over-ride of the higher-of logic, should be rerun to recognize the effects of the change in system conditions in the historic allocations. The historic allocations shall be rerun only if the affected Reciprocal Entities mutually agree.

6.6 Forward Coordination Processes

1. For each Reciprocal Coordinated Flowgate, a managing entity and an owning entity will be defined. The manager will be responsible for all calculations regarding that Flowgate; the owner will define the set of Firm Transmission Service reservations to be utilized when determining Firm Transmission Service impacts on that Flowgate.
2. Managing entities will calculate both Historic Firm Gen-to-Load Flow impacts and historic Firm Transmission Service impacts for all entities. These impacts will be used to define the Historic Ratio and the Allocation of transmission capability.
3. The managing entity will utilize the current NERC IDC Base Case (or other mutually agreeable base case) to determine impacts. The case should be updated with the most current set of outage data for the time period being calculated.
4. Managing entities will calculate Allocations on the following schedule:

Allocation Run Type	Allocation Process Start	Range Allocated	Allocation Process Complete
April Seasonal Firm	Every April 1 at 8:00 EST	Twelve monthly values from October 1 of the current year through September 30 of the next year	April 1 at 12:00 EST
October Seasonal Firm	Every October 1 at 8:00 EST	Twelve monthly values from April 1 of next year through March 31 of the following year	October 1 at 12:00 EST
Monthly Firm	Every month on the second day of the month at 8:00 EST	Six monthly values for the next six successive months	2 nd of the month at 12:00 EST
Weekly Firm	Every Monday at 8:00 EST	Seven daily values for the next Monday through Sunday	Monday at 12:00 EST
Two-Day Ahead Firm	Every Day at 17:00 EST	One daily value for the day after tomorrow	Current Day at 18:00 EST
Day Ahead Non-Firm	Every Day at 8:00 EST	Twenty-four hourly values for the next 24-hour period (Next Day HE1-HE24 EST)	Current Day at 9:00 EST

5. Historic Ratios are defined during the seasonal runs the first time an impact is calculated. For example, the 2004 April seasonal firm run would define the Historic Ratio for April 2005 – September 2005 (October through March would have been calculated during the 2003 October seasonal firm run). The Historic Ratio is based on the total impacts of the Reciprocal Entity on the Flowgate (Historic Firm Gen-to-Load Flows and historic Firm Transmission Service flows, down to 0%) relative to the total impacts of all other Reciprocal Entities' impacts on the Flowgate. For example, if Reciprocal Entity A had a 30 MW impact on the Flowgate and Reciprocal Entity B had a 70 MW impact on the Flowgate, the Historic Ratios would be 30% and 70%, respectively.

6. The same rules defined in the “Market-Based Operating Entity Congestion Management” Section 5 of this document for use in determining Firm Transmission Service impacts (NNL) shall apply when performing Allocations.
7. Additional rules to be used when considering Firm Transmission Service impacts are defined later within this section.
8. For each firm Allocation run described above, the managing entity will take the following steps to determine Allocations down to 0% for each of the Flowgates, in both the forward and reverse direction, they are assigned to manage:
 - a. Retrieve the Flowgate limit
 - b. Subtract the current Transmission Reliability Margin (TRM) value (may be zero)
 - c. Subtract the sum of all historically determined Firm Flow impacts for all entities based on impacts greater than or equal to 5%
 - d. Accommodation of Capacity Benefit Margin (CBM)
 - If no capacity remains after step (c), entities’ firm Allocation is limited to this amount (i.e., their Firm Flow impacts from impacts of 5% or greater), and the firm Allocation for the entity with functional control over the Flowgate is increased by the current CBM value (may be zero).
 - If capacity does remain after step (c), and the sum of all Reciprocal Entities’ impacts below 5% plus CBM is less than the remaining capacity from step (c), that capacity is allocated to the Reciprocal Entities pro-rata based on their Firm Flow impacts due to impacts less than 5% up to the total amount of their Firm Flow impacts due to impacts less than 5%.
 - If there is not sufficient capacity for all impacts below 5% plus CBM to be accommodated, the current CBM value is subtracted from the remaining capacity from step (c), and granted to the entity with functional control over the Flowgate. Any capacity remaining is allocated to the Reciprocal Entities pro-rata based on their Firm Flow impacts due to impacts less than 5%.
 - e. Any remaining capacity, after step (d) will be considered firm and allocated to Reciprocal Entities based on their Historic Ratio (as described in step 5). If the remaining capacity allocated to the entity with functional control over the Flowgate meets or exceeds the current CBM value, no further effort is needed. If the remaining capacity is less than the CBM, capacity will first be reduced by the CBM, and the entity with functional control over the Flowgate will be granted the capacity needed to support the CBM. In addition each Reciprocal Entity (including the entity with functional control over the Flowgate) will receive allocations determined as a pro-rata share of the remaining capacity (as described in Step 5).
 - f. Upon completion of the Allocation process, the managing entity will compare the current preliminary Allocation to the previous Allocations. For any given Flowgate, the larger of the Allocations will be considered the Allocation (i.e., an Allocation cannot decrease). Once all preliminary Allocations have been compared and the final Allocation determined, the managing entity will distribute the Allocations to the appropriate Reciprocal Entities. This Allocation will consist of the firm Gen-to-Load limit and a portion of capability that can be used either for Firm Transmission Service or additional firm Gen-to-Load service.

9. For the non-firm Allocation run described above, the managing entity will take the following steps to determine Allocations down to 0% for each of the Flowgates, in both the forward and reverse direction, they are assigned to manage. For each hour, the managing entity shall:
 - a. Retrieve the Flowgate limit
 - b. Subtract the current TRM value (may be zero)
 - c. Subtract the sum of all hourly historically determined Firm Flow impacts for all entities based on impacts greater than or equal to 5%
 - d. Subtract the sum of all hourly historically-determined Firm Flow impacts for all Reciprocal Entities based on impacts less than 5%.
 - e. Any remaining capacity will be allocated to Reciprocal Entities based on their Historic Ratio (as described in step 5).
 - f. The two-day ahead firm Allocation is subtracted from the total entity Allocation (from steps c, d, and e).
 - If the result is positive, this value will be equivalent to the Priority 6-NN Allocation/limit, and the Firm Flow Limit for 0% Market Flows will be the two-day ahead firm Allocation.
 - If the result is negative or zero, the Priority 6-NN Allocation will be calculated by subtracting the total entity Allocation (from steps c, d and e) from the two-day ahead firm Allocation. The Firm Flow Limit for 0% Market Flows will be the equivalent of the total entity allocation.
 - g. Upon completion of the Allocation process, the managing entity will distribute the Allocations to the appropriate Reciprocal Entities. These Allocations will be considered non-firm network service.

When a Market-Based Operating Entity is uploading Firm Market Flow contributions to the IDC, they will be responsible for ensuring that any firm Allocations are properly accounted for. If firm Allocations are used to provide additional firm network service, they should be included in the Firm Market Flow contribution. If they are used to provide additional Firm Transmission Service, they should not be included in the Firm Market Flow contribution.

The Market-Based Operating Entities will maintain in real-time their Firm Transmission Service and Network Non-Designated service impacts, including associated Market Flows, within their respective firm and Priority 6 total Allocations. The Firm Transmission Service impacts will be based on schedules. The Operating Entities participating in the Coordinated Process for Reciprocal Flowgates will respect their allocations when granting Firm Transmission Service.

Using the derived firm Allocation value, the Market-Based Operating Entity may choose to enter this value as a Flowgate limit for the respective Flowgate. If entered as a Flowgate limit, the Day-Ahead unit commitment will not permit flows to exceed this value as it selects units for this commitment. Market-Based Operating Entities will use the Flowgate limit to restrict unit outage scheduling for a Coordinated Flowgate when maintenance outage coordination indicates possible congestion and there is recent TLR activity on a Flowgate.

As Reciprocal Entities gain more experience in this process, implement and enhance their systems to perform the Firm Flow calculations and Allocations, they may change the timing requirements for the Forward Coordination Process by mutual agreement.

6.6.1 Determining Firm Transmission Service Impacts

Firm impacts used in the Allocation process incorporate the Firm Transmission Service flows. Similar to the network service calculation described previously, to calculate each Firm Transmission Service transaction's impact on the Flowgate, the following process is utilized:

1. Utilize a base case to determine the Generation Shift Factor for the source Control Area with respect to a specific Flowgate.
2. Utilize the same base case to determine the Generation Shift Factor for the sink Control Area with respect to that Flowgate.
3. Utilize superposition to calculate the TDF for that source to sink pair with respect to that Flowgate.
4. Multiply the transactions energy transfer by the TDF to determine that transactions flow on the Flowgate.

Summing each of these impacts by direction will provide the directional Firm Transmission Service impact on the Flowgate.

Combining the directional Firm Transmission Service impacts with the directional NNL impacts will provide the directional Firm Flows on the Flowgate.

6.6.2 Rules for Considering Firm Transmission Service

1. Firm Transmission Service and Designated Network Resources that have an OASIS reservation are included in the calculation.
2. Reciprocal Entities will utilize a Freeze Date of April 1, 2004. Reciprocal Entities will utilize a reference year of June 1, 2004 through May 31, 2005 for determining the confirmed set of reservations that will be used in the Allocation process. The reference year is used such that reservation impacts in a given month in the reference year are used for each comparable month going forward in the Allocation process. For example, the Allocations for July 2004, July 2005, and July 2006 etc. will always use the July 2004 reservation impacts from the reference year. Confirmed reservations received after the Freeze Date will not be considered.
3. A potential for duplicate reservations exists if a transaction was made on individual CA tariffs (not a regional tariff) and both parties to the transaction (source and sink) are Reciprocal Entities. In this case, each Reciprocal Entity will receive 50% of the transaction impact.
4. To the extent a partial path reservation is known to exist, it will have 100% of its impacts considered on Reciprocal Coordinated Flowgates owned by the party that sold the partial path service, split 50/50 between the Source Reciprocal Entity and the Sink Reciprocal Entity, and 0% of its impacts considered on other Reciprocal Coordinated Flowgates.
5. Because reservations that are totally within the footprint of the regional tariff do not have duplicate reservations, these reservations will have the full impact considered even

though both parties to the transaction (source and sink) are within the boundaries of the regional tariff and will be considered Reciprocal Entities, split 50/50 between the Source Reciprocal Entity and the Sink Reciprocal Entity, which in this case are the same. Similar to the firm network service calculation, the Firm Transmission Service calculation:

- a. Will consider all reservations (including those with less than 5% impact)
- b. Will base response factors on the topology of the system for the period under consideration.
- c. In general, will not make a generation-to-load calculation where a reservation exists.

6.6.3 Limiting Firm Transmission Service

The Flowgate Allocations down to 0% will represent the share of total flowgate capacity (STFC) that a particular entity has been allocated. This STFC represents the maximum total impact that entity is allowed to have on that Flowgate.

In order to coordinate with the existing AFC process, it is necessary that this number be converted to an available STFC (ASTFC) which represents how much Flowgate capability remains available on that Flowgate for use as Transmission Service. In order to accomplish this, the entity receiving STFC will do the following:

Step	Example
1.) Start with the STFC	100
2.) Add all forward Gen to Load impacts (down to 0%) and all Reverse Gen to Load impacts (down to 0%) to obtain the Net Gen to Load impacts. The Gen to Load impacts should be based on the <i>best estimate</i> of firm Gen-to-Load Flow for the time period being evaluated.	$42 + (-20) = 22$
3.) Subtract the net Gen to Load impacts from the STFC	$100 - 22 = 78$
4.) Subtract the CBM to produce an interim STFC	$78 - 0 = 78$
5.) Determine the Transmission Service impacts of service that has been sold. By default, it should be assumed that 100% of forward service and 15% of counterflowing service will be scheduled and used. However, if Flowgate "owner" uses different percentages in their AFC calculation and the Flowgate manager's calculation	$58 + (0.15 (-45)) =$ $58 + (-6.75) \approx$ $58 + (-7) = 51$

<p>engine support it, percentages other than 100% and 15% may be used. Add all forward Transmission Service impacts (down to 0%) and all appropriate reverse Transmission Service impacts (down to 0%) to obtain the weighted net Transmission Service impacts. The Transmission Service impacts should be based on the <i>current</i> set of reservations in effect for the time period being evaluated (<i>not</i> the historic reservation set)</p>	
<p>6.) Subtract the weighted net Transmission Service impacts from the Interim STFC. The result is the ASTFC</p>	<p>$78 - 51 = 27$</p>

The ASTFC values for Reciprocal Coordinated Flowgates will be posted on OASIS along with the Allocation results. This ASTFC can then be compared with the AFC calculated through traditional means when evaluating firm requests made on OASIS.

If the AFC value is LOWER than the ASTFC value, the AFC value should be utilized for the purpose of approving/denying service. In this case, while the Allocation process might indicate that the entity has rights to a particular Flowgate through the Allocation process, current conditions on that Flowgate indicate that selling those rights would result in overselling of the Flowgate, introducing a reliability problem.

If the AFC value is HIGHER than the ASTFC value, the ASTFC value should be utilized for the purpose of approving/denying service. In this case, while the AFC process might indicate that the entity can sell more service than the Allocation might indicate, the entity is bound to not sell beyond their Allocation.

If a Reciprocal Entity uses all of its firm Allocation and desires to obtain additional capacity from another Reciprocal Entity who has remaining capacity, that additional capacity may be obtained using the procedures documented below.

6.7 Sharing or Transferring Unused Allocations

Reciprocal Entities shall use the following process for the sharing or transferring of unused Allocations down to 0% between each other.

6.7.1 General Principles

This process includes the following general principles in the treatment of unused Allocations

1. A desire to fully utilize the Reciprocal Entities' Allocations such that in real-time, an unused Allocation by Reciprocal Entities is caused by a lack of commercial need for the Allocation by Reciprocal Entities and not by restrictions on the use of the Allocation.
2. For short-term requests (less than one year) where the lack of an Allocation could otherwise result in the denial of Transmission Service requests, there should be a mechanism to share or acquire a remaining Allocation on a non-permanent basis for the duration of the short-term transmission service requests. The short-term Allocation transfers would revert back to the Reciprocal Entity with the original Allocation after the short term request expires.
3. For long-term requests (one year or longer) where the lack of an Allocation could otherwise cause the construction of new facilities, there should be a mechanism to acquire a remaining Allocation such that new facilities are built only because they are needed by the system to support the transaction and not because of the Allocation split between Reciprocal Entities. Long-term Allocation transfers would apply to the original time period of the request including any roll-over rights that are granted for such requests.
4. Due to limitations on the frequency of transferring updated Allocation values and AFC's between the Reciprocal Entities, the Reciprocal Entities will utilize buffers to reduce the risk of overselling the same service, and to set aside a portion of the unused Allocation for the owner of the unused Allocation to accommodate any request that they may receive. The buffer will be reduced on a Flowgate based upon factors such as the rating of the Flowgate and operational experience, with the goal to maximize the use of the unused Allocation. The rationale for reducing the buffer is that potentially significant amounts of Transmission Service (up to many times the buffer amount) may be denied otherwise by the non-owner of the unused Allocation.

6.7.2 Provisions for Sharing or Transferring of Unused Allocations:

1. Based upon the proposed infrastructure for Allocation calculations, daily Allocations are available for 7 days into the future and Weekly and Monthly Allocations are available up to 18 months into the future. Sharing and transferring of unused Allocations will be limited to the granularity of the Allocation calculations.

2. The Reciprocal Entities will share or transfer their unused firm Allocations during the time periods up until day ahead with the goal to fully utilize the Allocations.
3. This sharing or transfer of the unused Allocation will occur automatically for short-term Transmission Service requests, and manually for long-term (one year or greater) Transmission Service requests. The Reciprocal Entity that has been requested to transfer unused Allocations to the other Reciprocal Entity for a long-term request shall respond within 5 business days of receipt of the transfer request.
4. The Reciprocal Entities will post information available to the other Reciprocal Entity on all requests granted that shared or acquired the other Reciprocal Entity's Allocation on a daily basis for review.

5. Sharing an Unused Allocation During the Near-Term

The Reciprocal Entities will share their Allocations during the near-term (the first 7 days up until day ahead or a mutually agreed upon timeframe) with the goal to fully utilize the Allocations once in real-time through an automated process.

This sharing of the unused Allocation during the near-term will occur such that an unused Allocation that has not already been committed for use by either Firm Transmission Service or for market service will be made available to the other Reciprocal Entities for their use to accommodate Firm Transmission Service requests submitted on OASIS.

Other firm uses of the transmission system involving generation to load deliveries, which are not evaluated via automated request evaluation tools, will be handled via off-line processes. The core principles to be applied in such cases include:

- a. A sharing of Allocation can occur.
- b. The sharing shall be done on a comparable basis for the market and non-market entities.
- c. The sharing is not related to projected Market Flow absent new DNRs or Transmission Service submitted on OASIS.
- d. The details of the process will include such items as which DNRs are covered, time-lines for designations and comparable evaluation of DNRs. If the details of this process can not be agreed upon, there shall be no sharing of the unused Allocations during the near-term.

A buffer will limit the amount of Allocation that can be shared for short-term requests during automated processing of the Allocation sharing process. The owner of the unused Allocation is not restricted by the buffer. The buffer is defined as a percentage of the last updated unused Allocation, provided that the buffer shall not be allowed to be less than a certain MW value. For example, a 25% or 20 MW buffer would mean that the requesting entity can use the other Reciprocal Entity's unused Allocation while making sure that the other entity's unused Allocation does not become smaller than 25% of the reported unused amount or 20 MW. The specific provisions of the buffer shall be mutually agreed to by the Reciprocal Entities prior to implementing a sharing of unused Allocation. The buffer will not be used in manual processing of Allocation

sharing requests. For manual processing of requests, the owner of the unused Allocation will share the remaining unused Allocation to the extent they do not need the unused Allocation for pending Transmission Service requests.

For the sharing of unused Allocations in the near-term, the Allocations are not changed and should congestion occur the NERC IDC obligations for the giving Reciprocal Entity will be in accordance with its original Allocation. The receiving Reciprocal Entity will not be required to retract or annul any service previously granted due to the sharing of Allocations.

6. Acquiring an Unused Allocation Beyond the Near Term

When a Reciprocal Entity does not have sufficient Allocation on a Flowgate to approve a firm point-to-point or network service request made on OASIS and evaluated via automated request evaluation tools and the other Reciprocal Entity has a remaining Allocation, the deficient Reciprocal Entity will be able to acquire an Allocation from the Reciprocal Entity with the remaining Allocation. This Allocation must not already be committed for other appropriate uses, as agreed to by the Reciprocal Entities, and sufficient AFC must remain on the Flowgate, or will be created, to accommodate the request. Such cases will be handled via automated processes.

Other firm uses of the transmission system involving generation to load deliveries, which are not evaluated via automated request evaluation tools, will be handled via off-line processes. The core principles to be applied in such cases include:

- a. A transfer of Allocation can occur.
- b. The transfer shall be done on a comparable basis for the market and non-market entities.
- c. The transfer is not related to projected market flow absent new DNRs or Firm Transmission Service submitted on OASIS.
- d. The details of the process will include such items as which DNRs are covered, time-lines for designations and comparable evaluation of DNRs. If the details of this process can not be agreed upon, there shall be no transfer of the Allocation for the time period beyond the near term.

A buffer will limit the amount of Allocation that can be acquired for these requests during automated processing of the Allocation transfer process. The owner of the unused Allocation is not restricted by the buffer. The buffer is defined as a percentage of the last updated unused Allocation, provided that the buffer shall not be allowed to be less than a certain MW value. For example, a 25% or 20 MW buffer would mean that the requesting entity can use the other Reciprocal Entity's unused Allocation while making sure that the other entity's unused Allocation does not become smaller than 25% of the reported unused amount or 20 MW. The specifics of the buffer shall be mutually agreed to by the Reciprocal Entities prior to implementing a transferring of unused Allocation. The buffer will not be used in manual processing of Allocation sharing requests. For manual processing of requests, the owner of the unused Allocation will

transfer the remaining unused Allocation to the extent they do not need the unused Allocation for pending Transmission Service requests.

The determination of whether the remaining Allocation has already been committed will be established based on OASIS queue time. All requests received prior to the queue time will be considered prior commitments to the remaining Allocation, while such requests are in a pending state (e.g. study status) or confirmed state. Requests received after the queue time will be ignored when determining whether remaining capacity has already been committed.

In the event that prior-queued requests are still in a pending state (i.e. not yet confirmed), the Reciprocal Entity requesting a transfer of unused Allocations may await the resolution of any prior-queued requests in the other Reciprocal Entity's OASIS queue before relinquishing its ability to request an Allocation transfer.

For the transfer of unused Allocations, the Reciprocal Entity's Allocations will be changed to reflect the Allocation transfer at the time the Allocation transfer request is processed. To the extent the request is not ultimately confirmed, the Allocation will revert back to the original Reciprocal Entity with the remaining Allocation. For yearly requests, the transfer of the Allocation applies to the original time period of the request including any roll-overs that are granted.

6.8 Market-Based Operating Entities Quantify and Provide Data for Market Flow

In addition to the responsibilities described earlier in “Market-Based Operating Entity Congestion Management” Section 5 of this document, Market-Based Operating Entities will have an additional obligation, on Reciprocal Coordinated Flowgates, to further quantify their Non-Firm Flows into two (2) separate priorities: Non-Firm Network (6-NN), and Non-Firm Hourly (2-NH). Priorities will be determined as follows:

1. If the Market Flow exceeds the sum of the Firm Flow Limit and the 6-NN Allocation, then:
 - 2-NH = Market flow – (Firm Flow Limit + 6-NN Allocation)
 - 6-NN = 6-NN Allocation
 - 7-FN = Firm Flow Limit
2. If the Market Flow exceeds the Firm Flow Limit but is less than the 6-NN Allocation, then:
 - 2-NH = 0
 - 6-NN = Market Flow – Firm Flow Limit
 - 7-FN = Firm Flow Limit
3. If the Market Flow does not exceed the Firm Flow Limit, then
 - 2-NH = 0
 - 6-NN = 0
 - 7-FN = Market Flow

All other aspects of this data remain identical to those described in “Market-Based Operating Entity Congestion Management” Section 5.

6.9 Real-time Operations Process for Market-Based Operating Entities

6.9.1 Market-Based Operating Entity Capabilities

Capabilities remain as described in “Market-Based Operating Entity Congestion Management” Section 5.

6.9.2 Market-Based Operating Entity Real-time Actions

Procedures remain as described in “Market-Based Operating Entity Congestion Management” Section 5. However, as described above, additional information regarding the firmness of those Non-Firm Market Flows will be communicated as well. A portion will be reported as 6-NN, while the remainder will be reported as 2-NH. This will provide additional ability for the IDC to curtail portions of the Non-Firm Market Flows earlier in the TLR process.

Section 7 – Appendices

Appendix A – Glossary

Allocation – A calculated share of capability on a Reciprocal Coordinated Flowgate to be used by Reciprocal Entities when coordinating AFC, transmission sales, and dispatch of generation resources.

Available Flowgate Capability (AFC) – the applicable rating of the applicable Flowgate less the projected loading across the applicable Flowgate less TRM and CBM. The firm AFC is calculated with only the appropriate Firm Transmission Service reservations (or interchange schedules) in the model, including recognition of all roll-over Transmission Service rights. Non-firm AFC is determined with appropriate firm and non-firm reservations (or interchange schedules) modeled.

AFC Flowgate – A Flowgate for which an entity calculates AFC's.

Control Area – Shall mean an electric power system or combination of electric power systems to which a common automatic generation control scheme is applied.

Control Zones – Within an Operating Entity Control Area that is operating with a common economic dispatch, the Operating Entity footprint is divided into Control Zones to provide specific zonal regulation and operating reserve requirements in order to facilitate reliability and overall load balancing. The zones must be bounded by adequate telemetry to balance generation and load within the zone utilizing automatic generation control.

Coordinated Flowgate (CF) – shall mean a Flowgate impacted by an Operating Entity as determined by one of the four studies detailed in Section 3 of this document. For a Market-Based Operating Entity, these Flowgates will be subject to the requirements under the Congestion Management portion of this document (Sections 4 and 5). A Coordinated Flowgate may be under the operational control of a Third Party.

Designated Network Resource – A resource that has been identified as a designated network resource pursuant to a transmission provider's Open Access Transmission Tariff.

Firm Flow – The estimated impacts of Firm Transmission Service on a particular Coordinated or Reciprocal Coordinated Flowgate.

Firm Flow Limit – The maximum value of Firm Flows an entity can have on a Coordinated or Reciprocal Coordinated Flowgate, based on procedures defined in Sections 4 and 5 of this document.

Firm Market Flow – The portion of Market Flow on a Coordinated or Reciprocal Coordinated Flowgate related to contributions from the native load serving aspects of the dispatch (constrained as appropriate by the Firm Flow Limit).

Firm Transmission Service – The highest quality (priority) service offered to customers under a filed rate schedule that anticipates no planned interruption or similar quality service offered by

transmission providers by contract that do not require the filing of a rate schedule. Firm Transmission Service only includes firm point-to-point service, network designated transmission service and grandfather agreements deemed firm by the transmission provider as posted on OASIS.

Flowgate – A representative modeling of facilities or groups of facilities that may act as significant constraint points on the regional system.

Freeze Date – the cutoff date chosen by Reciprocal Entities to be used in the calculation of Historic Firm Flows.

Gen to Load (GTL) – See Network and Native Load.

Generator Shift Factor – A factor to be applied to a generator’s expected change in output to determine the amount of flow contribution that change in output will impose on an identified transmission facility or Flowgate, referenced to a swing bus.

Historic Firm Flow – The estimated total impact an entity has on a Reciprocal Coordinated Flowgate when considering the impacts of (1) its historic Designated Network Resources serving native load, and (2) imports and exports, based on Firm Transmission Service reservations that meet the “Freeze Date” criteria.

Historic Firm Gen-to-Load Flow – The flow associated with the native load serving aspects of dispatch that would have occurred if all Control Areas maintained their current configuration and continued to serve their native load with their generation.

Historic Ratio – The ratio of Historic Firm Flow of one Reciprocal Entity compared to the Historic Firm Flow of all Reciprocal Entities on a specific Reciprocal Coordinated Flowgate.

LMP Based System or Market – An LMP based system or market utilizes a physical, flow-based pricing system to price internal energy purchases and sales.

Load Shift Factor – A factor to be applied to a load’s expected change in demand to determine the amount of flow contribution that change in demand will impose on an identified transmission facility or Flowgate, referenced to a swing bus.

Locational Marginal Pricing (LMP) – the processes related to the determination of the LMP, which is the market clearing price for energy at a given location in a Market-Based Operating Entity’s market area.

Market Flows – The calculated energy flows on a specified Flowgate as a result of dispatch of generating resources serving market load within a Market-Based Operating Entity’s market.

Market-Based Operating Entity – An Operating Entity that operates a security constrained, bid-based economic dispatch bounded by a clearly defined market area.

Network and Native Load (NNL) – the impact of generation resources serving internal system load, based on generation the network customer designates for Network Integration Transmission Service (NITS). NNL is also referred to as Gen to Load.

Non-Firm Market Flow – That portion of Market Flow related to a Market-Based Operating Entity’s market operations in excess of that entity’s Firm Market Flow.

Operating Entity – An entity that operates and controls a portion of the bulk transmission system with the goal of ensuring reliable energy interchange between generators, loads, and other operating entities.

Reciprocal Coordination Agreement – An agreement between Operating Entities to implement the reciprocal coordination procedures defined in the CMP.

Reciprocal Coordinated Flowgate (RCF) – A Flowgate that is subject to reciprocal coordination by Operating Entities, under either this Agreement (with respect to Parties only) or a Reciprocal Coordination Agreement between one or more Parties and one or more Third Party Operating Entities. An RCF is:

1. A CF that is (a) (i) within the operational control of Reciprocal Entity or (ii) may be subject to the supervision of Reciprocal Entity as Reliability Coordinator, and (b) affected by the transmission of energy by two or more Parties; or
2. A CF that is (a) affected by the transmission of energy by one or more Parties and one or more Third Party Operating Entities, and (b) expressly made subject to CMP reciprocal coordination procedures under a Reciprocal Coordination Agreement between or among such Parties and Third Party Operating Entities; or
3. A CF that is designated by agreement of both Parties as an RCF.

Reciprocal Entity – an entity that coordinates the future-looking management of Flowgate capacity in accordance with a Reciprocal Coordination Agreement as developed under Section 6 of this document, or a congestion management process approved by the Federal Energy Regulatory Commission; provided such congestion management process is identical or substantially similar to this Congestion Management Process.

Security Constrained Economic Dispatch – the utilization of the least cost economic dispatch of generating and demand resources while recognizing and solving transmission constraints over a single Market-Based Operating Entity Market.

Transfer Distribution Factor – the portion of an interchange transaction, typically expressed in per unit, that flows across a Flowgate.

Transmission Service – services provided to the transmission customer by the transmission service provider to move energy from a point of receipt to a point of delivery.

Appendix B - Determination of Marginal Zone Participation Factors

In order for the Interchange Distribution Calculator (IDC) to properly account for tagged transactions, a Market-Based Operating Entity using the Marginal Zone methodology will need to provide participation factors representing the facilities contributing to the tagged transactions. The facility or facilities contributing to each export tagged transaction is the source of the export tagged transaction. The facility or facilities contributing to each import tagged transaction is the sink of the import tagged transaction.

The Market-Based Operating Entity will be required to define a set of zones that can be aggregated into a common distribution factor that is representative of the market area. This information must be shared and coordinated with the IDC. Following this step, the Market-Based Operating Entity must then send to the IDC participation factors for those zones. These participation factors represent the percentages of how these zones are providing marginal megawatts as a result of dispatch of resources in market operations to serve transactions. Data sets for each external source/sink are required, which correspond to:

- An IMPORT data set, which indicates the participation of facilities accommodating the energy imported into the market area, and
- An EXPORT data set, which indicates the participation of facilities accommodating the energy exported out of the market area.

The methodology used by the Market-Based Operating Entity to determine the Marginal Zone participating factors will be determined through collaboration of the Market-Based Operating Entity with the IDC working group.

Participation Factor Calculation

The Market-Based Operating Entity will use the real-time system conditions to calculate the marginal zone participation factors, which reflect the impacts of tagged transactions. These will establish, for imports and exports, a set of participation factors that, when summed, will equal 100 percent.

Appendix C - Flowgate Determination Process

This section is has been added to clarify:

- How initial Flowgates are identified (Figure C-1, Table C-1)
 - Process for Flowgates in the Coordinated Flowgate list
 - Process for Flowgates in the Reciprocal Coordinated Flowgate list
 - Process for Flowgates in the AFC List
- How Flowgates will be added (Figure C-2, Table C-2)
- How often Flowgates are changed (Figure C-2, Table C-2)

Figure C-1
 Determine AFC Flowgates, Coordinated Flowgates, and Reciprocal Coordinated Flowgates

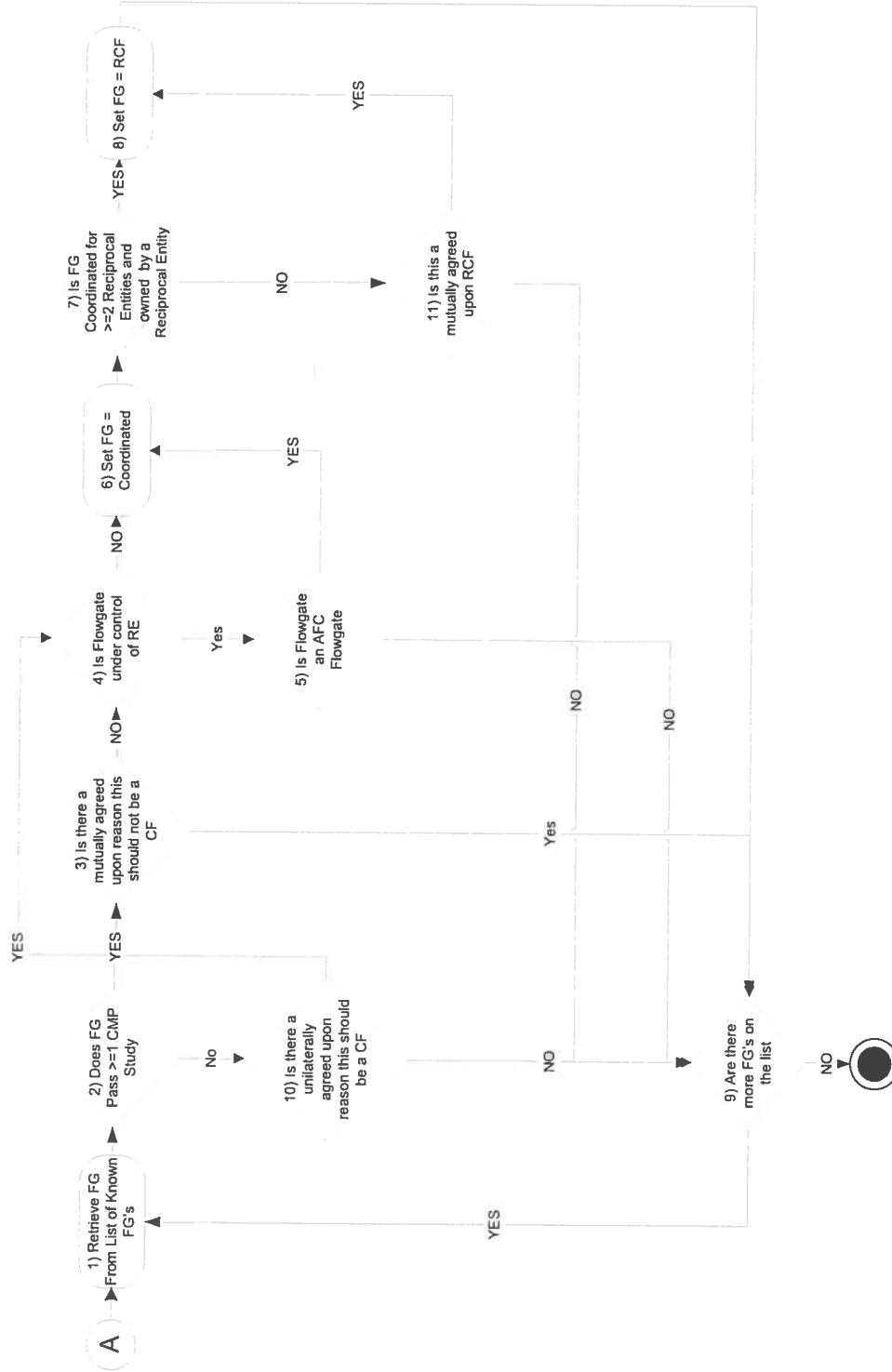

TABLE C-1

Step	Activity	Requirements	Detailed Description	Additional Documentation
1	Retrieve FG From List Of Known FG's	Retrieve FG from AFC list of FGs, NERC Book of FGs, and any other list of FGs.	<ul style="list-style-type: none"> Retrieve the FG from the list of FGs. If a Reciprocal Entity wants us to consider a temporary FG it would go through the same process. 	
2	Determine if FG passes >= 1 CMP Study	The decision determines if the FG passes at least one of the four CMP studies	<ul style="list-style-type: none"> If the FG passes any of the studies, determine if there is mutually agreed upon reason why this should not be a coordinated FG. If the FG does not pass any of the studies, it will be determined if there is a unilaterally decided reason for inclusion as a CF. 	See Impacted Flowgate Determination -Section 3
3	Is There a Mutually Agreed Upon Reason This Should Not Be A Coordinated Flowgate	Determine if there is a mutually agreed reason, despite passing one of the four tests, why this FG should not be considered Coordinated.	<ul style="list-style-type: none"> If there is no mutually agreed reason why this FG should not be considered coordinated, test whether FG is under control of a Reciprocal Entity. If there is a mutually agreed reason why this FG should not be considered coordinated, record the reason proceed to Step 9. 	
4	Is the Flowgate under control of a Reciprocal Entity	If the flowgate is under the control of a non-reciprocal entity and the Flowgate passes one of the four tests it will be treated as a coordinated Flowgate.	<ul style="list-style-type: none"> If the Flowgate is not under control of a Reciprocal Entity proceed to Step 6. If the Flowgate is under control of a Reciprocal Entity Proceed to Step 5. 	
5	Is Flowgate an AFC Flowgate	A check is done to determine if the Flowgate controlled by a Reciprocal Entity is in its AFC process. If it is not the Flowgate will not be treated as a Coordinated Flowgate.	<ul style="list-style-type: none"> If the Flowgate is in the AFC process proceed to Step 6. Otherwise proceed to Step 9 	
6	Set FG = Coordinated	The FG would be coordinated for the entity.	<ul style="list-style-type: none"> The FG would be considered a CF. 	

Step	Activity	Requirements	Detailed Description	Additional Documentation
7	Is FG Coordinated for >= 2 Reciprocal Entities and "owned" by a Reciprocal Entity	Determine whether the FG is coordinated for two or more Reciprocal Entities	<ul style="list-style-type: none"> If the FG is coordinated for two or more Reciprocal Entities and it is "owned" by one of the entities, it will be added to the CMP process as a reciprocal coordinated FG. If it is not coordinated for two or more Reciprocal Entities and "owned" by one of the entities, determine if it is a mutually agreed upon RCF. 	CM Process -Section 6
8	Set FG = RCF	Set the Flowgate equal to a Reciprocal Coordinated Flowgate.	<ul style="list-style-type: none"> Set the Flowgate equal to a Reciprocal Coordinated Flowgate. Proceed to Step 9. 	
9	Are there more FGs on the list?	Determine if there are any more FGs on the list that need to go through the CMP determination process.	<ul style="list-style-type: none"> If there are no more FGs that need to go through the determination process, the process ends. If there are more FGs that need to go through the determination process, retrieve the next one. Proceed to Step 1 if another FG requires evaluation. Otherwise, the process ends. 	
10	Is There a Unilateral Decision This Should Be A Coordinated FG	This decision determines if an entity wants to make this a Coordinated FG for a reason other than the four tests.	<ul style="list-style-type: none"> If an entity decides to make this a coordinated FG, proceed to Step 4. Otherwise, proceed to Step 9. 	
11	Is This a Mutually Agreed Upon RCF	Determine if there is a mutually agreed reason this should be considered a Reciprocal Coordinated Flowgate.	<ul style="list-style-type: none"> If there is no mutually agreed reason this should be considered an RCF, leave it as coordinated and check for more FGs. If there is a mutually agreed reason this should be considered an RCF, mark it as such. If Reciprocal Entities decide to make the Flowgate Reciprocal proceed to Step 8. Otherwise, proceed to Step 9. 	

Figure C-2
Flowgate Review and Customer
Flowgate Request

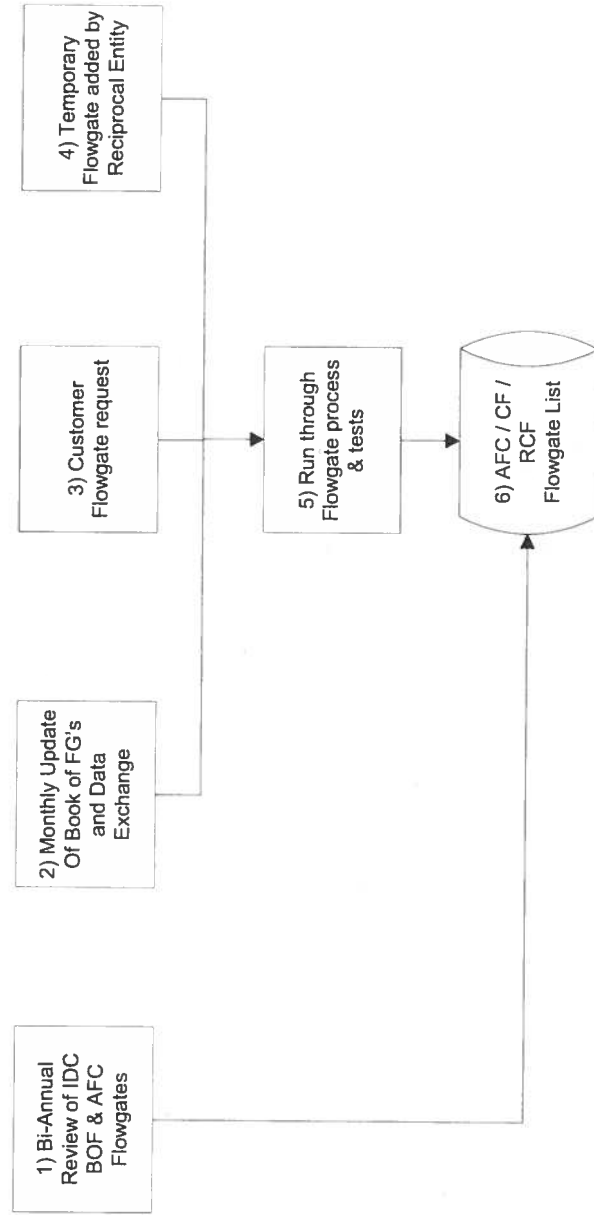

TABLE C-2

Steps	Activity	Requirements	Detailed Description	Additional Documentation
1	Bi-Annual Review of the BOFs and AFC FGs	Retrieve the FG from the list of FGs for the entity running the process.	<ul style="list-style-type: none"> Flowgate review should be done consistent with the IDC summer/winter base case changes, which would occur twice per year instead of Quarterly. Each base case update done at NERC for the IDC will need a certain amount of review just to make sure that current Flowgates will continue to function with the new model. The FGs will be run through the process summarized in figure C-1. 	
2	Monthly update of the Book of Flowgates and Data Exchange	Take monthly updates from book of Flowgates, monthly full files and monthly incremental files and run them through the Flowgate process and tests.	<ul style="list-style-type: none"> Monthly the Reciprocal Entities will perform full Flowgate updates and synchronization. In addition the NERC Book of Flowgates is updated once a month. We will run these changes through the process summarized in figure C-1. 	
3	Customer FG Requests	Any customer FG requests will also be subject to the tests and process above.	<ul style="list-style-type: none"> Any customer FG requests will be run through the process summarized in figure C-1. 	
4	Temporary Flowgate added by Reciprocal Entity	Any temporary Flowgate added by a Reciprocal Entity will also be subject to the tests and processes in Step 5.	<ul style="list-style-type: none"> Any temporary Flowgates added by a Reciprocal Entity will be run through the process summarized in figure C-1 	
5	Run Through FG Process and Tests	Run through FG Determination Process, figure C-1	<ul style="list-style-type: none"> Any FGs being reviewed or added will be run through the process summarized in figure C-1. 	
6	AFC/CF/RFCF List	Any FG additions or modifications would need to be committed to the repository of FGs and their qualifications.	<ul style="list-style-type: none"> Any FG additions or modifications would need to be committed to the repository of FGs, along with their qualifications. 	

Appendix D – Training

The concepts in these proposals should not have a significant impact upon system operators beyond the operators of the Operating Entity. The reason that this impact rests upon the Operating Entities is that the Operating Entities Operators will need to be trained to monitor and respond to the external Flowgates.

Reliability Coordinator (RC) Operator Training Impacts include:

1. The ability to recognize and respond to Coordinated Flowgates.
 - a. IDC outputs will show schedule curtailments and possible redispatch requirements.
 - b. Must be able to enter constraint in systems to provide the redispatch relief within 15 minutes.
 - c. Must be able to confirm that the required redispatch relief has been provided and data provided to the IDC.
2. Capability to enter Flowgates on the fly.

Other RC System Operators Training Impacts include:

1. The ability to take projected net system flows between an Operating Entity's Control Zones versus only tag data to run day-ahead analysis (data to be provided by the IDC).
2. Need to develop a working knowledge of how relief on a TLR Flowgate can come from both schedule changes and redispatch on a select set of Coordinated Flowgates.
3. Can coordinate with another RC Operator when the RC System Operator has a temporary Flowgate that they believe requires the implementation of the “Flowgate on the Fly” process.

Appendix E – Reserved

Appendix F – FERC RCF Dispute Resolution

RCF Dispute Resolution

If a Party has followed all processes in the disputed flowgate process outlined in section 3.2 and is dissatisfied with the ORS resolution of the flowgate dispute, the Party may refer the dispute to FERC’s Dispute Resolution Service for mediation, and upon a Party’s determination at any point in the mediation that mediation has failed to resolve the dispute, either Party may seek formal resolution by initiating a proceeding before FERC.

Option 2

Reserved for future use

Appendix G – Allocation Adjustment for New Transmission Facilities and/or Designated Network Resources (or Reserved)

Option 1

New Transmission Facilities that Do Not Involve New DNR or New Firm Transmission Service

Concept – To the extent a new transmission facility causes either a significant increase or a significant decrease in flow on a Reciprocal Coordinated Flowgate that change will be assigned to the party responsible for the new facility.

Significant impact is defined as a 3% change in flow that occurs to an OTDF Flowgate and a 5% change in flow that occurs to a PTDF Flowgate with the addition of the new facility. The 3% and 5% are measured as a percentage of the Flowgate TTC (sometimes called Total Flowgate Capability (TFC)). The 3% is based on the post-contingency flow of an OTDF Flowgate.

The allocation adjustment will be assigned to the party responsible for the new facility. Both the original allocation and the allocation adjustment are assigned to the Reciprocal Entities. When the term “party responsible for the new facility” is used in this process, it refers to the Reciprocal Entity with functional control of the new transmission facility. To the extent a group of transmission owners that install a new facility include multiple Reciprocal Entities’ Transmission Owners and the new transmission facility results in a change in transfer capability on one or more RCFs, these Reciprocal Entities will work in collaboration to determine appropriate adjustments to each Reciprocal Entity’s allocation on all significantly impacted RCFs.

An analysis will be performed both with and without the new facility to determine whether there is a significant impact on one or more RCFs. The analysis and any subsequent allocation adjustments will coincide with the expected in-service date of the new facility. The inclusion of the new transmission facility in such an analysis is dependent on having a commitment that the new facility has or is expected to receive all of the appropriate approvals and will be installed on the date indicated.

In order to qualify for an allocation adjustment, the new transmission facility must not only create a significant change in flows, it must also be a significant change to the transmission system (i.e. a new line or transformer that creates a significant change to flows on one of more RCFs). The addition of a new generator without transmission additions (other than the generation interconnection) is not covered by this process for new transmission facility additions. A change in the rating of an RCF may qualify as a significant change to the transmission system and be eligible to receive an allocation adjustment even though it does not result in a change in flows.

For stability limited Flowgates, a new generator, reactive device or change to a remedial action scheme may contribute to a change in the transfer limitation of stability limited Flowgates. Where this occurs and the addition is being made for the specific purpose of changing the transfer limitation of stability limited Flowgates, an allocation adjustment will be provided to the Reciprocal Entity responsible for the new generator, reactive device or change to a remedial action scheme. By receiving an allocation adjustment, this new generator, reactive device or

change to a remedial action scheme will not also be included in the historical usage calculation to avoid double-counting of the impacts.

Not all new transmission facilities that significantly impact RCFs involve a change in flows. A new facility may be added that changes the rating of an RCF but has minimal impact on the flow (i.e. reconductoring, replacing a WT or CT, replacing a transformer). In this case, each Reciprocal Entity's historical usage flow will remain constant but the rating of the Flowgate will either increase or decrease. The Reciprocal Entity responsible for the new facility will receive an allocation adjustment that either increases or decreases its original allocation based on its impact on the RCF.

There is an equity issue involving new transmission facilities that result in an increased rating. Where a new facility involves minimal cost change (such as replacing either a WT or CT, replacing a jumper, replacing a switch, changing a CT setting, etc.), there have already been significant costs incurred on a larger conductor that allows the increased rating to occur. As long as the Reciprocal Entity making the minimal cost change is also responsible for the conductor, it is the appropriate Reciprocal Entity to receive the allocation adjustment. However, if different Reciprocal Entities own the conductor versus are responsible for making the minimal cost change, there is an equity issue if the entire allocation adjustment is given to the Reciprocal Entity responsible for making the minimal cost change. The Reciprocal Entities shall negotiate a mechanism to share in the allocation adjustment.

New Transmission Facilities that Involve New DNR or New Firm Transmission Service

Where a new transmission facility is added as part of an approved new usage of the transmission system (either a new DNR or a new Firm Transmission Service), the Reciprocal Entity responsible for the new facility has two choices on the treatment of this combination. First, in recognition that they have addressed transmission concerns associated with the new DNR or new Firm Transmission Service, the combination of the new transmission facility and new DNR/Firm Transmission Service will be added to the base model used in the historic usage impact calculation. The new DNR or new Firm Transmission Service will be treated as if it met the Freeze Date. To the extent the new transmission facility and its associated new DNR or new Firm Transmission Service will not occur until a future time period, they will not appear in the historic usage impact calculation until after the in-service/start date. The inclusion of the new transmission facility and associated DNR/Firm Transmission Service is dependent on having a commitment that both have been approved and will occur on the date indicated. If no such commitment exists, these additions will not be included in the historic usage impact calculation. By making this choice to include the new transmission facility and DNR/Firm Transmission Service in the historic usage impact calculation, the NNL allocation will consider the impact of both. This may result in increased NNL allocation to all Reciprocal Entities after considering historic usage impacts (down to 0%). However, the Reciprocal Entity that builds the new transmission facility will not receive any special treatment (NNL allocation adjustment up or down) because of the new transmission facility. This inclusion of a new DNR or new Firm Transmission Service only applies where associated new transmission facilities have been added to accommodate the new transmission usage.

Second, the Reciprocal Entity that builds the new transmission facility associated with a new DNR or new Firm Transmission Service can receive an NNL allocation adjustment (either up or down) and must honor that allocation when they apply the new DNR or new Firm Transmission Service in their use of NNL allocations. This would be a two-step process where you determine the impact of the new transmission facility on a stand-alone basis to calculate any adjustments to the NNL allocations (the same process used if there is a new transmission facility but no new DNRs or new Firm Transmission Service). The new DNRs or new Firm Transmission Service will use the remaining NNL allocation that has not been committed to other uses.

The Reciprocal Entity responsible for the combination of new transmission facility and new DNR/Firm Transmission Service will make a single choice (either one or two) that applies to all RCFs that are significantly impacted by the combination. There is no opportunity to have a different selection on different RCFs that are all impacted by the same combination.

Option 2

Reserved for future use

Option 3

Appendix G – Allocation Adjustment for New Transmission Facilities

Concept: To the extent that a new transmission facility subject to cross-border cost allocation (cross-border transmission facility) creates incremental capacity on an existing Reciprocal Coordinated Flowgate (RCF) or to the extent the new facility becomes part of a new RCF pursuant to Section 9.4.3.2 of the JOA, rights to that additional capacity created on that RCF must match the cost allocation for the new cross-border facility.

Allocation Adjustments on Existing Reciprocal Coordinated Flowgates

The physical rights to any significantly impacted incremental capacity on existing RCFs, that is a result of the cross-border allocation process, (“allocation adjustment”), will be assigned to a Reciprocal Entity, for congestion management purposes, in proportion to the share of the costs that such Reciprocal Entity must pay under the cost allocation process in Section 9.4.3.2 of the JOA.

Significant impact is defined as a 3% change in flow that occurs to an OTDF Flowgate and a 5% change in flow that occurs to a PTDF Flowgate with the addition of the new facility. The 3% and 5% are measured as a percentage of the Flowgate TTC (sometimes called Total Flowgate Capability (TFC)). The 3% is based on the post-contingency flow of an OTDF Flowgate.

An allocation adjustment based on the share of costs that such Reciprocal Entity must pay under the cost allocation process in Section 9.4.3.2 of the JOA will apply only where there has been a significant decrease in flows on an existing RCF.

An analysis will be performed both with and without the new facility to determine whether there is a significant impact on one or more RCFs. The analysis and any subsequent allocation adjustments will coincide with the expected in-service date of the new facility. The inclusion of

the new transmission facility in such an analysis will be dependent upon having a commitment that the new facility has or is expected to receive all of the appropriate approvals and will be installed on the date indicated.

Appendix H – Application of Market Flow Threshold Field Test Conditions

MISO, PJM and SPP participated in a NERC approved Market Flow threshold field test from June 1, 2007 to October 31, 2009. The purpose of the field test was to determine a Market Flow threshold percentage that allows the three Regional Transmission Organizations (RTOs) to consistently meet their relief obligation during TLR without jeopardizing reliability. Although the field test was able to achieve a success rate close to 100% based on MISO data using a 5% threshold, the following conditions were applied to the field test results:

- Market Flows were evaluated 30 minutes after implementation of the TLR curtailment.
- A 5 MW dead-band (or 10% of the relief obligation for relief obligations greater than 50 MW) was applied to the Target Market Flow such that once actual Market Flows were within the dead-band, it was considered a success meeting the relief obligation.
- There were no instances where MISO was able to meet its relief obligation if more than 30 MW must be removed within 30 minutes. The field test found the amount of Market Flow that must be removed in 30 minutes and not the size of the relief obligation is an indicator whether the market will be successful.

Since the NERC ORS applied the three conditions above to the field test results in order to demonstrate a high success rate, these same conditions will be applied when the Market-Based Operating Entities have relief obligations on external flowgates during TLR.

The field test results are only applicable to Flowgates that are external to each of the RTOs and does not include internal Flowgates (internal to that specific RTO) or market-to-market Flowgates (internal to one of the three RTOs but subject to market-to-market provisions with another RTO). The reason for excluding internal Flowgates and market-to-market Flowgates is because the three RTOs use market redispatch to control total flow and to maintain reliability. As the Reliability Coordinator for the Flowgate, the three RTOs are responsible for the reliability of their own Flowgate and must manage total flow in order to meet their reliability responsibility. As described in the field test final report, by controlling total flow, the three markets effectively meet their relief obligation.